

1952-59 FORD CAR



2017
Sheet Metal, Tailight Lenses, Die Cast Emblems, Weather Stripping & more!



HIGHER QUALITY • LOWER PRICES



**Made Right,
Fits Right & Last Longer**

All of the parts in this catalog, with the exception of new old stock Ford parts, are reproduction or equivalent replacement type parts of Ford Motor Company parts and are represented or referenced by original Ford part numbers.



Reproduction Ford parts made from obsolete Ford tooling that are

licensed by but not manufactured by Ford are identified as Classic Parts From Original Tooling.



A reproduction part that duplicates a Ford licensed by but not manufactured by Ford is identified as an Official Licensed Product.

CARPENTER SHOWROOM



Be sure to visit our retail showroom in Concord, North Carolina, where you can purchase parts or browse our parts displays. We are located just 1 1/2 miles north of the Charlotte Motor Speedway.

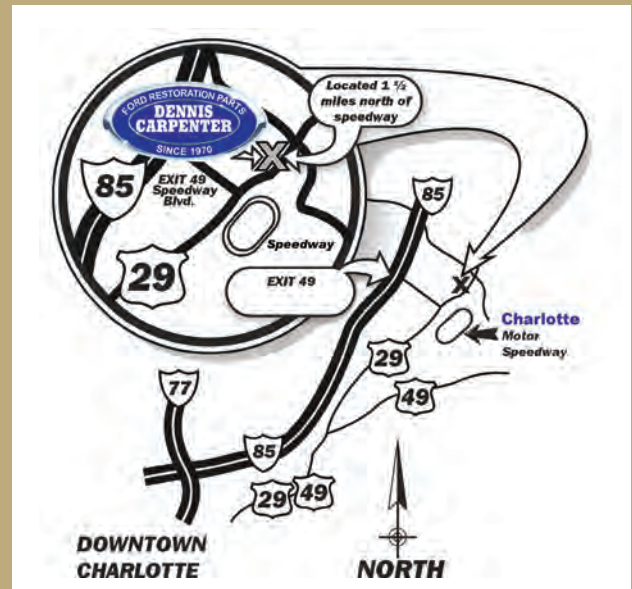

Showroom Hours: **Mon. - Fri. 8am - 5 pm • Sat 9am - 12 noon (EST)**

We attempt to maintain prices as published in the catalog. Due to the fact that we purchase materials from many manufacturers, we are not able to control all product costs. If the supplier goes up, we must raise our prices accordingly. As a result, our prices do change periodically and without notice. Please feel free to contact us for confirmation on current prices.

Errors in typographical content, pricing and imagery are subject to correction and may change without notice. C.I. will not be held liable or responsible if any inaccuracy exists in specifications or pricing. Applications listed in this catalog are based on original factory information. However, variances, will occur due to non-documented substitutions and changes made during the vehicles production.

This catalog supersedes all previous editions, including prices. All rights reserved. No part of this publication may be copied, reproduced, stored in any retrieval system, communicated or transmitted in any form by any means without prior approval.



Dennis Carpenter Ford Restorations is a manufacturer and retailer of restoration Ford Parts and Accessories. With Dennis Carpenters you can be sure you're getting a part that is made right, fits right and lasts longer at a great price.

→ **Dennis-Carpenter.com** ←

Order online 24 hrs. a day, 7 days a week, 365 days a year

PHONE ORDER Line

Mon. - Fri. 8am - 5 pm (EST)

1-800-476-9653

Orders Only (Toll Free) - Must have part numbers
Spanish speaking operators are also available!

PARTS ASSISTANCE Line

Mon. - Fri. 8am - 5 pm (EST)

704-786-8139

→ **Order via MAIL**

Dennis Carpenter
4140 Concord Parkway S.
Concord NC 28025

→ **Order via FAX Line**

704-786-8180

(use order form in back of catalog)

FREE PARTS CATALOGS

Call the Toll Free Phone Order line to request your catalog.

- 32-47 Ford Pickup
- 48-56 Ford Pickup
- 57-66 Ford Pickup
w/ Econoline
- 67-79 Ford Pickup
w/ 78-79 Bronco
- 66-77 Ford Bronco
- 80-96 Ford Pickup/Bronco
- 39-64 Ford Tractor

- 32-48 Ford/Mercury Car
- 49-51 Ford/Mercury Car
- 52-59 Ford/Mercury
- 1958-60 Edsel (online only)
- 55-66 Thunderbird
- 60-72 Galaxie/LTD
- 60-79 Fairlane/Falcon
- Cushman Motor Scooters

* allow 2-3 weeks for delivery

PAYMENT

Although personal checks are welcome, expect a two week delay in shipping to allow the check to clear the bank. Money orders, bank certified checks, Discover, MasterCard, Visa, and American Express may also be used. No C.O.D.'s.

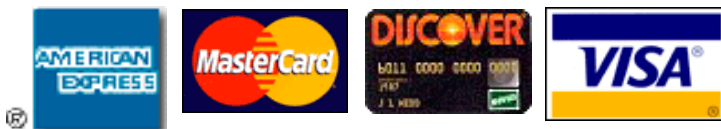

pg.9-17..... **WHEELS, HUBS & BRAKES**

Hub Caps , Wheel Bearings, Master Cylinder

pg.18-35..... **STEERING, SUSPENSION & REAR AXLE**

Ball Joints, Drag Links, Horn, Shackles

pg.36-55..... **ENGINE & TRANSMISSION**

Motor Mounts, Pistons, Oil Pump, Shifter

pg.56-61..... **RADIATOR & COOLING**

Mounting Pads, Hoses, Water Pumps, Thermostat

pg.62-69..... **FUEL SYSTEM**

Gas Tanks, Sending Units, Carburetor, Air Cleaner

pg.70-81..... **ELECTRICAL**

Alternator, Battery, Starter, Ignition

pg.82-103..... **LIGHTING & WIRING**

Headlight, Taillight, Back-up Light, Dome Light

pg.104-117..... **FENDER, HOOD & EXTERIOR**

Emblems, Wiper, Speedometer, Bumper, Antenna

pg.118-123..... **HEATER & A/C**

Defroster Hose, Heater Hose, Seal Kit

pg.124-133..... **DASH & INSTRUMENT BEZEL**

Knobs, Cluster Dials, Glove Box, Firewall

pg.134-146..... **WEATHER STRIPPING**

Windshield & Back Window Rubber, Door & Trunk Seals

pg.147-158..... **DOORS**

Anti-Rattlers, Handles, Vent Window, Door Lock

pg.159-168.... **QUARTER, TRUNK, ROOF**

Fender Skirt, Jack, Emblems, Roof Rails

pg.170..... **SHEET METAL**

Floor Pans, Rocker Panels, Trunk Pans

pg.174-183..... **DECALS & LITERATURE**

Shop Manuals, Parts Books, Sales Brochures

pg.184-192..... **CLIPS**

Body Side, Rocker Molding, Convertible Boot

* Show Schedule on page 171

Celebrating 47 Years

A look at how Dennis Carpenter Ford Restoration Parts has grown over the years.



1969

Dennis starts restoration on his 1940 Ford convertible, realizes the need for plastic knobs and convinces an antique car friend into developing tooling for making them. In this photo, Dennis' son Daniel stands beside his dad's disassembled Ford.



1970

Dennis takes extra dash knobs that he made to the Hershey AACA car show and sells out. Realizing that he is able to support his hobby, he continues to develop all dash knobs for 1932-48 Fords.

FIRST BUILDING

Purchased in 1973, it still stands today.

1971

Dennis takes out a 2nd mortgage on his house and buys a bigger injection molding machine for making better quality knobs in larger quantities. He moves his part time business from home into a rented vacant railroad depot.

1972

Dennis realizes that the weatherstripping and seals he purchased for his 1940 had hardened, cracked, and needed replacement after 6 months. He is determined to make premium quality weatherstripping for his 1940. Due to minimum production requirements, he starts selling the extras.



1973

Sales of his quality dash knobs and seals takes off, so he quits his full time job as a purchaser at a local textile plant. He buys a 5,000 sq. ft. building on Hwy 29 in Concord, NC, which is still located in the front of the business today. A late night train derailment forces a rush move into the building.

1974

Dennis purchases 25 acres of land behind his business for \$75,000.

1976

Dennis builds a 10,000 sq. ft. building next to the first one and remembers thinking that he was set for life as far as buildings go. Little did he know that it would eventually grow to be over 300,000 sq. ft.

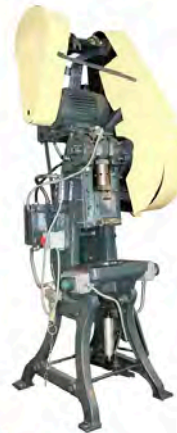

1977

Dennis purchases two used stamping presses for making stamped metal parts and a used die casting machine for making emblems.

1978

Dennis hires his first tool and die man for making tooling for more new parts. He also purchases his first new Bridgeport milling machine.



1979

Growth of the company continues, and he builds a 25,000 sq. ft. warehouse and showroom that are still in use today.



1987

Because of inconsistent size and hardness of rubber from outside suppliers, Dennis decides to develop his own rubber extruding operation from a desire to offer the very best quality weatherstripping and seals.





Daniel Carpenter and Dennis Carpenter

“Our company’s success is attributed to providing our customers with what they want- **quality products.**”

-DENNIS CARPENTER



1990

Dennis buys more plastic injection machines and develops more plastic parts. He also starts making Cushman Motor Scooter parts in an effort to keep his employees busy in a bad economy.



3001



1998

Ford Motor Company works with Dennis and his son Daniel on a pilot program to start using the original Ford tooling for parts they were no longer selling.



0001

1993

Ford Motor Company works with Dennis to become the first official Ford licensee for products made with the Ford name or logo on them.



1994

Dennis (the original American picker) fulfills a dream in building a museum to house his long time collection of Fords, Ford memorabilia, Cushman scooters, tractors, and Americana.

2000

The Original Ford Tooling program becomes official. We buy bigger machines and build more buildings to take in these large tools and run them. We continue to count it a privilege to have Ford’s trust and now have hundreds of original Ford tools in use. Ford traditionally scraps tools they are finished with. We are honored to save these tools from scrap for continued use, so we can make products for all the restorers out there that need them.

2003

Our biggest warehouse is built with 48,000 sq. ft. of high stack storage.



2005

Daniel Carpenter purchases the company from Dennis on a payment plan. Dennis is now able to focus on his core strength of developing new products and working with the tool makers.

2009

The economic downturn forces us to cut back and examine our ways but not one of our employees is laid off during the whole downturn. We are able to purchase some much needed equipment such as a digitizer and CNC machines at bargain prices from companies that were going out of business during this time.

2010

Edsel Ford II arrives at Carpenter Industries to tour the facilities.

2011

We transition to a new software and computer system after being on an old unix based system since 1991.

2013

We launch our all new user friendly web store and introduce flat rate shipping to better serve our customers.



Dennis still works at the business everyday and enjoys every bit of it. Also, those knobs and weatherstripping he put on his 1940 convertible back in the 1970s are still good to this day.

see our **quality products**
www.dennis-carpenter.com

For Orders Only: 1-800-476-9653
Shop Online at DENNIS-CARPENTER.COM



TYPICAL PATENT PLATE

thru 1959 **PATENT PLATE - TYPICAL**

Located on the left front body pillar.

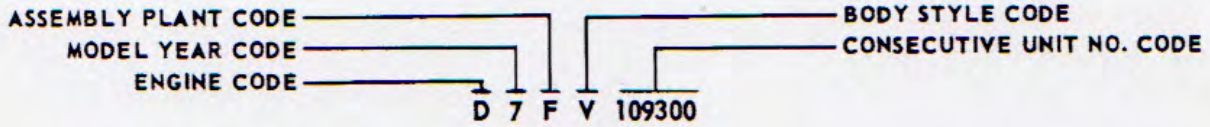

Serial Number (D7FV109300)

"D" -- 8 cyl. OHV Engine -- 312 cu. in. disp. -- 4-venturi carb.

"7" -- 1957 Model

"F" -- Assembled at Dearborn Plant

"V" -- Victoria body style -- Fairlane or Fairlane "500"

"109300" -- Nine thousand, three hundredth car assembled.

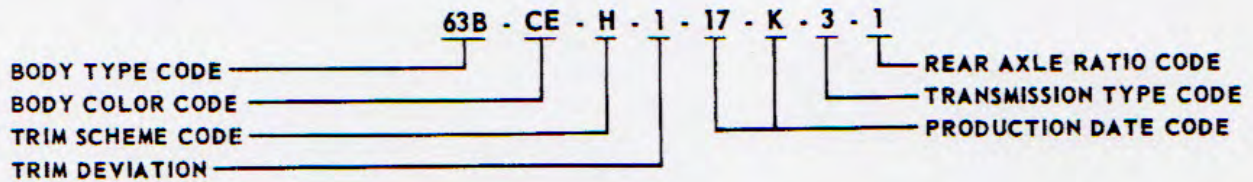
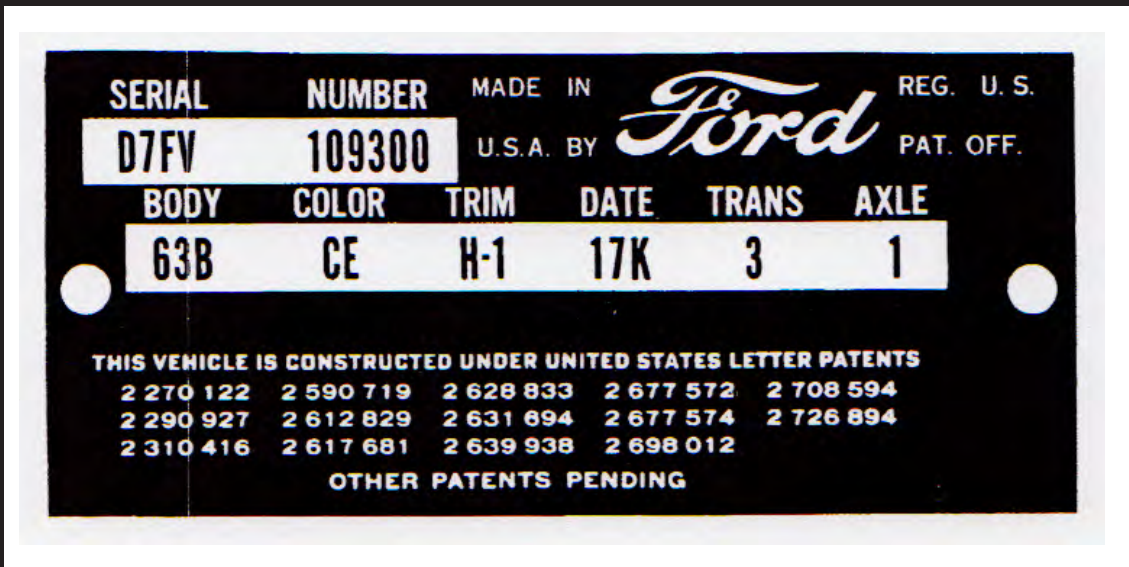

Body Style Codes Explained

Throughout our catalogs you will find Ford Body Code numbers. These numbers were used by Ford to designate what Body Styles a Ford part would fit.

For example, the Rocker Molding below would fit the Body Styles in the table that correspond to the Body Code #'s. If you find a Body Code # without a letter on the end that means that part fits all Body Codes with that number. So, a "65" fits "65A" & "65B".

ROCKER MOULDINGS

PART #	PIC	DESCRIPTION	YEAR	PRICE
C1MB-5410176-PR		- 54A,65,75,76	62	99.95 pr.

CODE	YEAR	DESCRIPTION
54A	60-61	Galaxie 4 Door Sedan
65A	61	Galaxie 2 Door Hardtop
75A	60-61	Galaxie 4 Door Hardtop
76B	62-64	Galaxie "500XL" Convertible

* Body codes are not shown on every single part.



BODY STYLE CODES

CODE	YEAR	DESCRIPTION
51A	57-58	Fairlane "500" Hide-Away Hardtop
51A	59	Galaxie Hide-Away Hardtop
54A	59	Galaxie Town Sedan
57A	56	Fairlane Fordor Victoria
57A	57-59	Fairlane "500" Town Victoria
57B	57-58	Fairlane Town Victoria
58A	57-59	Fairlane Town Sedan
58B	57-59	Fairlane "500" Town Sedan
58E	59	Custom "300" Fordor Sedan
59A	52-56	Mainline Ranch Wagon
59A	57-58	Tudor Ranch Wagon
59B	54-56	Customline Ranch Wagon
59B	57-58	Tudor Ranch Wagon "Del Rio"
59C	56	Fairlane Ranch Wagon
59C	59	Tudor Ranch Wagon
59D	59	Tudor Ranch Wagon "Country Sedan"
59E	59	Tudor Commercial Ranch Wagon "Courier"
60	50	Victoria
60B	52-54	Crestline Victoria
60B	55	Fairlane Victoria
60F	54	Crestline Skyliner
63A	57-59	Fairlane "500" Club Victoria
63B	57-58	Fairlane Club Victoria
64A	55-56	Fairlane Crown Victoria-Solid Top
64A	57-59	Fairlane Club Sedan
64B	55-56	Fairlane Crown Victoria Transparent Top
64B	57-59	Fairlane "500" Club Sedan
64C	56	Fairlane Victoria
64D	56	Customline Victoria
64F	59	Custom "300" Tudor Sedan
64G	59	Custom "300" Business Tudor
64H	59	Galaxie Club Sedan
65A	59	Galaxie Club Victoria
66A	57-59	Ranchero
66B	57-58	Ranchero
66C	59	Ranchero
70A	49	Ford Tudor Sedan
70A	50-51	Deluxe Tudor Sedan
70A	52-56	Mainline Tudor Sedan
70A	57	Custom Tudor Sedan
70A	58	Custom "30.0." Tudor Sedan
70B	49	Ford Custom Tudor Sedan
70B	50	Custom Deluxe Tudor Sedan
70B	51	Custom Tudor Sedan
70B	52-56	Customline Tudor Sedan
70B	57	Custom "30.0." Tudor Sedan
70B	58	Custom "30.0." Tudor Sedan (optional Interior Trim)
7DC	55-56	Fairlane Club Sedan

CODE	YEAR	DESCRIPTION
70D	55-56	Mainline Business Tudor
70D	57	Custom Business Tudor
70D	58	Custom "30.0." Business Tudor
71E	59	Station Wagon "Country Sedan"
71F	59	Station Wagon "Country Sedan" (6 passenger)
71G	59	Station Wagon "Country Squire" (9 passenger)
7tH	59	Fordor Ranch Wagon
72A	49	Ford Club Coupe
72B	49	Ford Custom Club Coupe
72B	50	Custom Deluxe Club Coupe
72B	51	Custom Club Coupe
72B	52-54	Customline Club Coupe
72C	49	Ford Business Coupe
72C	50-51	Deluxe Business Coupe
72C	52-54	Mainline Business Coupe
73A	49	Ford Fordor Sedan
73A	50-51	Deluxe Fordor Sedan
73A	52-56	Mainline Fordor Sedan
73A	57	Custom Fordor Sedan
73A	58	Custom "300" Fordor Sedan
73B	49	Ford Custom Fordor Sedan
73B	50	Custom Deluxe Fordor Sedan
73B	51	Custom Fordor Sedan
73B	52-56	Customline Fordor Sedan
73B	57	Custom "300" Fordor Sedan
73B	58	Custom "300" Fordor Sedan (optional Interior Trim)
73C	54	Crestline Fordor Sedan
73C	55-56	Fairlane Town Sedan
75A	59	Galaxie Town Victoria
76B	49	Ford Custom Convertible Coupe
76B	50	Custom Deluxe Convertible Coupe
76B	51	Custom Convertible Coupe
76B	52-54	Crestline Convertible Coupe
76B	55-56	Fairlane Convertible Coupe
76B	57-58	Fairlane "500" Convertible Coupe
76B	59	Galaxie Convertible Coupe (Sunliner)
78A	52-58	Sedan Delivery
79	49	Ford Custom Station Wagon
79	50	Custom Deluxe Station Wagon
79	50-51	Custom Station Wagon "Country Squire"
79A	58	Fordor Ranch Wagon
79B	52-55	Customline Station Wagon "Country Sedan"
79B	55	Customline Station Wagon "Country Sedan" (6 passenger)
79B	55-56	Fairlane Station Wagon "Country Sedan" (8 passenger)
79C	52-55	Crestline Station Wagon "Country Squire"
79C	55-56	Fairlane Station Wagon "Country Squire" (8 passenger)
79D	56	Customline Station Wagon "Country Sedan" (6 passenger)
79D	57-58	Station Wagon "Country Sedan" (6 passenger)
79E	57-58	Station Wagon "Country Squire" (9 passenger)

For Orders Only: 1-800-476-9653
 Shop Online at DENNIS-CARPENTER.COM

The difference between our wheel covers and original Ford wheel covers is



#B7A-1130-B
1957 passenger car polished stainless steel wheel cover.
Also standard on 1957 Thunderbirds.

no difference.

That's the beauty of parts made from Original Ford Tooling.

What does it take to make a hub cap?



This view shows several of the 180 ton presses used at Carpenter Industries to produce the 1957 wheel covers. A total of 9 stamping press operations are required to form a flat sheet of stainless steel into a one wheel cover. Here Dennis Carpenter looks on as production is in full swing. Other original Ford tooling wheel covers include those for 1955-56 cars and for 1967-72 Ford pickup trucks.



This is a closeup of the bottom half of the final embossing die. The results of this stamping operation gives the wheel cover it's distinctive turbine blade louvers and FORD lettering. The sheen seen on the die is caused by lubricant which is used during the stamping operation to aide the stretching of the stainless steel as it compresses between the dies.



Once the wheel covers are finally stamped they are packed and sent to an outside source to be annealed. This procedure relieves internal stresses introduced to the stainless steel by the stamping operations. After annealing each wheel cover is polished, covered with a coat of flash chrome to prevent yellowing, then finally sprayed with black and white paint for detailing.

HUB CAPS - FULL DISC

PART #	PIC	DESCRIPTION	SIZE	YEAR	PRICE
B5A-1130-C	A	Includes center Medallion	15" Diameter	55-56	109.95 ea.
B7A-1130-B	B	38 Embossments	14" Diameter	57	119.95 ea.
B9A-1130-A	C	36 Strut Design	14" Diameter	59	109.95 ea.
B9AB-1130-B	D	Includes Sun ray Emblem		59	169.95 ea.



HUB CAP ORNAMENT

Part #	B5A-1141-A
Type	Plastic
Note	
Fits	Full Disc Hub Caps
Year	1955-56
Price	24.95 ea.
Part #	BU-16228-A
Type	Plastic
Note	Fits Hub Cap & Front Fender
Fits	Body Type: #57,58,64,73,76,79
Year	1956 Mercury
Price	99.95 ea.



SUNRAY HUB CAP EMBLEM

Part #	B9A-1141-A
Type	<ul style="list-style-type: none"> • Plastic • Red, White, Blue • Die Cast Chrome Retainer
Note	Includes Templates & screws
Fits	B9AB-1130-B Hub Cap
Year	1959
Price	59.95 ea.



OUTER BEAUTY RINGS

PART #	PIC	DESCRIPTION	SIZE	YEAR	PRICE
6A-18303-15		Smooth Contoured Flare	- 15" Wheel		29.95 ea.
6A-18303-16		Smooth Contoured Flare	- 16" Wheel		29.95 ea.
01A-18303-15		Ribbed Type	- 15" Wheel		29.95 ea.
B4A-18303-B		NOS - White - Set of (4) Spring Mounted	- 15" Wheel	49-54	100.00 set

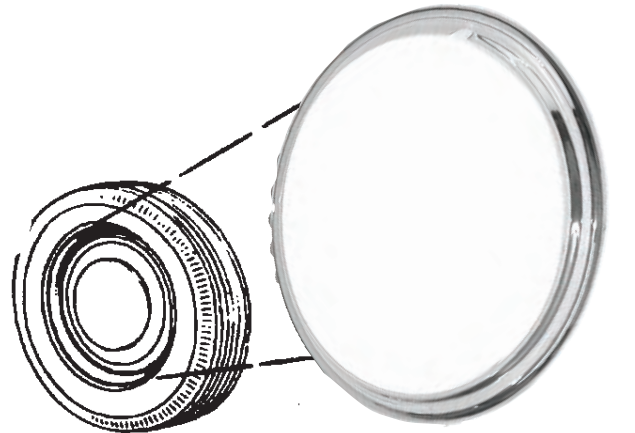

FRONT HUB BEARINGS & RACE

PART #	PIC	DESCRIPTION	YEAR	PRICE
Front Wheel INNER Bearing				
8A-1201	B	- Inner Bearing	49-54	15.95 ea.
B5A-1201	B	- Inner Bearing	55-59	9.95 ea.
Front Wheel OUTER Bearing				
8A-1216	C	- Outer Bearing	49-54	16.95 ea.
B5A-1216	C	- Outer Bearing	55-59	9.50 ea.
Front Wheel INNER Bearing Race				
8A-1202	D	- Inner Race	49-54	7.95 ea.
B5A-1202	D	- Inner Race	55-59	5.95 ea.
Front Wheel OUTER Bearing Race				
8A-1217	E	- Outer Race	49-54	7.95 ea.
B5A-1217	E	- Outer Race	55-59	7.95 ea.
Front Wheel Bearing & Race SET				
B5A-1201-PR		- Inner Bearing & Race - Takes (2) sets per car	55-59	14.95 set

FRONT WHEEL COTTER PIN

PART #	PIC	DESCRIPTION	YEAR	PRICE
*72054-S	F	Front Wheel Cotter Pin	ALL	0.25 ea.

FRONT HUB GREASE CAP & SEAL

PART #	PIC	DESCRIPTION	YEAR	PRICE
Front Hub Grease CAP				
B5A-1131-A	G	- 1-25/32" I.D. - Push-on	49-59	4.95 ea.
51A-1139	H	- 1-15/16" I.D. - Push-on	49-54	6.95 ea.
Front Hub Grease SEAL				
8A-1190-A	I	- 2 5/8 O.D. X 2 1/2 I.D.	49-53	5.95 ea.
B5A-1190-A	J		55-59	3.95 ea.

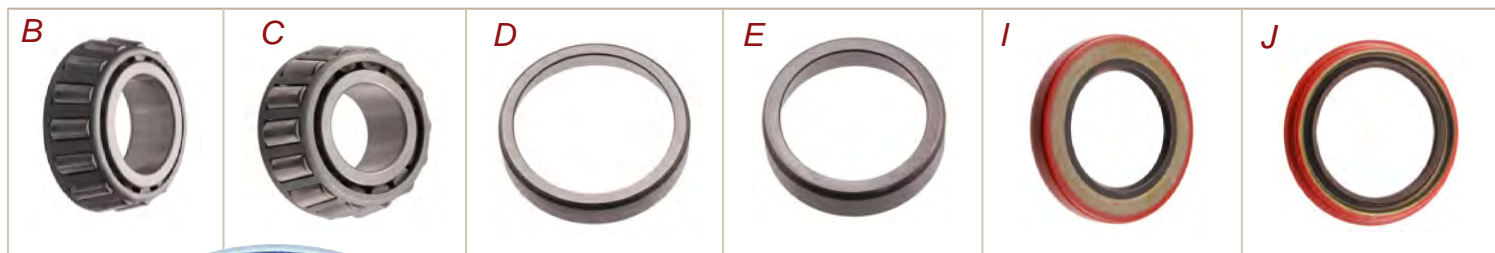
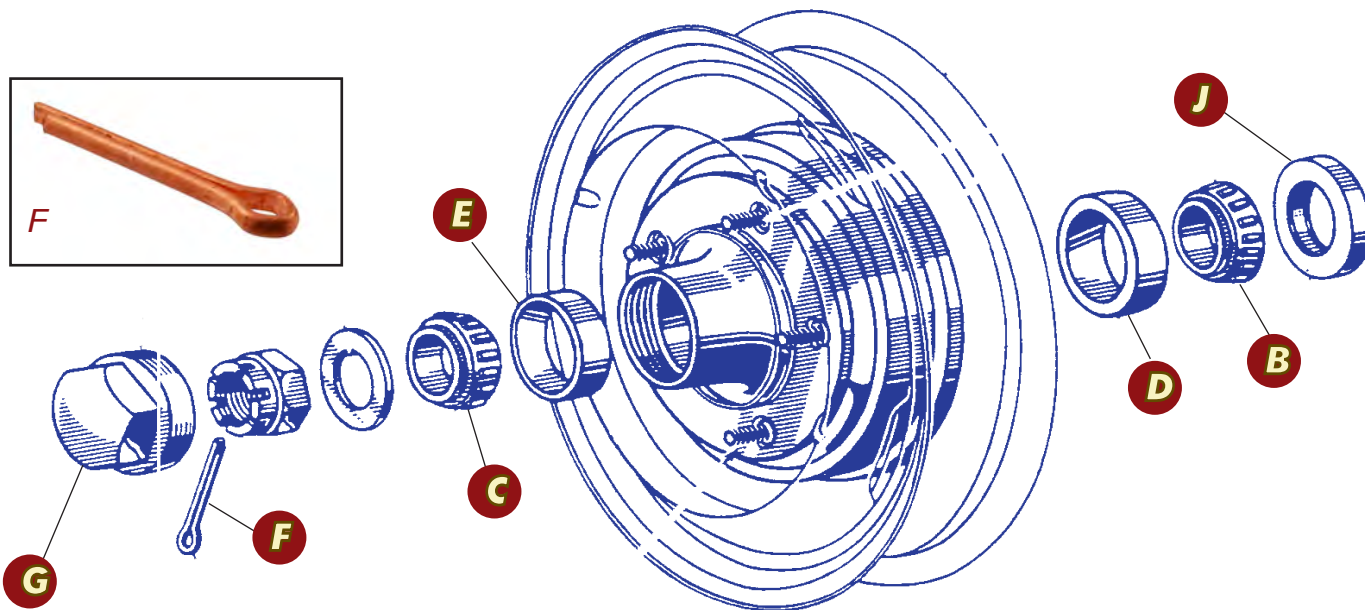

LUG NUT AND BOLT

Part #	8A-1107-A
Type	Lug Bolt
Note	For Rear Drums
Year	1949-57
Price	2.50 ea.



Part #	*B-1012
Type	Lug Nut
Year	1932-59
Price	0.50 ea.



Part #	E5TZ-1012-A
Type	Lug Nut
Note	Steel w/ Stainless Cap For Steel or Aluminum Sport Rims
Size	1/2" x 20 x 1 1/2"
Year	All
Price	5.95 ea.



LUG NUT PROTECTORS - Plastic

PART #	PIC	DESCRIPTION	YEAR	PRICE
P-1012		Wheel Nut Protectors To be used inside socket to protect chrome lug nuts Includes; (1) for 3/4" lug nut (1) for 13/16" lug nut	ALL	4.95 pr.



VALVE STEM EXTENSION

PART #	PIC	DESCRIPTION	YEAR	PRICE
8A-1705		Plastic Valve Stem Extension - 3/4" long - set of (4)	ALL	0.95 set



50,000 PART NUMBERS IN STOCK!

www.dennis-carpenter.com

SPARE TIRE HOLD DOWN WING NUT

PART #	PIC	TYPE	FIT	YEAR	PRICE
--------	-----	------	-----	------	-------

*BA-1457-A	K	Nut	Fits All Except Wagon, Sedan Delivery & Retractable	52-59	9.95 ea.
B9AZ-1462-A	L	Nut - 3/8" x 16		52-59	5.95 ea.

SPARE TIRE HOLD DOWN BOLT Anti-Rattler

BA-1458-S	M	Bolt Anti-Rattler - Rubber		52-54	0.95 ea.
-----------	---	----------------------------	--	-------	----------

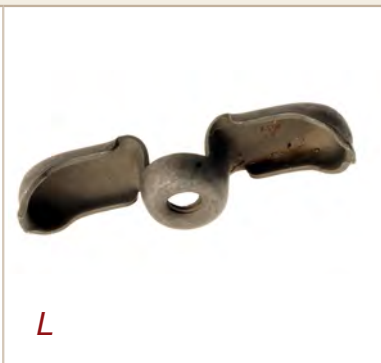

MASTER CYLINDER ASSEMBLY

PART #	PIC	FITS	Includes Plastic Cap	YEAR	PRICE
*B5A-2140	A		<input checked="" type="checkbox"/>	52-56	119.95 ea.
B7A-2140	B	All except w/ power brakes	<input checked="" type="checkbox"/>	57-59	139.95 ea.

A



B



MASTER CYLINDER CAP & GASKET

PART #	PIC	DESCRIPTION	YEAR	PRICE
AB-2162-C	C	Master Cylinder Cap	52-59	14.95 ea.
8M-2167	D	Master Cylinder Cap Gasket	49-59	1.95 ea.
0A-2180	E	Master Cylinder Boot	49-72	6.95 ea.

C



D



E



BRAKE MASTER CYLINDER PUSH ROD BEARING

Part #	B2A-2474-A
Fits	Goes on Push Rod Need (2) per car.
Year	1952-59
Price	4.95 ea.



BRAKE LIGHT SWITCH & PIGTAIL

PART #	PIC	DESCRIPTION	YEAR	PRICE
01A-13480	F	Brake Light Switch	40-59	7.95 ea.
B6A-13644-R	G	Female Pigtail - 90 degree (for Brake Light Switch)	40-79	3.95 pr.

F



G



Master Cylinder REPAIR KIT

WITHOUT Power Brakes

PART #	PIC	DESCRIPTION	SIZE	YEAR	PRICE
*B5A-2004-A	H	- without power brakes	1" dia	52-56	24.95 ea.
B7A-2004	I	- without power brakes	1" 1/16" dia	57-59	24.95 ea.

H



I



BRAKE SHOES & LINING SET

PART #	PIC	DESCRIPTION	FIT	SIZE	NOTE	YEAR	PRICE
154-2001-A	J	FRONT Brake Shoe & Lining Set	Passenger	10" x 2 1/4"	(4) pieces - does (1) axle	49-54	19.95 set
263-2001	K	FRONT Brake Shoe & Lining Set	Passenger	11" x 2 1/4"	(4) pieces - does (1) axle	55-59	19.95 set
55-2201	L	FRONT Brake Shoe & Lining Set	Station Wagon	11" x 1 3/4"	(4) pieces - does (1) axle	52-54	19.95 set
151-2201-A	M	REAR Brake Shoe & Lining Set	Passenger	10" x 1 3/4"	(4) pieces - does (1) axle	49-54	29.95 set
55-2201	L	REAR Brake Shoe & Lining Set	Passenger	11" x 1 3/4"	(4) pieces - does (1) axle	55-59	19.95 set
10-2001	N	REAR Brake Shoe & Lining Set	Station Wagon	11" x 2"	(4) pieces - does (1) axle	52-54	29.95 set



BRAKE SHOE HOLD DOWN KITS
(each kit does (2) wheels)

PART #	PIC	TYPE	FIT	YEAR	PRICE
BA-2065-S	O	FRONT & REAR	Passenger	52-54	9.95 kit
7C-2065-S		FRONT	Passenger	55-59	9.95 kit
7C-2065-S		FRONT & REAR	Wagon	52-54	9.95 kit
B5A-2065-S		REAR	Passenger	55-59	9.95 kit



BRAKE LINE CONNECTOR DISTRIBUTION BLOCK

Part #	8A-2074
Fits	Mounts on Rear Axle
Year	1949-56
Price	19.95 ea.



BRAKE DRUMS

PART #	PIC	DESCRIPTION	YEAR	PRICE
0A-1125-R		Front - Replacment Type	49-53	119.95 ea.
B5A-1125		Front - Fits all except Wagon	55-56	170.00 ea.
B5A-1125		Front - Fits all except Wagon	Mercury 52-54	170.00 ea.
AB-1126		Rear - All except Wagon	39-54	149.95 ea.
B5A-1126		Rear - Fits all except Wagon	55-56	170.00 ea.
B5A-1126		Rear - Fits all except Wagon	Mercury 52-54	170.00 ea.

BRAKE SHOE RETURN SPRING

(need 2) per wheel)

PART #	PIC	DESCRIPTION	YEAR	PRICE
8A-2035	A	Brake Shoe Return Spring	49-54	2.95 ea.
B5A-2035-A	B	Brake Shoe Return Spring	55-59	2.95 ea.

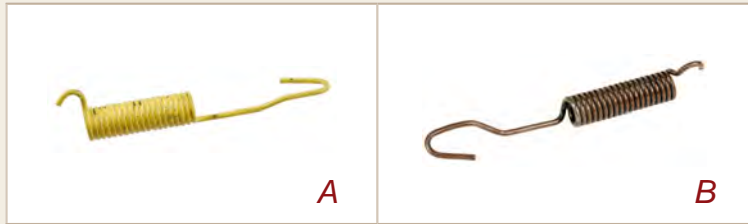

STAR WHEEL ADJUSTING SCREW

(need 1) per wheel)

PART #	PIC	DESCRIPTION	YEAR	PRICE
BA-2041-S	C	Star Wheel Adjusting Screw Assy.	49-54	9.95 ea.
B5A-2041-S	D	Star Wheel Adjusting Screw Assy.	55-59	9.95 ea.



BRAKE ADJUSTING SCREW

SOCKET & SPRING (need 1) per wheel)

PART #	PIC	DESCRIPTION	YEAR	PRICE
B7A-2048-A	E	Brake Adjusting Screw Socket	55-59	2.95 ea.
8A-2049	F	Brake Adjusting Screw Spring	49-54	8.95 ea.
B5A-2049	G	Brake Adjusting Screw Spring	55-59	5.95 ea.



BRAKE SHOE HOLD DOWN SPRING PIN

Part #	B7A-2069-A	
Type	Front Brake	
Note	Need (4) per axle	
Year	1955-59	
Price	0.75 ea.	

Front Brakes

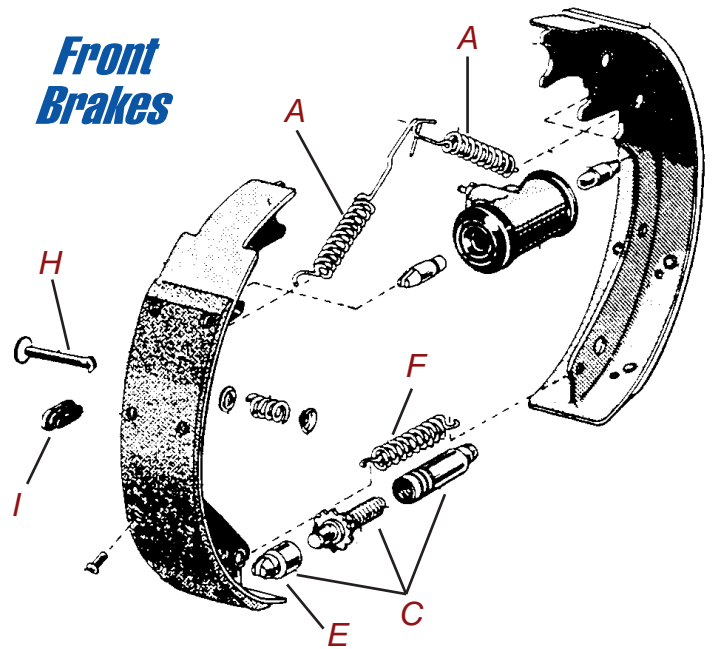

Rear Brakes

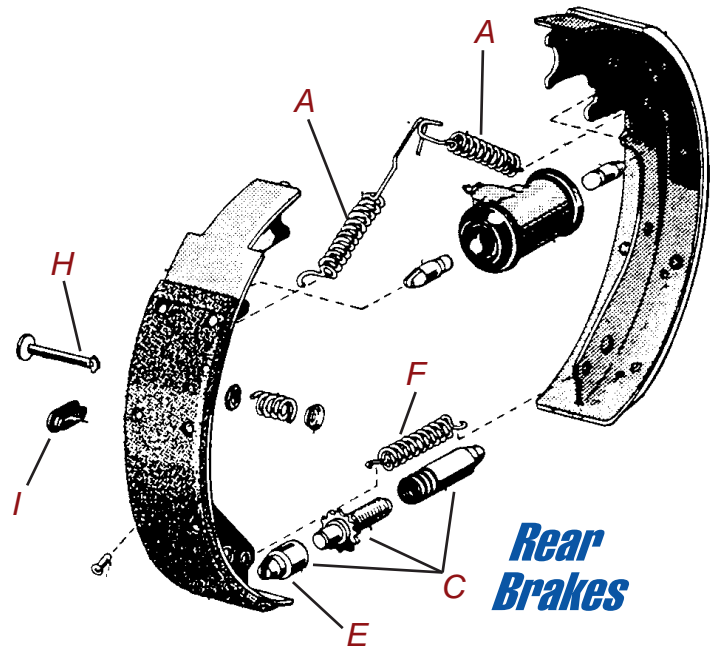

BRAKE ADJUSTING HOLE COVER

Part #	8A-2092	
Type	Rubber	
Year	1949-59	
Price	0.75 ea.	



Wheel Cylinder ASSEMBLY

(Front)

(Rear)

PART #	SIDE	POSITION	SIZE I.D.	FITS	YEAR	PRICE
AD-2061-D	RH	FRONT	1 1/8"	Passenger	49-56	19.95 ea.
AD-2062-D	LH	FRONT	1 1/8"	Passenger	49-56	19.95 ea.
8A-2261	RH	REAR	7/8"	All except Wagon	49-59	19.95 ea.
8A-2262	LH	REAR	7/8"	All except Wagon	49-59	19.95 ea.
B7A-2061	RH	FRONT	1 1/8"	Passenger	57	29.95 ea.
B7A-2061	LH	FRONT	1 1/8"	Passenger	58	29.95 ea.
B7A-2061	RH	FRONT	1 1/8"	Passenger	59	29.95 ea.
B7A-2062	LH	FRONT	1 1/8"	Passenger	57	29.95 ea.
B7A-2062	RH	FRONT	1 1/8"	Passenger	58	29.95 ea.
B7A-2062	LH	FRONT	1 1/8"	Passenger	59	29.95 ea.

BRAKE HOSES

PART #	PIC	DESCRIPTION	FIT	YEAR	PRICE
FRONT Brake Hoses					
8A-2079	J	Front	All	49-53	12.95 ea.
AD-2079-B	K	Front	All	54-56	14.95 ea.
B7A-2079	L	Front	All	57	14.95 ea.
B8A-2079	M	Front	All	58	14.95 ea.
B9A-2079	N	Front	All	59	14.95 ea.
REAR Brake Hoses					
AB-2078-C	O	Rear	All	52-56	14.95 ea.
8A-2078	P	Rear	All ex. Wagon & Skyliner	57-58	12.95 ea.
C1TT-2282		Rear	Wagon Only	57-58	14.95 ea.
B7A-2079	L	Rear	Skyliner Only	57	14.95 ea.
B8A-2079	M	Rear	Skyliner Only	58	14.95 ea.
B8A-2079		Rear	All	59-64	14.95 ea.
Brake HOSE CLIP					
8M-2814	Q	Hose Clip	Need (3)	54-59	1.95 ea.

Wheel Cylinder REPAIR KIT (each kit does (1) wheel)

PART #	DESCRIPTION	YEAR	PRICE
FRONT Wheel			
8M-2221	1 1/8" - All	49-59	7.95 ea.
REAR Wheel			
8A-2128	7/8" - All Except Wagon	49-59	7.95 ea.
B2A-2128	15/16" - Wagon Only	49-59	7.95 ea.







Wheel Cylinder to Brake Shoe Pin

Part #	B7A-2042-A
Note	Need 2 or 4
Year	1957-75
Price	1.95 ea.



Brake Pedal PADS

PART #	PIC	DESCRIPTION	AUTOMATIC Transmission	MANUAL Transmission	MANUAL Brakes	FITS	YEAR	PRICE
AB-2454-B		<u>Brake Pedal Pad Assembly</u> High quality molded rubber pad with metal backing.	<input checked="" type="checkbox"/>	<input checked="" type="checkbox"/>	<input checked="" type="checkbox"/>	All	52-59	20.95 ea.
B9A-2454-B		<u>"SwiftSure" Power Brake Pedal</u> High quality molded rubber pad with Chrome Trim & metal backing. "SWIFT SURE" embossed on Chrome.	<input checked="" type="checkbox"/>	<input checked="" type="checkbox"/>	<input checked="" type="checkbox"/>	All	54-59	73.95 ea.
B7A-2457-A		<u>Brake (or Clutch) Pedal Pad</u> - Original - Stright Drive	<input checked="" type="checkbox"/>	<input checked="" type="checkbox"/>	<input checked="" type="checkbox"/>	All	52-59	4.50 ea.
AB-2454		<u>Brake (or Clutch) Pedal Pad</u> - Replacement - Stright Drive					52-59	5.95 ea.

Brake Pedal BUSHINGS

Made of Plastic

PART #	PIC	DESCRIPTION	YEAR	PRICE
B7AZ-2471-A	A	<u>Brake (or Clutch) Pedal Bushing</u>	60-72	0.95 ea.
B5A-2481-A	B	<u>Brake Pedal Spring Insulator / Bushing</u>	Mercury 55-61	34.95 ea.

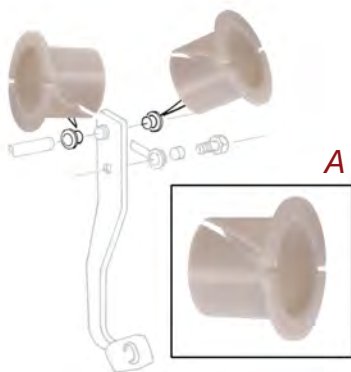

- 5/8" long - Need (2) per pedal



Brake Pedal ARM BUMPER

PART #	YEAR	PRICE
*MA-7583-A	52-59	1.95 ea.



Park Brake EQUALIZER ROD

PART #	PIC	DESCRIPTION	YEAR	PRICE
B7A-2628-B		<u>Park Brake Equalizer Rod</u> - Universal - 12" Long - cut from thread end to required length	52-59	9.95 ea.

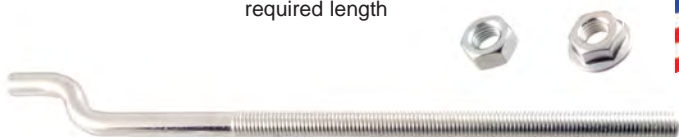

50,000 PART NUMBERS IN STOCK!

SHOP ONLINE

www.dennis-carpenter.com

PARK BRAKE CABLE ASSEMBLY

PART #	PIC	DESCRIPTION	LENGTH	FITS	YEAR	PRICE
B5A-2853-C		FRONT	58 1/2" long	Convertible	55-56	44.95 ea.
B5A-2853-D	G	FRONT	52 1/2" long	All except Convertible	52-56	34.95 ea.
B7A-2853-A	H	FRONT	44 1/4" long	All	57-58	44.95 ea.
B7AZ-2A635-A	I	REAR	80 1/2" long	Fits all except Retractable & Convertible	57-59	44.95 ea.

**Park Brake
CLIPS, SPRINGS, PADS AND NUTS**

PART #	PIC	DESCRIPTION	YEAR	PRICE
Park Brake CLIPS & SPRING				
*91A-2106	C	Arm to Brake Shoe Clip - (2) per car	39-59	0.95 ea.
OM-2788	D	Ratchet Bar Pawl Locking Spring	52-58 60-64	3.95 ea.



Park Brake PEDAL PAD

B9A-2454-A	E		59	7.95 ea.
------------	---	--	----	----------



Park Brake Cable ADJUSTING NUT

*8A-2091	F	- Ford.....	49-64	5.95 ea.
----------	---	-------------	-------	----------



G



H



• (2) per car

I

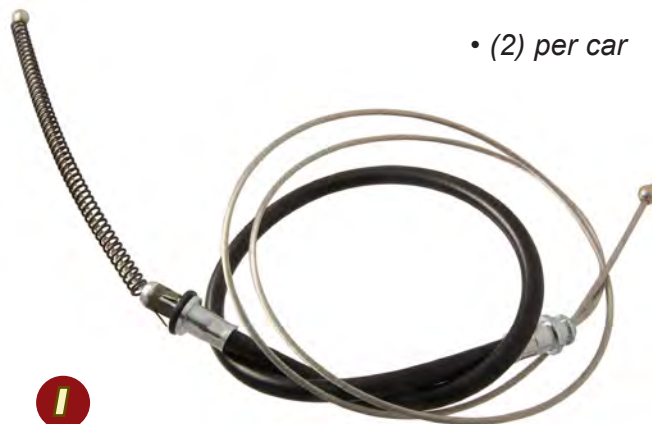

\$9.99
or
\$14.99

**FLAT RATE
SHIPPING**
See shipping page for details.

**FRONT SUSPENSION
RUBBER BUMPERS**

PART #	PIC	TYPE	SIDE	NOTE	YEAR	PRICE
8A-3025	A	Upper Bumper	RH or LH		49-53	2.95 ea.
B4AZ-3020	B	Upper Bumper	RH or LH		54-56	5.95 ea.
C0AZ-3020-A	C	Upper Bumper		Fits Passenger	57-63	7.50 ea.
AB-3019-A	D	Lower Bumper	RH or LH		49-52	5.95 ea.
B5A-3019-A	E	Lower Bumper	RH		54-56	9.95 ea.
B5A-3020-A	F	Lower Bumper	LH		54-56	9.95 ea.
B7A-3019	G	Lower Bumper	RH or LH	- without Stud	57	6.95 ea.
B8A-3019-A	H	Lower Bumper	RH or LH	- with Stud	57-63	6.95 ea.

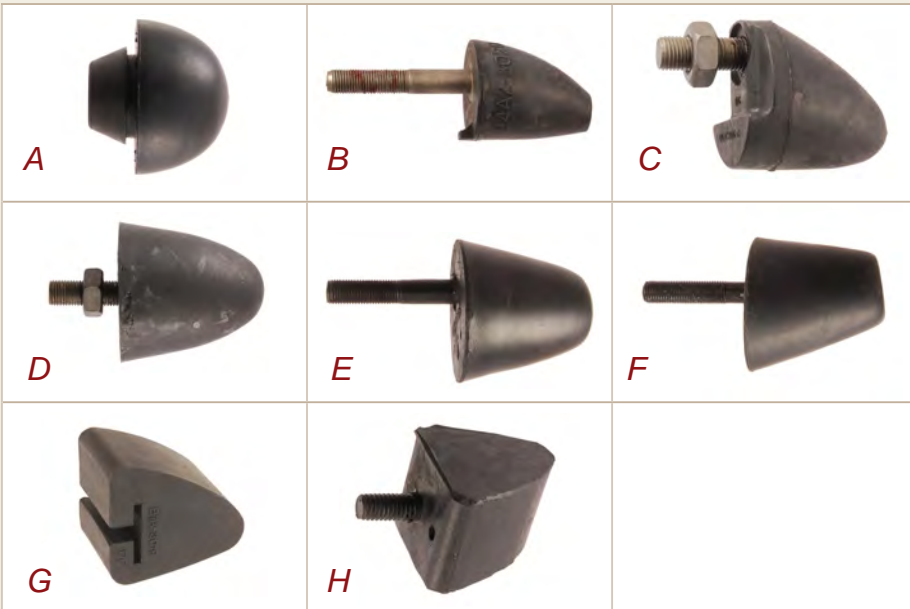

CONTROL ARM BUSHINGS

PART #	PIC	DESCRIPTION	YEAR	PRICE
LA-3068	M	Upper Inner Front	1 per side	54-56 6.95 ea.
B4A-3087	N	Upper Inner Rear	1 per side	54-56 6.95 ea.
B4A-3069	O	Lower Inner	2 per side	54-59 7.95 ea.
AJ-3068-A	P	Upper Inner	2 per side	57 11.95 ea.



**BALL JOINTS
(need 2 per car)**

PART #	PIC	DESCRIPTION	YEAR	PRICE
B5A-3049-A	I	Upper	54-56	49.95 ea.
B5A-3050-A	J	Lower	54-56	49.95 ea.
C1AZ-3049	K	Upper	57-64	24.95 ea.
C1AZ-3050	L	Lower	57-64	49.95 ea.





**Did you know there is a National Club
for Early Ford V-8 enthusiasts?**

Why not become a member?

Founded in San Leandro, California in 1963, the Early Ford V-8 Club of America recognizes all 1932-1953

Ford Motor Company vehicles including Ford, Lincoln, Mercury, Commercial vehicles, tractors, as well as other Ford powered vehicles built around the world including the 4, 6, 8, and 12-cylinder engines built by the Ford Motor Company.

Today, as the premier marquee club of our represented vehicles with a world-wide membership of over 11,000 and 125 active regional groups, we are dedicated to the restoration and preservation of all 1932 through 1953 Ford Motor Company vehicles.

The club's award winning bi-monthly magazine, the V-8 TIMES, is circulated all over the world and is acclaimed as one of the best car club magazine anywhere.

The V-8 TIMES features technical articles, shop tips, questions and answers to help with your restoration from a panel of experts, nostalgic and historical articles, club and regional



**Celebrating 1932-1953
Ford Vehicles**

group news, offerings of accessories and restoration manuals found nowhere else - plus classified ads on cars and parts.

Traditionally, the Early Ford V-8 Club of America has three National Meets hosted by regional group(s) in the eastern, central and western United States. These provide an excellent opportunity to see some great cars and network with those sharing your love of the 1932-1953 Fords.

Every five years, a Grand National Meet is held. Dearborn, the home of the Ford Motor Company, is usually the site of this meet. In 2008, the 45th Anniversary Meet was held there.

You'll find the most up-to-date information on the club and activities on the club's website. You can also participate in Forums and ask for help with your restorations.

You can also visit our online store for a variety of items including the club's outstanding restoration books highlighting certain model years.



MEMBERSHIP BENEFITS

- V-8 TIMES Magazine
- Annual Membership Roster
- National Meets & Tours



Early Ford V-8 Club of America

P.O. Box 1715 Maple Grove, MN 55311

Membership

Toll Free: 866-427-7583

763-420-7829

E-Mail: registration@cornerstonereg.com



www.efv8.org



FRONT SUSPENSION SEALS

(needs 4 per car)

PART #	PIC	DESCRIPTION	TYPE	YEAR	PRICE
8M-3074	A	Lower Suspension Shaft Seal	Inner	49-53	2.95 ea.
8A-3075	B	Upper Suspension Shaft Seal	Outer	49-53	2.95 ea.
8M-3076	C	Upper Suspension Shaft Seal	Inner	49-53	2.95 ea.
8A-3088-B	D	Lower Suspension Pivot Shaft Seal	Inner	49-53	2.95 ea.



FRONT COIL SPRING INSULATOR

Part #	8A-5415-A
Type	Rubber
Year	1949-72
Price	4.95 ea.

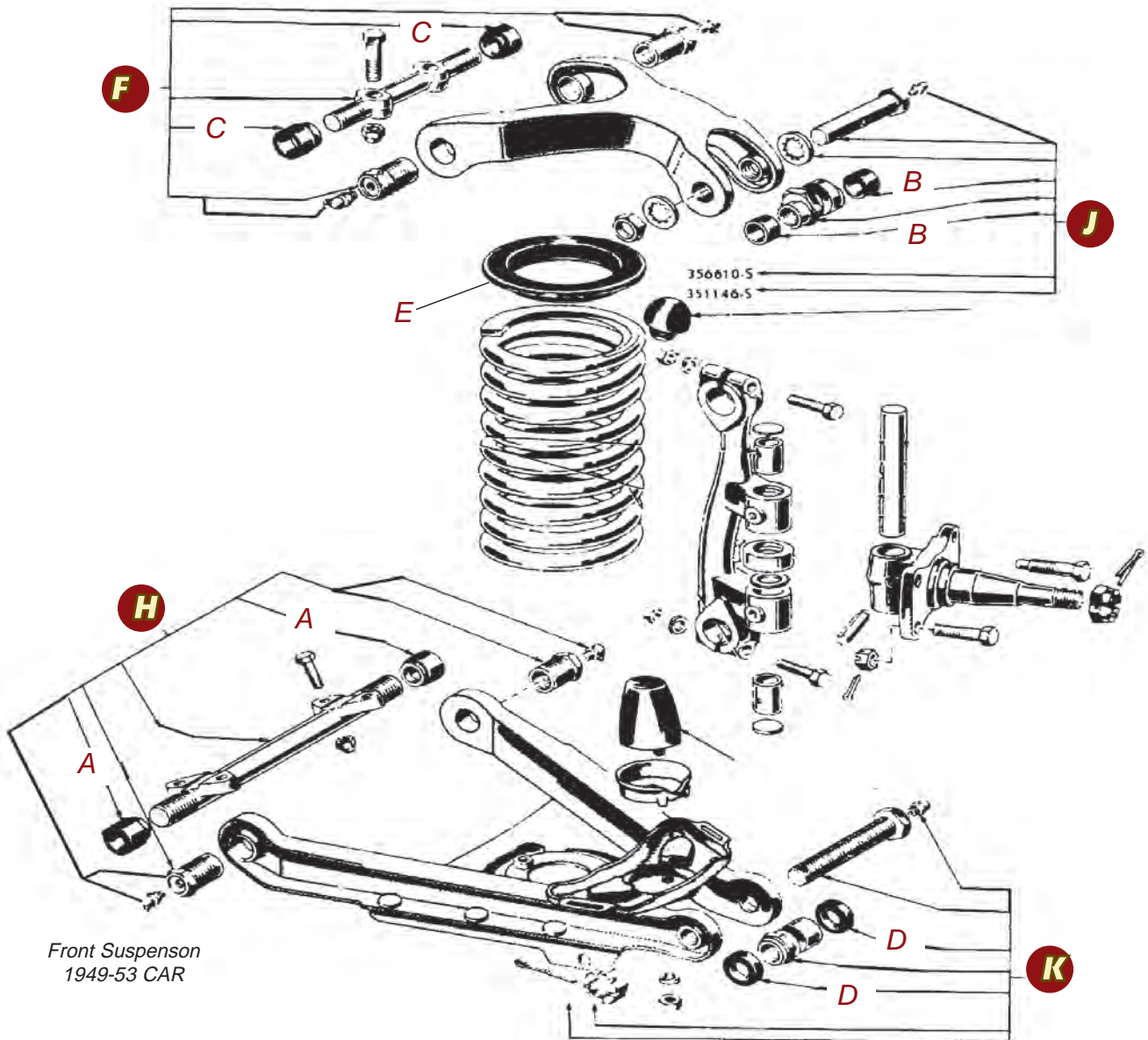

Front Suspension
1949-53 CAR



FRONT SUSPENSION SHAFT KITS

(each kit does (1) side only)

PART #	PIC	TYPE	POSITION	YEAR	PRICE
8A-3047	F	Upper	Inner	49-53	39.95 ea.
*B4A-3047-B	G	Upper	Inner	54-56	29.95 ea.
8A-3048	H	Lower	Inner	49-53	39.95 ea.
B6A-3048	I	Lower	Inner	54-56	29.95 ea.



F



G



H



I

FRONT SUSPENSION SUPPORT PIVOT KITS

Each kit does (1) side only

PART #	PIC	TYPE	YEAR	PRICE
8A-3049	J	Upper	49-53	34.95 ea.
8A-3050	K	Lower	49-53	26.95 ea.



J



K

KING PIN BOLT KIT

(each kit does both sides)

PART #	DESCRIPTION	YEAR	PRICE
A9A-3111-A	Spindle Bolt & Bushing Kit	49-53 52-53 Merc.	59.95 kit



**50,000
PART NUMBERS
IN STOCK!**



www.dennis-carpenter.com



IDLER ARM KITS

PART #	PIC	DESCRIPTION	YEAR	PRICE
*B2A-3352-A	A	- w/o Power Steering	52-53	39.95 kit
B4A-3352-A	B	- w/ Power Steering	54-59	39.95 kit
B5A-3352		- w/o Power Steering	54-56	39.95 kit
B7A-3352		- w/o Power Steering	57-59	29.95 kit

IDLER ARM PARTS

PART #	PIC	DESCRIPTION	NOTE	YEAR	PRICE
8A-3351	C	Bracket	w/o Power Steering	49-59	24.95 ea.
*8M-3359	D	Seal		49-59	2.95 ea.
MB-3356-A	E	Bushing	w/o Power Steering	49-59	4.95 ea.

C



D



Included in Kit

E



Included in Kit

50,000
PART NUMBERS
IN STOCK!
SHOP ONLINE
www.dennis-carpenter.com

SPINDLE ARM

PART #	PIC	DESCRIPTION	YEAR	PRICE
AB-3130-A	F	RH	52-53	50.00 ea.
AB-3131-A	G	LH	52-53	50.00 ea.

F



G

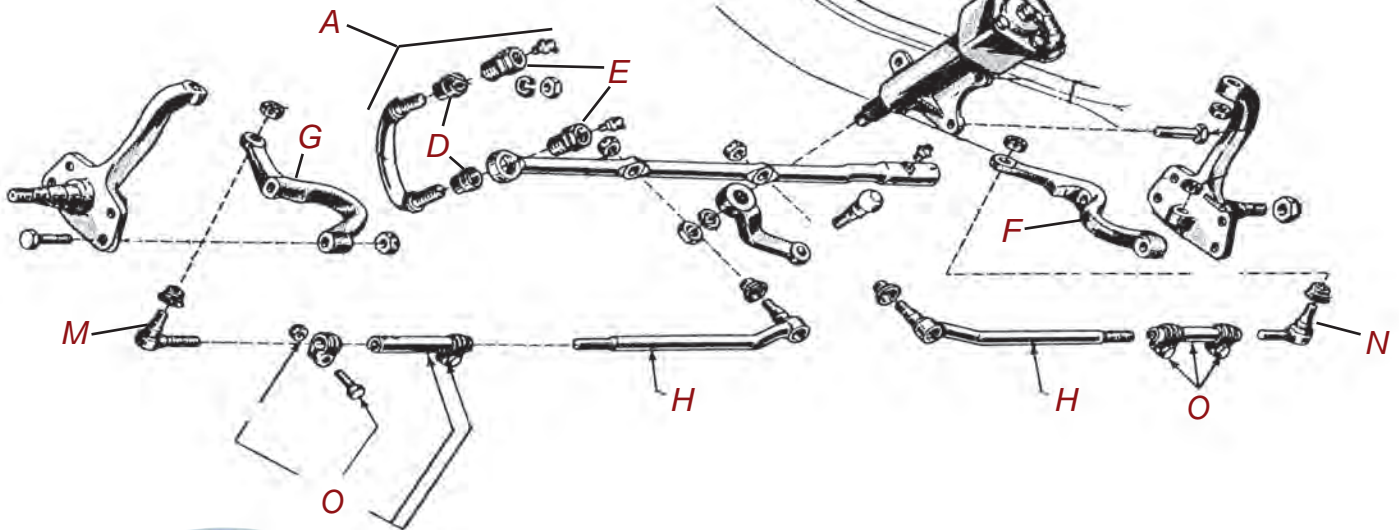

**TIE ROD ENDS
INNER**

PART #	PIC	TYPE	YEAR	PRICE
AB-3280-A	H	LH or RH	52-53	49.95 ea.
AD-3280-B	I	LH or RH	54-56	39.95 ea.
B7A-3280	J	RH	57-58	44.95 ea.
B7A-3281	K	LH	57-58	44.95 ea.
MB-3280-A	L	LH or RH	Mercury 54-56	39.95 ea.



H



I



J



K



L

**TIE ROD ENDS
OUTER**

(includes Grease Fittings & Seals)

PART #	PIC	DESCRIPTION	NOTE	YEAR	PRICE
11A-3290	M	LH Threads	(2) per car	49-53	14.95 ea.
11A-3289	N	RH Threads	(2) per car	54-59	14.95 ea.



M



N

TIE ROD ARM SLEEVE

PART #	PIC	DESCRIPTION	YEAR	PRICE
11A-3310	O		41-59	12.95 ea.

O

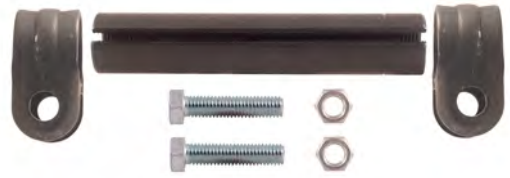

**TIE ROD END
SEALS**

Part #	48-3332
Note	Set of (4)
Year	1935-56
Price	5.95 set



**DRAG LINK TO PITTMAN ARM
BALL STUD REPAIR KIT**

PART #	PIC	DESCRIPTION	YEAR	PRICE
B2AZ-3533-A	P	Passenger w/o Power Steering	49-59	59.95 ea.
B3AZ-3533-A	Q	Used with Power Steering	53-56	39.95 ea.

P



Q



STABILIZER TO FRAME BUSHINGS

PART #	PIC	DESCRIPTION	NOTE	YEAR	PRICE
*AB-5493-B	A	All ex. Wagons	Need (4) per car	52-53	4.95 ea.
B5A-5493	B	All	Sold as pair.	54-56	7.95 pr.
B7A-5493-A	C	ALL ex. Sedan Delivery, Wagon, Retractable, & Ranchero	Set of (4)	57-58	29.95 set
B7A-5493-B	D	Sedan Delivery, Wagon, Retractable, & Ranchero	Set of (4)	57-58	29.95 set
B9A-5493-A	E	ALL ex. Wagon, Retractable, & Ranchero	Sold as pair.	59	14.95 pr.
B9A-5493-B	F	Wagon, Retractable, & Ranchero	Sold as pair.	59	14.95 pr.

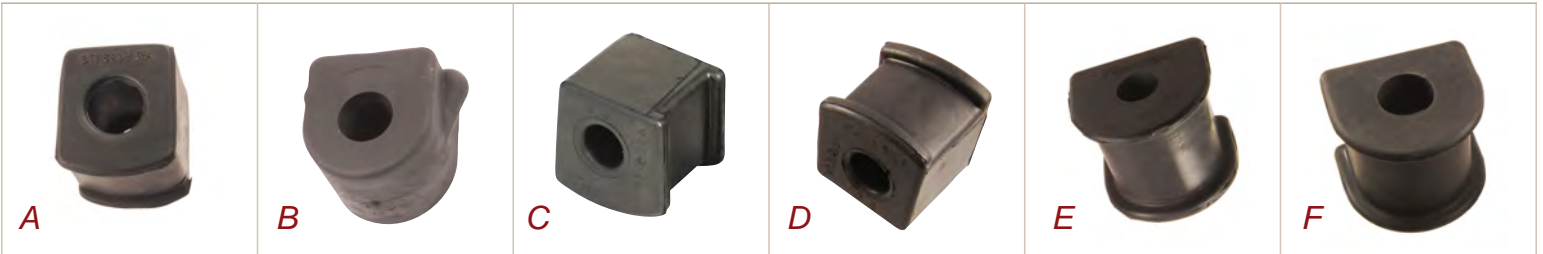

FRONT STABILIZER BAR BUSHING & BRACKET KIT

PART #	PIC	FITS	YEAR	PRICE
Includes: 2 each of #5492 Outer Bracket & 5476 Inner Bracket, 4 each of #5493 Frame Bushings & attaching parts				
B7A-5475-AK	G	Fits ALL Ex. Wagon, Sedan Delivery, Retractable & Ranchero	57-58	89.95 kit
B7A-5475-BK	H	Fits Wagon, Sedan Delivery, Retractable and Ranchero	57-58	94.95 kit

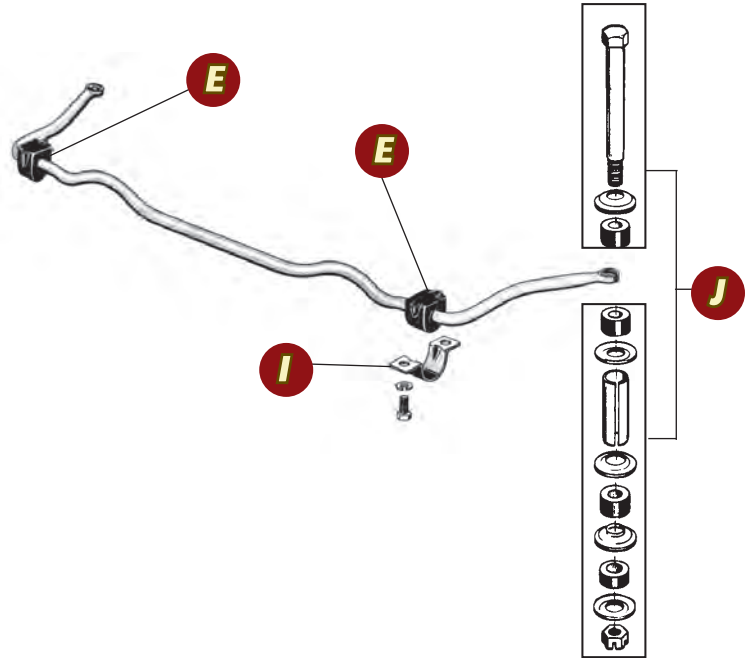

FRONT STABILIZER BAR CLAMP

Part #	8M-5486
Type	Need 2 per car
Year	1954-56
Price	11.95 ea.



STABILIZER BAR END REPAIR KIT

Part #	B4AZ-5A486-A
Type	Passenger
Note	Need (2) kits per car
Year	1954-56
Price	16.50 kit



POWER STEERING RELATED KITS

PART #	PIC	DESCRIPTION	YEAR	PRICE
B5AZ-3A764-A	K	Power Steering Cylinder Repair Kit	55-56	23.95 ea.
C1AZ-3A764-A	L	Power Steering Cylinder Repair Kit	57-64	14.95 ea.
C2SZ-3B584-A	M	Power Steering Pump Repair Kit	57-59	14.95 ea.

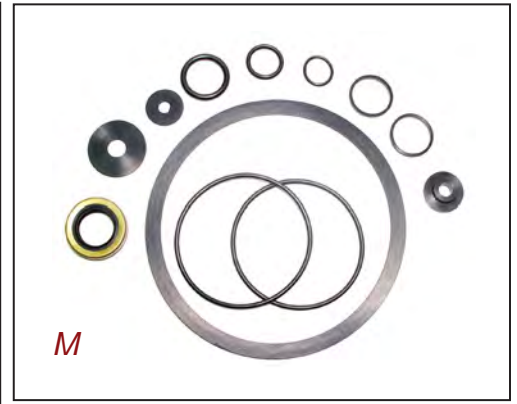

POWER STEERING PARTS

PART #	PIC	DESCRIPTION	NOTE	YEAR	PRICE
B-7600	N	Power Steering Pump Rotor Shaft Bearing		1953-56	5.95 ea.
*B5AZ-3A717-A	O	Power Steering Hose from Control Valve to Cylinder	(2) per car	Mercury 1954-56	29.95 ea.
B7A-3A714-A	P	Power Steering Hose from Control Valve to Cylinder	(2) per car	1957-59	39.95 ea.
B4AZ-3A719-B	Q	Power Steering Hose Pump to Valve	6 cylinder	1954-55	37.95 ea.
B7AZ-3A719-A	R	Power Steering Hose Pump to Valve	6 & 8 cylinder	1956-58	47.95 ea.
B8AZ-3A719-B		Power Steering Hose Pump to Valve	8 cylinder	1959	45.95 ea.
B7A-33538-B	S	Power Steering Oil Reservoir Filter Element	6 or 8 cylinder	1957-59	27.95 ea.

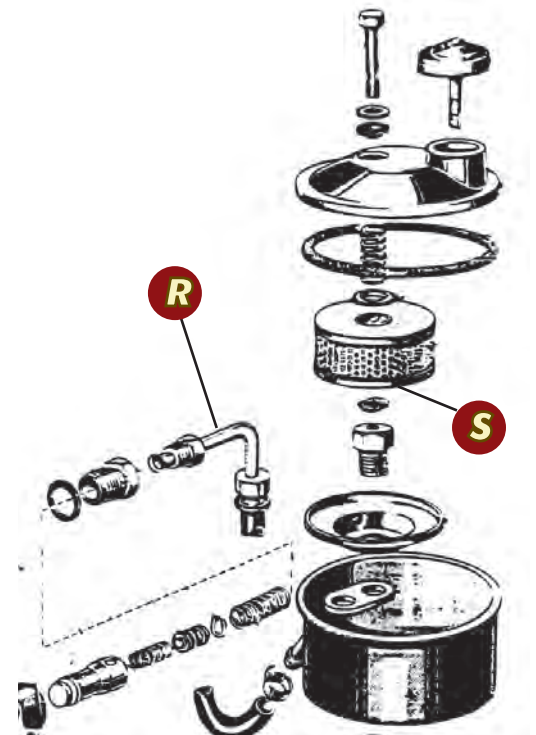

STEERING GEAR PARTS

PART #	PIC	DESCRIPTION	NOTE	YEAR	PRICE
51A-3517-A	A1	Steering Column Upper Shaft Bushing		49-53	5.95 ea.
B1AZ-3518-A	A	Steering Column Upper Bearing Sleeve	Plastic	54-59	9.95 ea.
8M-3520	B	Steering Column Upper Bearing Spring	Mercury Only	49-52	3.95 ea.
8A-3591-A	C	Steering Sector Seal		49-64	4.95 ea.
8M-3591	D	Steering Sector Seal	Use w/ 3 teeth sector	56-57	4.95 ea.
B-3552	E	Steering Worm Cup	Lower	49-57	10.95 ea.
8A-3553	F	Steering Worm Cup	Upper	49-57	29.95 ea.
68-3571-A	G	Steering Worm Roller Bearing	(2) per car	49-57	9.95 ea.
68-3576	H	Steering Sector Shaft Bearing	(2) per car	49-55	11.95 ea.



STEERING COLUMN BRACKET INSULATOR

PART #	PIC	DESCRIPTION	YEAR	PRICE
B5A-3683-A	I	Steering Column Bracket to Dash Insulator	55	7.95 ea.
B6A-3683-A	J	Steering Column Bracket to Dash Insulator	56	7.95 ea.
B7A-3683-A	K	Steering Column Bracket Cover to Dash Insulator	57-58	7.95 ea.



STEERING COLUMN TO FLOOR SEALS

PART #	PIC	DESCRIPTION	YEAR	PRICE
BA-3513-C	P	Goes under floor mat	52-54	9.95 ea.
B5A-3513	Q	Goes under floor mat	55-56	9.95 ea.
B7A-3513	R	Goes under floor mat	57-58	9.95 ea.
11A-7001730	S	Goes on top of floor mat	41-58	9.95 ea.

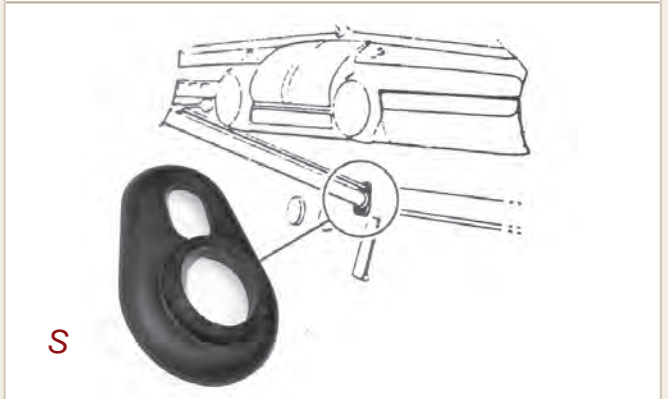

STEERING WORM & SHAFT NEW OLD STOCK

PART #	PIC	LENGTH	TEETH	YEAR	PRICE
AD-3524-A	L	41 5/8" long	4 teeth sector	54	200.00 ea.
B6A-3524-B		37 13/32" long	2 teeth sector	56	99.95 ea.
B8A-3524-A	M	40 1/2" long	4 teeth sector	58-59	200.00 ea.

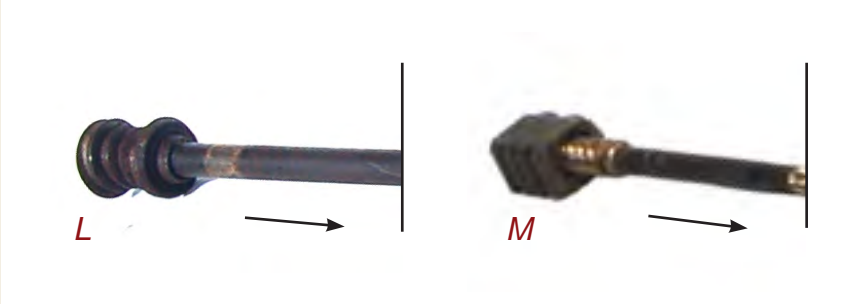

STEERING BOX GASKETS

PART #	PIC	DESCRIPTION	YEAR	PRICE
AB-3581	N	Steering Box Gasket Set	52-57	7.50 set
B8A-3581-A	O	Steering Housing Cover Gasket - Passenger	58-59	2.95 ea.



HORN RINGS

Customline & Fairlane

PART #	PIC	DESCRIPTION	YEAR	PRICE
B5A-13A805-A	A	- w/o power steering	55	174.95 ea.
B5A-13A805-B	B	- with power steering	55	194.95 ea.



HORN BUTTON EMBLEMS

Horn Button - FORD CREST

Made in USA

PART #	PIC	DESCRIPTION	YEAR	PRICE
FAD-3627	C	- 50th Anniversary	53	34.95 ea.
B5A-3627	D	- Plastic	55	34.95 ea.
B6A-3627	E	- Clear Plastic	56	34.95 ea.
B7A-3627	F	- Plastic	57	34.95 ea.

Horn Button - FOR POWER STEERING

For Mercury Only

PART #	PIC	DESCRIPTION	YEAR	PRICE
FDK-3623-F	G	- Red Background	55	74.95 ea.
FDT-3623-B	H	- White Background	56	74.95 ea.



HORN BUTTON PARTS

Part #	FAD-3626-A
Type	Horn Button Spring
Year	1952-59
Price	3.95 ea.



Part #	B5A-3672-A
Type	Horn Button Insulator
Note	- Rubber
Year	1955-56
Price	1.95 ea.



Part #	B5A-3672-B
Type	Horn Button Emblem Pad
Year	1955-56
Price	2.95 ea.



HORN PLATE BUTTON INDEX

Part #	B9AZ-13A809-A
Note	Plastic piece that goes under horn ring
Fits	All except Customs & Ranch Wagons
Year	1959
Price	5.95 ea.



**STEERING/WHEEL / HORN RING
FINISH "ENDS"**

PART #	PIC	DESCRIPTION	YEAR	PRICE
B5A-3650-PR		Steering Wheel/Horn Ring Finish "Ends"	55	24.95 ea.

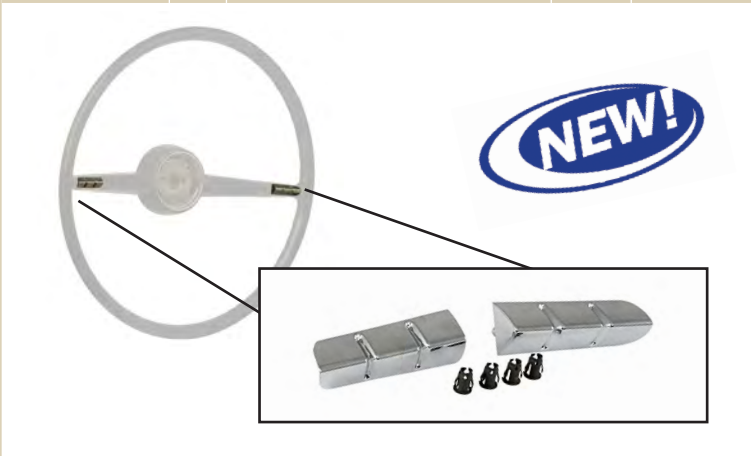

HORN WIRING

PART #	PIC	DESCRIPTION	YEAR	PRICE
Horn Wiring for Steering Column				
1A-14308-B	M	All	51-56	12.50 ea.
B7A-14308		All	57-58	16.95 ea.
B9A-14308		All	59-62	9.95 ea.

Horn to Relay Wire

B7A-14440-A	N	77 1/4" long	57	17.95 ea.
-------------	---	--------------	----	-----------



HORN ASSEMBLY

Can be used on 1954-55 if vehicle has been converted to 12 volt

Part #	B7A-13832-A
Type	Horn Assembly
Note	High Pitch
Year	1954-64
Price	39.95 ea.



Part #	B7A-13832-B
Type	Horn Assembly
Note	Low Pitch
Year	1954-64
Price	39.95 ea.



KEY BLANKS

Official Ford Licensed

Part #:	BA-3685-A	
Type:	Ignition	
Year:	1952-64	
Price:	2.50 ea.	
Part #:	BA-3685-B	
Type:	Trunk Lid	
Year:	1952-64	
Price:	2.50 ea.	
Part #:	BA-3685-ANV	
Type:	Anniversary (Ignition only)	
Year:	1952-64	
Price:	10.00 ea.	

"FORD" KEY CHAINS

PART #	PIC	DESCRIPTION	PRICE
KC-1	O	Ford Keychain - Metal	4.95 ea.
KC-2	P	Blue w/ Address slip you call fill out - Plastic	4.95 ea.
KC-3	Q	Red w/ Address slip you can fill out - Plastic	4.95 ea.

HORN RELAY

PART #	PIC	DESCRIPTION	YEAR	PRICE
7RA-13853	I	3 screw terminals	49-55	15.95 ea.
B6A-13853	J	3 screw terminals	56	17.95 ea.
B8A-13853	K	3 spade terminals	57-63	16.95 ea.



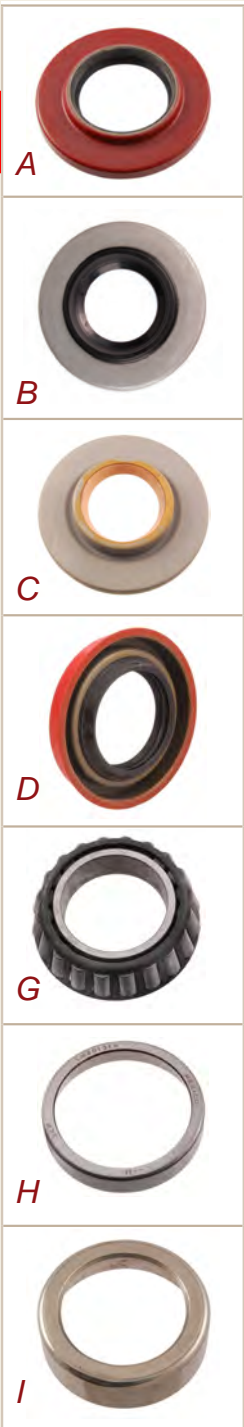

DRIVE PINION SEAL

PART #	PIC	DESCRIPTION	SIZE	YEAR	PRICE
8A-4676	A	All Except Wagon & Sedan Delivery	1 11/16" I.D. x 3" O.D.	49-56	12.50 ea.
B6A-4676-A	B	Station Wagon & Sedan Delivery	1 9/16" I.D. x 3 5/32" O.D.	49-56	7.95 ea.
B7A-4676-A	C		1 13/16" I.D. x 4 1/8"	57	14.95 ea.
B8A-4676-B	D	All	2 1/8" x 3" O.D.	58-59	11.95 ea.

REAR AXLE PARTS

PART #	PIC	DESCRIPTION	YEAR	PRICE
8A-4035-C	E	Rear Axle Carrier Gasket	49-56	5.95 ea.
B7A-4035	F	Rear Axle Carrier Gasket	57-60	6.95 ea.
B7A-4221-A	G	Rear End Carrier Bearing - For Differential w/ Medium Carrier Bearings	57-59	6.95 ea.
B7A-4222-A	H	Rear End Carrier Bearing Race	57-59	5.95 ea.
B5A-4616-B	I	Front Pinion Bearing Race	55-56	4.95 ea.
8A-4621	J	Front Pinion Bearing	49-54	44.95 ea.
B5A-4621-B	K	Front Pinion Bearing	49-54	44.95 ea.
8A-4663	L	Drive Pinion Bearing Shims	49-55	9.95 set

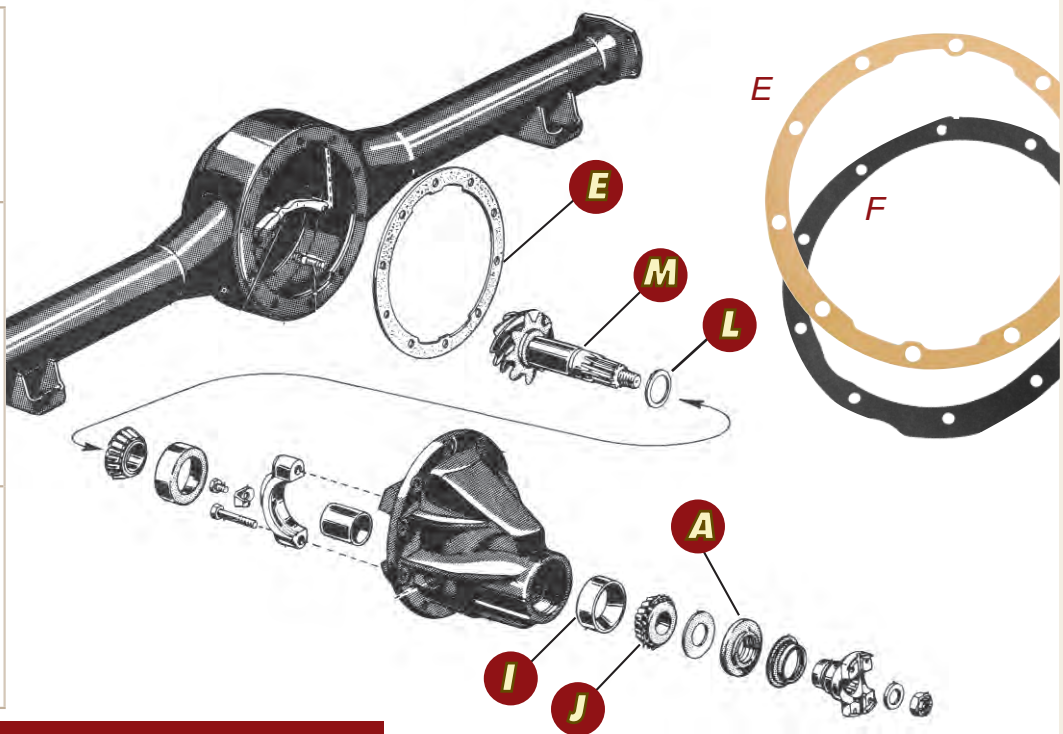

REAR END RING GEAR & PINION SET

Part #	B8AZ-4209-C
Type	- 9" Ring Gear
Note	- 3.25 Ratio
Year	57-72
Price	299.95 set

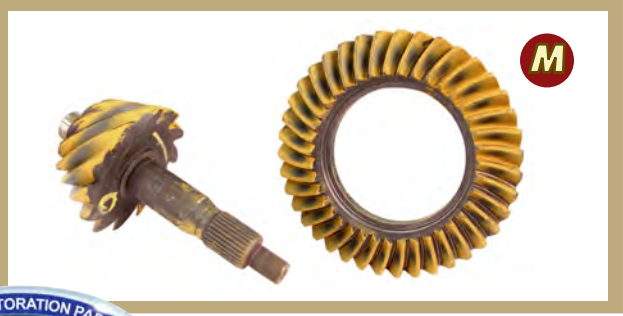

Rear Axle BUMPERS

Part #	B6A-5783-A
Type	Rear Axle Bumper
Note	Rubber bonded to metal
Fits	Retractable only
Year	1957-58
Price	11.95 ea.



Part #	B7A-5783
Type	Rear Axle Bumper
Note	Need (5) per car 1 in the center & 2 on each side
Year	1957-59
Price	4.95 ea.



Rear Axle GASKETS

S

Part #	8A-2245
Type	Rear Wheel Bearing Retainer Gasket
Year	1949-56
Price	2.95 ea.



Part #	8A-2256
Type	Backing Plate to Rear Axle Housing Gasket
Year	1949-56
Price	2.95 ea.

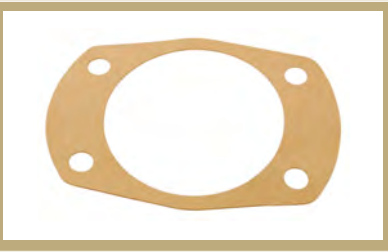

REAR AXLE BEARINGS & SEALS

PART #	PIC	DESCRIPTION	FITS	YEAR	PRICE
Rear Axle GREASE SEALS					
8A-1177-A	N	1-3/8" I.D. X 2 1/2" O.D.	All Except Sedan Delivery & Station Wagon	49-56	4.95 ea.
B7A-1177-A	O	1-1/2" I.D. X 2-1/2" O.D.	Sedan Delivery, Retractable, Ranchero, Station Wagon	49-59	4.95 ea.
B7A-1177-B	P	1 3/8" ID - 2 3/8 OD	All Passenger Ex. Sedan Delivery Station Wagon Retractable & Ranchero	57-58	5.95 ea.
B7A-1177-B	P	1 3/8" ID - 2 3/8 OD	All Passenger except Heavy Duty Wagon, Retractable & Ranchero	59	5.95 ea.

Rear Axle BEARINGS

8A-1225-A	Q	Rear Axle Bearing		49-56	29.95 ea.
B7AZ-1225	R	Rear Axle Bearing		57-60	29.95 ea.

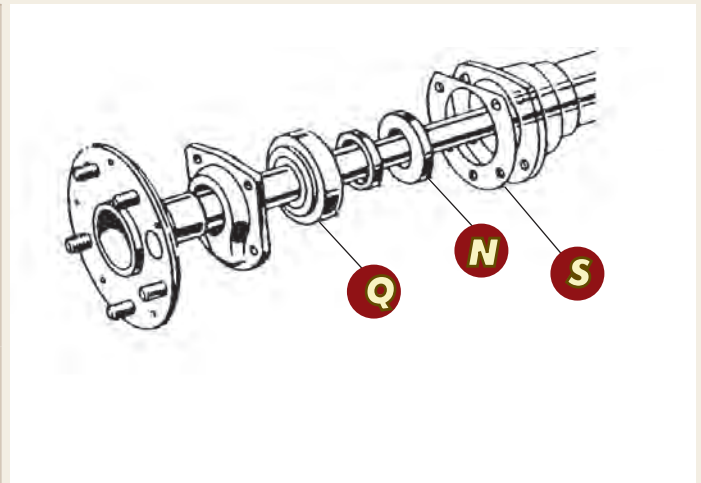

50,000 PART NUMBERS IN STOCK!

SHOP ONLINE

www.dennis-carpenter.com

REAR SPRING PARTS

PART #	PIC	DESCRIPTION	TYPE	NEED	FIT OR TYPE	YEAR	PRICE
Rear Spring ANTI-SQUEAK PAD Between Spring Leaves							
B8A-5586-A	A	Anti-Squeak Pad	Rear Spring	Need (12) per car	Passenger Car	52-53	0.95 ea.
B8A-5586-A	A	Anti-Squeak Pad	Rear Spring	Need (12) per car	Passenger Car	57-59	0.95 ea.
B8A-5586-A	A	Anti-Squeak Pad	Rear Spring	Need (16) per car	Passenger Car	54-56	0.95 ea.
B8A-5586-A	A	Anti-Squeak Pad	Rear Spring	Need (16) per car	Sedan Delivery & Wagon	52-59	0.95 ea.

Rear Spring RUBBER BUSHING

B5A-5781-C	G	Bushing	Front of Rear Spring			55-56	6.95 ea.
*8A-5719	B	Bushing	Rear Spring	Need (6) per spring	Rubber	49-54	1.95 ea.
*8A-5719	B	Bushing	Rear Spring	Need (4) per spring	Rubber	55-59	1.95 ea.

Rear Spring LINER, PAD, & U-BOLT

8A-5334-S	C	Clamp Liner	Rear Spring	Set of (6)	Rubber	49-59	8.95 set
AB-5741-A	D	Upper & Lower Pad	Rear Spring	Need (4) per car		52-56	9.95 ea.
*MA-5705-F	E	U-Bolt	Rear Spring	Need (4) per car	Also fits 52-54 Mercury	49-56	6.95 ea.
B7A-5705-A	F	U-Bolt	Rear Spring	Need (4) per car		57-59	7.50 ea.

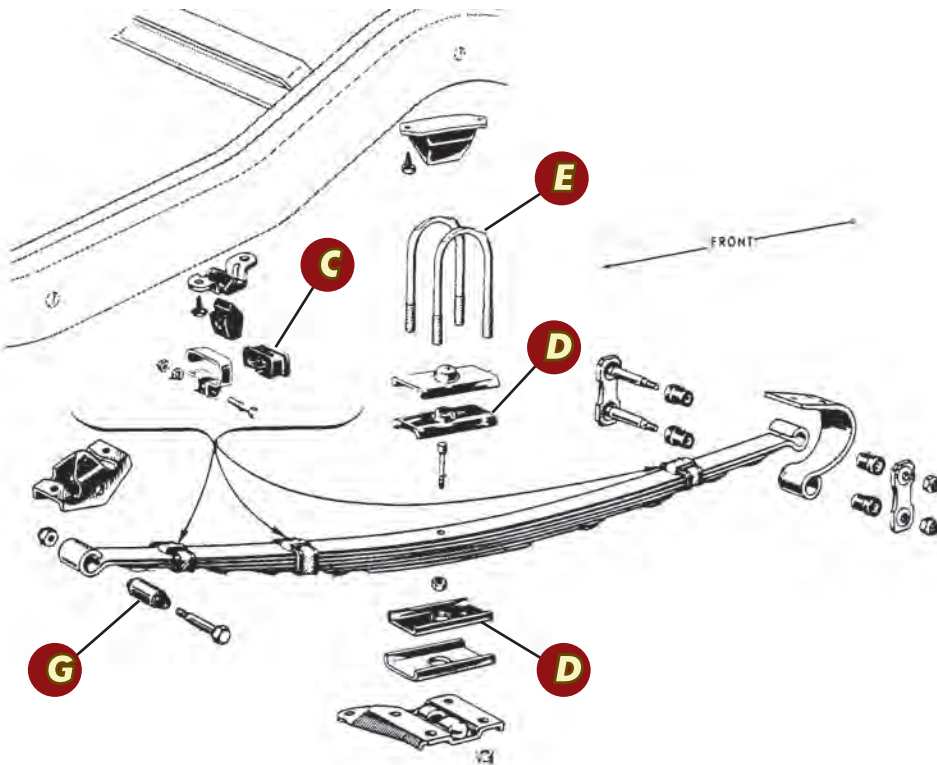

REAR SPRING SHACKLE KITS

Each Rear Spring Kit does one spring only.

PART #	PIC	DESCRIPTION	YEAR	PRICE
8A-5630	H	Front of Rear Spring Bolt & Bushings Kit	49-53	5.95 kit
B7A-5630-C	I	Front of Rear Spring Shackle Kit	57-59	14.95 kit
APA-5631	J	Rear of Rear Spring Shackle Bar Bolt & Bushing Kit	51-59	12.95 kit

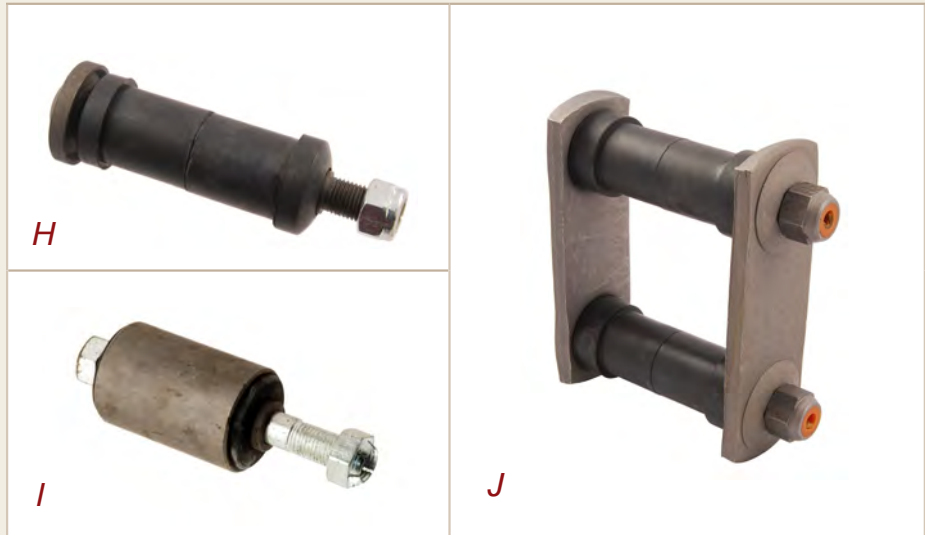

SHOCK ABSORBERS

PART #	PIC	DESCRIPTION	YEAR	PRICE
8A-18124	K	Front	52-56	59.95 ea.
B6C-18124	L	Rear	56	29.95 ea.
B7A-18124	M	Front	57-64	29.95 ea.



BODY TO FRAME PAD & BOLT KIT - 52-54

PART #	DESCRIPTION	YEAR	PRICE
BA-5001	2-door & 4-door sedan only	52-54	124.95 ea.

Each kit contains:

AMOUNT	PART
2	7/16"-14 x 2 3/8" studs
19	3/8"-16 x 2" bolts
15	3/8" lock washers
21	1 1/4" flat washers
23	square pads
2	7/16"-14 lock nuts
6	1 1/8" large flat washers
21	round pads
6	3/8"-16 lock nuts
2	horse shoe shims
2	3/8" -16 x 1 5/8" bolts
2	1 3/4" square metal washers
2	1" flat washers

12 7/16"-14 x 2 3/8" stud
square pad
1" flat washer
7/16"-14 lock nut

10 3/8"-16 x 2" bolt
1 1/2" flat washer
round pad
square pad
1 1/8" flat washer
3/8"-16 nut

8 3/8"-16 x 2" bolt
3/8" lock washer
1 1/4" lock washer
square pad
round pad
horse shoe shim

6 3/8"-16 x 1 5/8" bolt
3/8" lock washer
1 1/4" flat washer
round pad
square pad

4 3/8"-16 x 2" bolt
3/8" lock washer
1 1/4" flat washer
round pad
square pad

2 3/8"-16 x 2" bolt
3/8" lock washer
1 1/4" flat washer
round pad
square pad

11 3/8"-16 x 2" bolt
3/8" lock washer
1 1/4" lock washer
round pad
square pad

9 3/8"-16 x 2" bolt
3/8" lock washer
1 1/4" flat washer
round pad
square pad

7 3/8"-16 x 2" bolt
1 1/4" flat washer
round pad
square pad
1 1/8" flat washer
3/8"-16 nut

5 3/8"-16 x 2" bolt
1 1/4" flat washer
round pad
square pad
1 1/4" square metal washer
1 1/8" flat washer
3/8"-16 nut

3 3/8"-16 x 2" bolt
3/8" lock washer
1 1/4" flat washer
round pad
square pad

1 3/8"-16 x 2" bolt
3/8" lock washer
1 1/4" flat washer
round pad
square pad

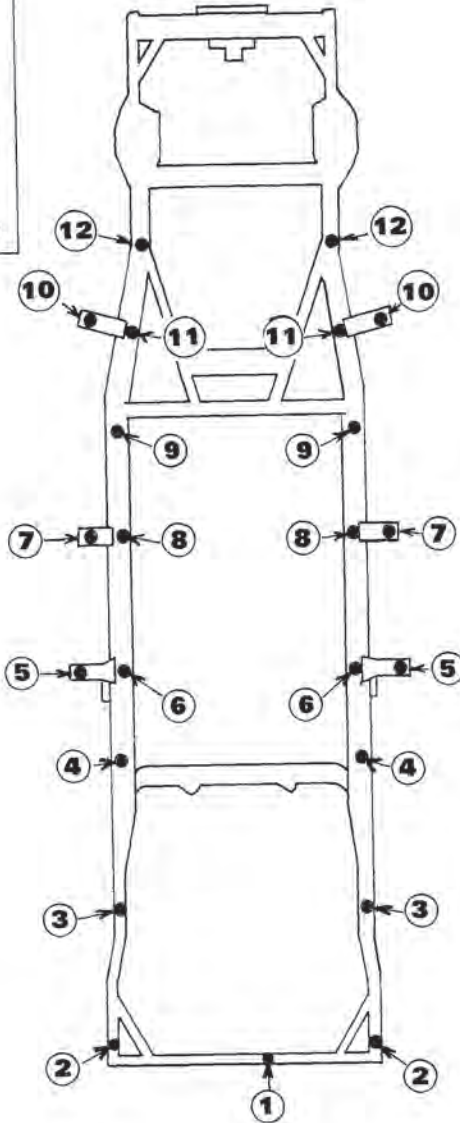

BODY TO FRAME PAD & BOLT KIT - 55-56

PART #	DESCRIPTION	YEAR	PRICE
B5A-5001	2-door & 4-door sedan only	55-56	149.95 ea.

Each kit contains:

AMOUNT	PART
6	3/8" x 2" bolts
6	3/8" x 2 1/2" bolts
4	3/8" x 3 1/2" bolts
2	3/8" x 5 1/4" studs
2	7/16" x 2 1/2" studs
16	round star washers
18	round pads
24	square pads
8	clips
6	large flat washers
8	3/8"-16 lock nuts
2	7/16"-14 lock nuts
2	1" flat washers

10 7/16" x 2 1/2" stud
square pad
1" flat washer
7/16" nut

8 3/8" x 2 1/2" bolt
round star washer
round pad
square pad
large flat washer
3/8" nut

6 3/8" x 2 1/2" bolt
round star washer
round pad
square pad
clip

4 3/8" x 3 1/2" bolt
round star washer
round pad
2 square pads
large flat washer
3/8" nut

2 3/8" x 2" bolt
round star washer
round pad
square pad

9 3/8" x 2" bolt
round star washer
round pad
square pad
clip

7 3/8" x 5 1/4" stud
round pad
square pad
large flat washer
2 3/8" nuts

5 3/8" x 2 1/2" bolt
round star washer
round pad
square pad
clip

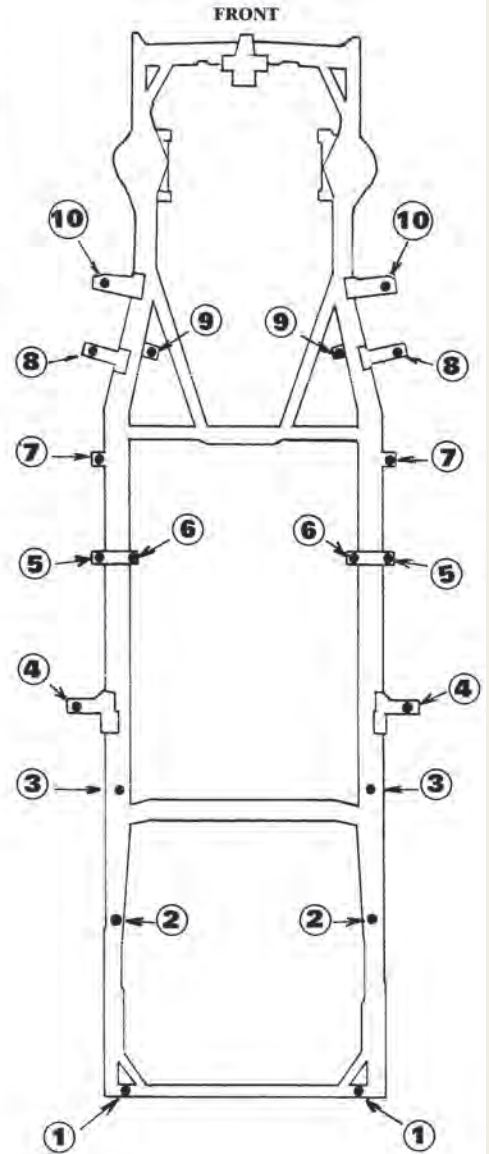

3 3/8" x 2" bolt
round star washer
round pad
2 square pads

1 3/8" x 3 1/2" bolt
round star washer
round pad
square pad
clip

BODY TO FRAME PAD & BOLT KIT - 57-58

PART #	DESCRIPTION	YEAR	PRICE
B7A-5001-A	Fits all except Retractable, Convertible, Ranchero & Wagons	57-58	199.95 kit
B7A-5001-C	Convertible	57	174.95 kit

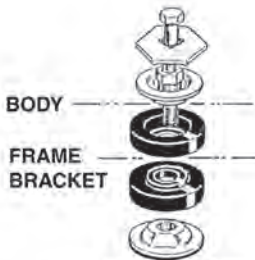

A-(7) PLACES EACH SIDE

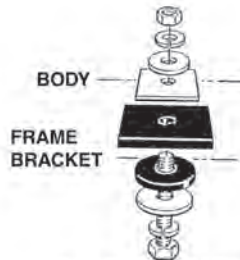

B-(1) PLACES EACH SIDE

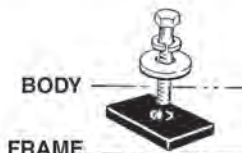

C-(1) PLACE EACH SIDE

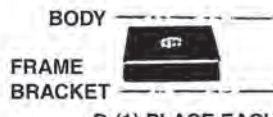

D-(1) PLACE EACH SIDE

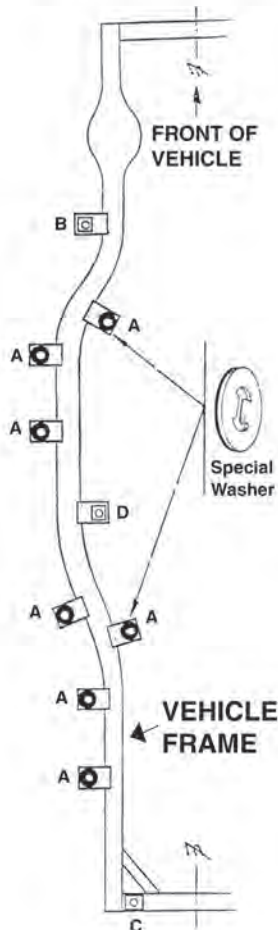

**What does it mean?
In short, it means Ford parts
made EXACTLY like originals**

ORIGINAL TOOLING describes the stamping dies, injection molds, roller dies and other tools of mass production that the Ford Motor Company used to manufacture the parts necessary to assemble their cars and trucks. (See ORIGINAL TOOLING below.)



0001

FORD Logo - A most important logo assuring customers of the true origin and authenticity of the classic parts produced from this program. They're also the company responsible for making the tooling in the first place.

0 0 0 1 - These numbers identify Dennis Carpenter Ford Restorations as the first member of a select group to manufacture parts off original tooling, parts which comply with quality standards established by Dennis Carpenter and the Ford Motor Company. What this means is that we've dusted off certain tooling and started using them again, continuing to make quality parts as good or better than the Ford originals.

ORIGINAL TOOLING in Action!

On the right is half of a 1966 Galaxie hub cap forming die mounted in a press. The first stamping operation of making the hub cap is shown below. Each cap proceeds through 9 different stamping operations before completion.



MADE ON
The ORIGINAL Ford Dies



1966 FORD GALAXIE 15" HUB CAPS

Our stamped stainless steel hubcaps are shaped and chrome plated EXACTLY Like the Ford Originals and are available with red or rose colored center caps. Red center cap #C6AZ-1130-G Rose center cap #C6AZ-1130-A



BARN FRESH

Used Flathead Parts - We're cleaning out the warehouse!
Surplus Parts from our past engine rebuilding.

SHORT BLOCKS - USED

Local Pickup Only - Sold As Is No Guarantee
- No Returns

PART #	PIC	DESCRIPTION	YEAR	PRICE
18-6010-U		21 Stud	32-36	200.00 ea.
78-6010-U		21 Stud	37	300.00 ea.
81A-6010-U		24 Stud	38-42	200.00 ea.
51A-6010-U		24 Stud	46-48	200.00 ea.
8BA-6010-U		24 Stud	49-53	200.00 ea.



CONNECTING RODS - USED

PART #	PIC	YEAR	PRICE
48-6200-U	A	32-36	5.00 ea.
21A-6200-U	B	35-38	5.00 ea.
29A-6200-U	C	39-48	5.00 ea.
8BA-6200-U	D	49-53	5.00 ea.

CYLINDER HEADS - USED

PART #	PIC	DESCRIPTION	YEAR	PRICE
18-6050-U	F	Left	33-36	75.00 ea.
18-6049-U		Right	33-36	75.00 ea.
01A-6050-U		Left or Right	38-41	75.00 ea.
59A-6050-U		Left or Right	42-48	75.00 ea.
8BA-6050-U		Left	49-53	75.00 ea.
8BA-6049-U	G	Right	49-53	75.00 ea.

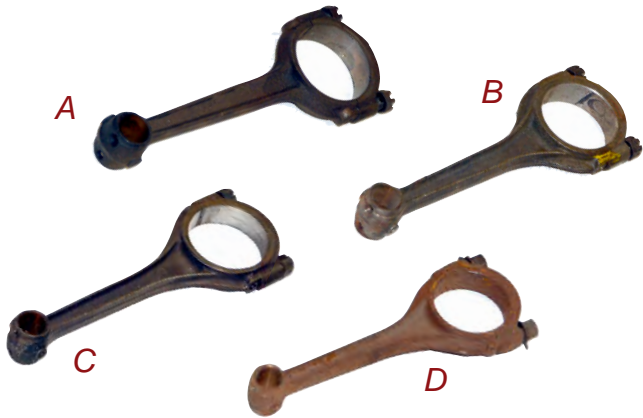

EXHAUST MANIFOLDS - USED

PART #	PIC	DESCRIPTION	YEAR	PRICE
18-9430-U		(1) pair	33-36	75.00 ea.
78-9430-U	E	(1) pair	37-41	75.00 ea.
51A-9430-U		(1) pair	42-48	75.00 ea.
8BA-9430-U		(1) pair	49-53	75.00 ea.

FLYWHEEL & RING GEAR - USED

PART #	PIC	DESCRIPTION	YEAR	PRICE
48-6375-U		90 HP & 100 HP	35-42	74.95 ea.

INTAKE MANIFOLD

PART #	PIC	DESCRIPTION	YEAR	PRICE
8BA-6520-U	H	V8	49-53	75.00 ea.



Preserving FORD History

For Future Generations



Created in 1992, the Early Ford V-8 Foundation is a 501 (c)(3) non-profit, educational organization dedicated to "Preserving 1932-1953 Early Ford V-8 History." This includes all related materials produced by the Ford Motor Company during this period, including cars and trucks. Land has been purchased in Auburn, Indiana, and an 8,000 square foot Phase 1 of our complex has been constructed. We are now raising funds to expand the facility to over 27,000 square feet. Construction began in Spring 2017. Funds for the V-8 Museum come from membership dues and donations from individuals and organizations who realize preserving this period of automotive history is important. As a non-profit corporation, the V-8 Museum can offer tax benefits for donations. Annual dues are \$25 or 3 years for \$60. Membership includes an informative bi-monthly newsletter and free admission to the Museum.

Our on-going "Buy the Foot" Campaign was created to raise funds for the expansion and maintenance of the facility. For \$150 per square foot, a certificate will be issued and your name will be added to a large plaque in the Museum. Purchase of a minimum of nine square feet gets you a custom, pewter license plate topper. Individuals, car clubs, companies and other organizations are encouraged to donate to this campaign and help the Early Ford V-8 Foundation Museum continue its mission of "Preserving Ford History" for future generations.



The future looks bright for the expansion of the Early Ford V-8 Museum. This proposal shows the Ford Rotunda inspired facade.

MEMBERSHIP APPLICATION:

U.S. & Canada \$25 Annual \$60 Three Years \$40 Foreign \$625 Life

NAME: _____

ADDRESS: _____

CITY: _____ STATE: _____ ZIP: _____

PHONE: _____ EMAIL: _____ CASH DONATION: \$ _____

DONATION IS \$150 PER SQ. FOOT FOR THE MUSEUM EXPANSION. NO. OF FEET: _____

Send Check To: Early Ford V-8 Foundation Museum, P.O. Box 284, Auburn, IN 46706

Credit Cards: Visit www.fordv8foundation.org or call 260-927-8022



EXHAUST CLAMPS/HANGERS

PART #	PIC	DESCRIPTION	YEAR	PRICE
B5A-5259-E	A	Rear Muffler Hanger	52-59	29.95 ea.
B6A-5259-A	B	Rear of Muffler Hanger w/ Dual Exhaust	Fairlane 52-56	19.95 ea.
B6A-5261-A	C	Rear of Tailpipe Hanger w/ Dual Exhaust	Fairlane 56	14.95 ea.



EXHAUST MANIFOLD - New Old Stock

PART #	PIC	DESCRIPTION	SIDE	NOTE	YEAR	PRICE
8BA-9430	D	Exhaust Manifold	RH	- N.O.S. - V-8	49-53	74.95 ea.



D Limited Supply

EXHAUST GASKETS

PART #	PIC	DESCRIPTION	NOTE	NEED	YEAR	PRICE
18-9433	E	Exhaust Manifold to Block Gasket	V-8	Need (6) per car	32-53	0.95 ea.
18-9433	E	Manifold to Crossover Pipe Gasket	V-8	Need (2) per car	32-53	0.95 ea.
18-9433-S	F	Exhaust Manifold to Block & Manifold to Crossover Pipe Gaskets	Set of (8)		32-53	7.50 set
1GA-9450	G	Exhaust Manifold to Inlet Pipe Gasket	V-8	Need (1) per car	49-59	2.95 ea.
B5A-9450-A	H	Exhaust Manifold to Crossover Pipe Gasket	8 cylinder 272		55-56	2.95 ea.



EXHAUST MANIFOLD GASKET SET FOR Y-Block

Part #	B5A-9492-S
Note	For Y-Block
Fits	239,256,272, 292,312 Motors
Year	1955-56
Price	15.95 set



STAINLESS EXHAUST DEFLECTORS

PART #	PIC	DESCRIPTION	YEAR	PRICE
51A-18529-B	I	V-8		17.95 ea.
51A-18529-A	J	Ford Script		17.95 ea.
51A-18529-P	K	Plain		14.95 ea.



THRU THE BUMPER EXHAUST DEFLECTORS

Part #	B6AZ-5202-PR	
Note	Includes RH & LH	
Year	1956	
Price	189.95 pr.	

CYLINDER HEAD GASKETS

PART #	PIC	TYPE	NOTE	ENGINE	YEAR	PRICE
8BA-6051	L	RH Side	8 cylinder		49-53	21.95 ea.
8BA-6083	M	LH Side	8 cylinder		49-53	21.95 ea.
B6A-6051-B	N	Steel	8 cylinder	272,292,312	56-62	9.95 ea.
C3TZ-6051-G	O	Steel Composite & Steel	8 cylinder	272,292,312	56-62	9.95 ea.
C8AZ-6051-A	P	Steel	8 cylinder	352	58-63	9.95 ea.

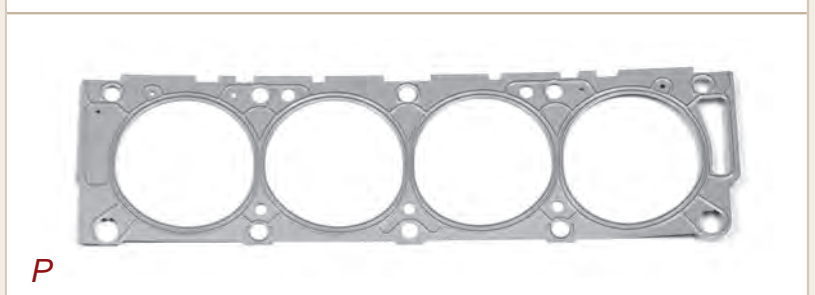
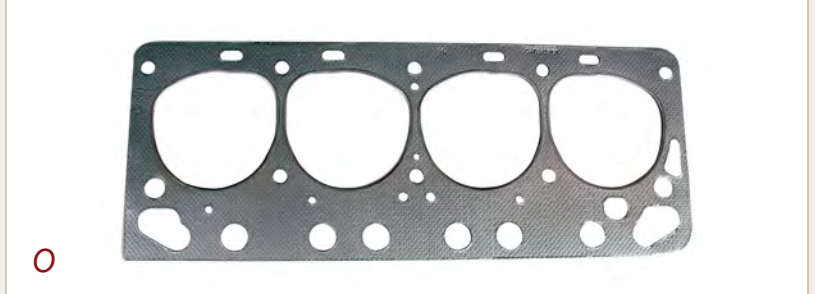
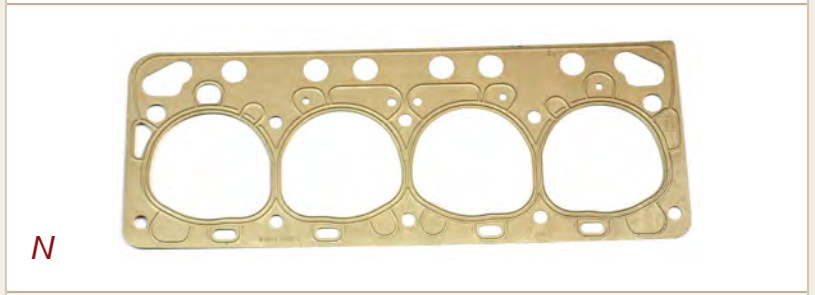
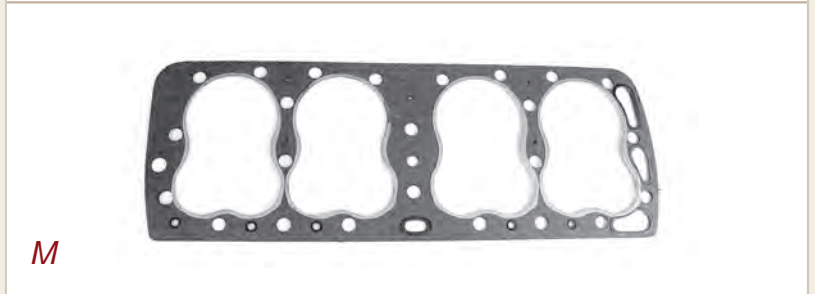
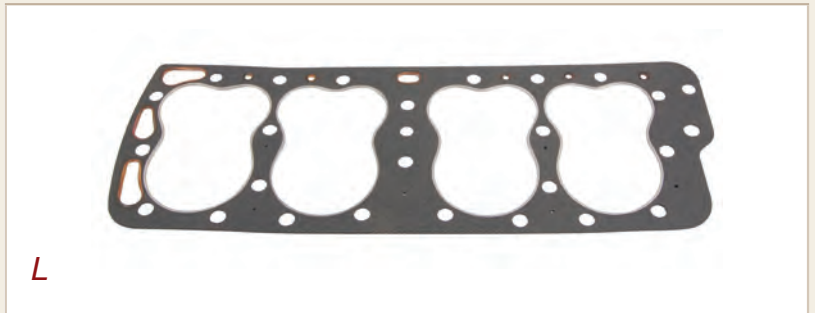

50,000 PART NUMBERS IN STOCK!

SHOP ONLINE

www.dennis-carpenter.com

OVERHAUL GASKET SET

PART #	PIC	TYPE	ENGINE	YEAR	PRICE
8BA-6008	A	8 cylinder	All	49-53	89.95 set
B6A-6008	B	8 cylinder	239,272,292,312	54-62	79.95 set
B2A-6008-A	C	6 cylinder	215,223	52-59	114.95 set

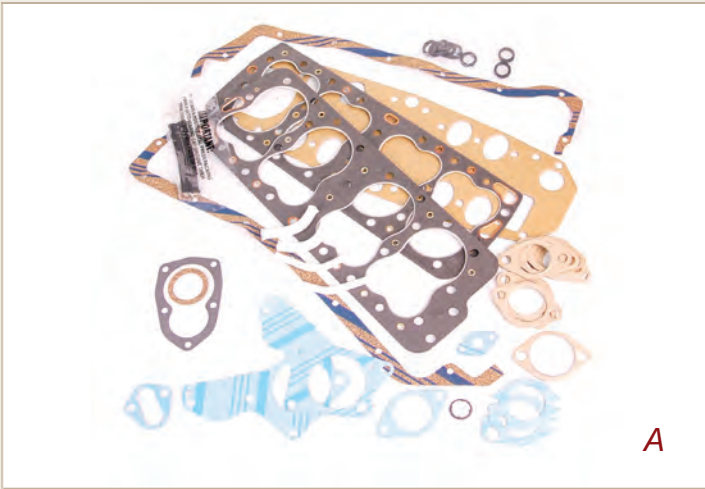

A



B



C

VALVE COVER GASKET SET

PART #	PIC	DESCRIPTION	ENGINE	YEAR	PRICE
B4AZ-6A506-A	D	8 cylinder	239,272,292,312	54-59	12.95 set
B2AZ-6A506-A	E	6 cylinder	215,223	52-59	13.95 set

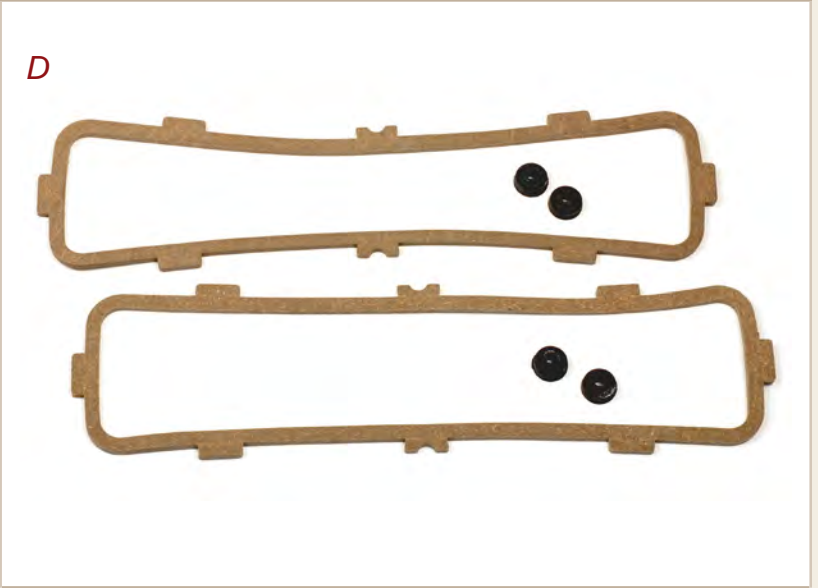

D

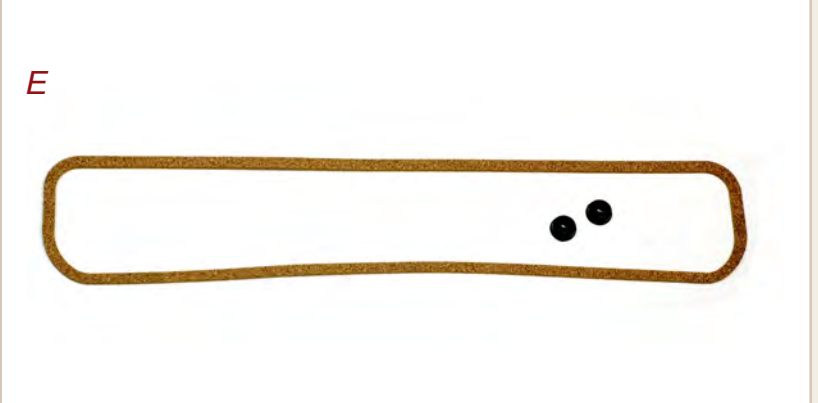

E

FRONT TIMING COVER GASKET & SEAL KIT

PART #	PIC	DESCRIPTION	ENGINE	YEAR	PRICE
B4AZ-6020-SET	F	V-8	239,272,292,312	54-62	24.95 kit
EBP-6020-SET		6 cylinder	215, 223	52-64	11.95 kit



F

\$9.99 *or* **\$14.99** **FLAT RATE SHIPPING**
See shipping page for details.



OIL PAN GASKET SET

PART #	PIC	DESCRIPTION	YEAR	PRICE
8BA-6710-B	G	8 cylinder	All	49-53 19.95 set
C0AZ-6710-B	H	8 cylinder	272,292,312	54-62 19.95 set
C0AE-6710-A	I	6 cylinder	215,223	52-64 15.95 set
C0AE-6710-C	J	8 cylinder	332, 352	58-59 12.95 set



G



H

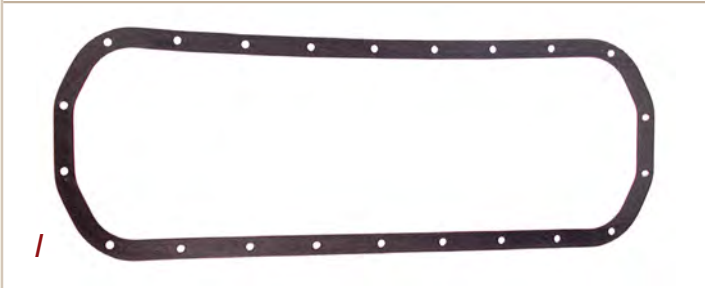

I



J

VALVE GRIND GASKET SET

PART #	PIC	DESCRIPTION	ENGINE	YEAR	PRICE
B7AZ-6079-D	K	8 cylinder	272, 292, 312	56-62	29.95 set

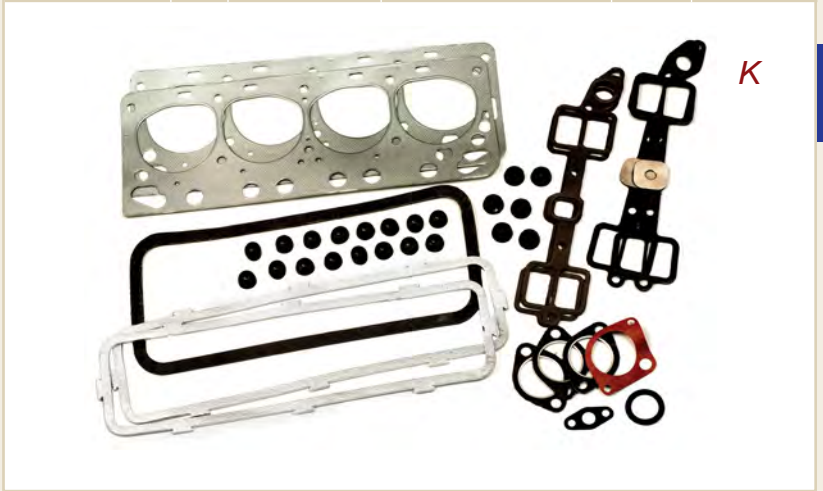

K

INTAKE MANIFOLD GASKET

PART #	PIC	DESCRIPTION	YEAR	PRICE
8BA-6521	L	8 cylinder	49-53	16.95 ea.
B7AZ-9433-A	M	8 cylinder	55-62	9.95 set
B6A-9461-A		6 cylinder	223 - NOS	56-59 10.00 ea.



L



M

INTAKE MANIFOLD TO BLOCK SLEEVE

Mounts into manifold openings

PART #	PIC	DESCRIPTION	YEAR	PRICE
B6A-9471-A		223 - 6 cyl. - Split - 1.62" O.D. - .30" long - Takes (4)	56-59	8.00 ea.

\$9.99 or **\$14.99** **FLAT RATE SHIPPING**
 See shipping page for details.
No matter how much you order!

PISTONS - V8

PART #	DESCRIPTION	ENGINE	YEAR	PRICE
3-3/16" Bore Sold in sets of (8)				
8BA-6108-STD	Standard Size	8 cyl. 239	49-53	199.95 set
8BA-6108-020	.020 Oversize	8 cyl. 239	49-53	199.95 set
8BA-6108-030	.030 Oversize	8 cyl. 239	49-53	199.95 set
8BA-6108-040	.040 Oversize	8 cyl. 239	49-53	199.95 set
8BA-6108-060	.060 Oversize	8 cyl. 239	49-53	199.95 set
3.7503" Std Bore Sold in sets of (8)				
B5A-6108-STD	Standard	8 cyl. 292	55-62	99.95 set
B5A-6108-020	.020 Oversize	8 cyl. 292	55-62	99.95 set
B5A-6108-030	.030 Oversize	8 cyl. 292	55-62	99.95 set
B5A-6108-040	.040 Oversize	8 cyl. 292	55-62	99.95 set
B5A-6108-060	.060 Oversize	8 cyl. 292	55-62	99.95 set

PISTON RINGS - V8

PART #	DESCRIPTION	YEAR	PRICE
8BA-6149-STD	Standard	8 cyl. 239	49-53 79.95 set
8BA-6149-020	.020 Oversize	8 cyl. 239	49-53 79.95 set
8BA-6149-030	.030 Oversize	8 cyl. 239	49-53 79.95 set
8BA-6149-040	.040 Oversize	8 cyl. 239	49-53 79.95 set
8BA-6149-060	.060 Oversize	8 cyl. 239	49-53 79.95 set
B5AZ-6148-STD	Standard	8 cyl. 292	55-62 39.95 set
B5AZ-6148-020	.020 Oversize	8 cyl. 292	55-62 39.95 set
B5AZ-6148-030	.030 Oversize	8 cyl. 292	55-62 39.95 set
B5AZ-6148-040	.040 Oversize	8 cyl. 292	55-62 39.95 set
B5AZ-6148-060	.060 Oversize	8 cyl. 292	55-62 39.95 set

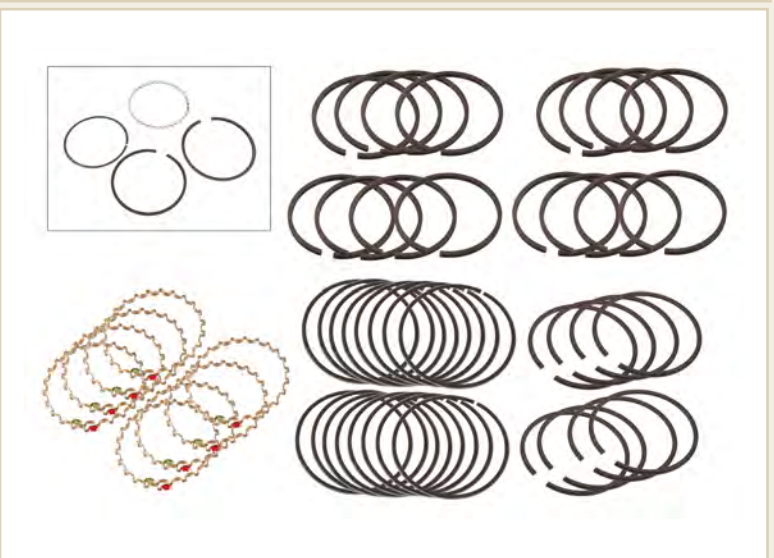

DENNIS-CARPENTER.COM
Shop Online
 Fully secure ordering - Open 24/7 - Find parts by year, description, or category.

Weather Stripping • Die Cast Emblems • Taillight Lenses • Sheet Metal • Switches • Knobs • Upholstery • & more!

1932-96 Ford Truck • 1932-79 Ford Cars
 1939-64 Ford Tractors • Cushman Scooters



CAMSHAFTS & RELATED

PART #	PIC	DESCRIPTION	TYPE	ENGINE	YEAR	PRICE
--------	-----	-------------	------	--------	------	-------

Camshaft ASSEMBLY

7RT-6252	A	Camshaft Assembly	V-8 - New Old Stock - Limited Supply		48-53	149.95 ea.
B8A-6250-C	B	Camshaft Assembly	8 cylinder - Limited Supply	272, 292, 312	56-62	69.95 ea.

Camshaft BEARING SET

*01A-6260-S	C	Camshaft Bearing Set (Set of 3)	Front, Rear, & Center - 8 cylinder		49-53	49.95 set
C3TZ-6A251-A	D	Camshaft Bearing Set (Set of 5)	Standard - 8 cylinder	272, 292, 312	55-62	29.95 set

Camshaft TIMING GEAR & CHAIN

*8BA-6256-A	E	Camshaft Timing Gear	8 cylinder - Aluminum		49-53	64.95 ea.
EAA-6256	F	Camshaft Timing Gear	6 cylinder	215, 223	52-64	27.95 ea.
EAA-6256	F	Camshaft Timing Gear	8 cylinder	239, 272, 292, 312	54-62	27.95 ea.
EAA-6268	G	Timing Chain	6 cylinder	215, 223	52-64	22.95 ea.
EAA-6268	G	Timing Chain	8 cylinder	239, 272, 292, 312	54-62	22.95 ea.

Camshaft THRUST PLATE

EAA-6269-A	H	Camshaft Thrust Plate	6 cylinder	215, 223	52-64	9.95 ea.
EAA-6269-A	H	Camshaft Thrust Plate	8 cylinder	239, 272, 292, 312	54-62	9.95 ea.

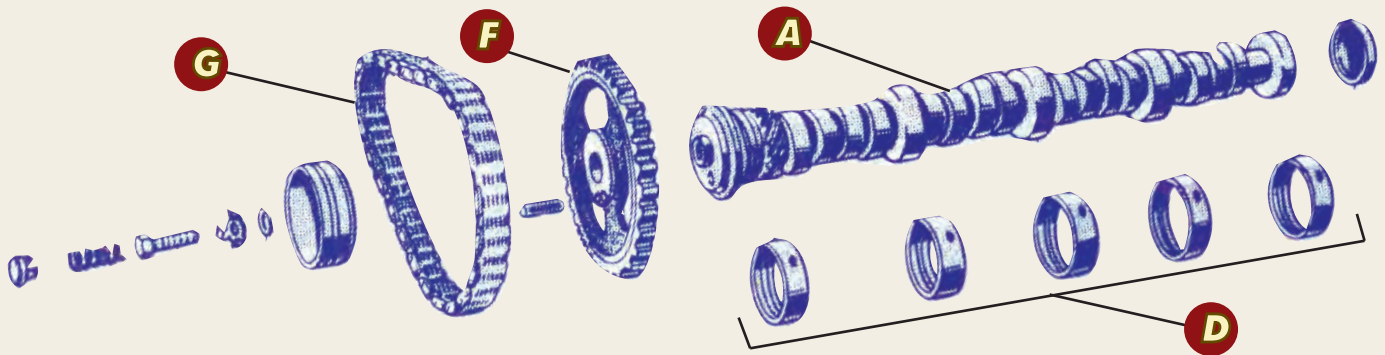

CONNECTING ROD BEARINGS - V8

PART #	DESCRIPTION	YEAR	PRICE
*0BA-6211-STD	Standard	49-53	99.95 set
*0BA-6211-010	.010 Oversize	49-53	99.95 set
*0BA-6211-020	.020 Oversize	49-53	99.95 set
*0BA-6211-030	.030 Oversize	49-53	99.95 set
*0BA-6211-040	.040 Oversize	49-53	99.95 set
B5T-6211-020	.020 Undersize	8 cyl. 239,272,292,312	54-62 19.95 set
B5T-6211-030	.030 Undersize	8 cyl. 239,272,292,312	54-62 19.95 set
B4AE-6211-040	.040 Undersize	8 cyl. 239,272,292,312	54-62 19.95 set



MOTOR MOUNTS

PART #	PIC	DESCRIPTION	YEAR	PRICE
FRONT Motor Mount				
8BA-6038	A	6 & 8 cylinder	Need (2) per car	49-53 14.95 ea.
B7A-6038-B	C	8 cylinder	Need (2) per car	54-58 19.95 ea.
B9A-6038-A	D	6 cylinder 223		59-60 14.95 ea.
REAR Motor Mount				
AD-6068	E	6 & 8-cylinder	Need (1) per car	51-56 19.95 ea.
B7A-6068-A	F	8 cylinder		57-60 12.50 ea.



CONNECTING ROD WRIST PIN BUSHINGS

Part #	*21A-6207-A
Year	1949-53
Price	2.95 ea.



ENGINE PAINT (Sold by the Quart)

PART #	PIC	DESCRIPTION	YEAR	PRICE
BA-6000		Orange	52-53	39.95 qt.
B5S-6000		Red	55-57	39.95 qt.



Highest quality, hi-temp., hi-gloss. Gives you a factory look finish. Rated to 700 degrees F. which is the highest on the market.

Nothing else compares.

ENGINE TO DASH GROUND WIRE

Part #	14303-AR
Year	1955-64
Price	3.95 ea.



Engine Ground Strap (to body or frame) 12 Wire Mesh - Universal

Part #	D1PZ-14303-A
Year	ALL
Price	9.95 ea.

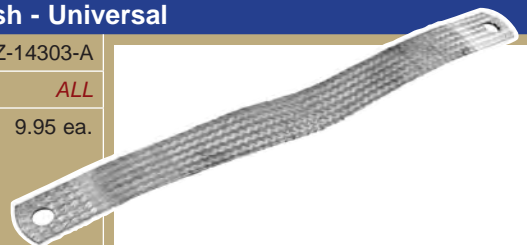

CRANKSHAFT RELATED PARTS

PART #	PIC	DESCRIPTION		YEAR	PRICE
*8BA-6306	G	Crankshaft Timing Gear	V-8	49-53	39.95 ea.
B8A-6306-B	H	Crankshaft Timing Gear	6 cyl. 215, 223	52-64	9.95 ea.
B8A-6306-B	H	Crankshaft Timing Gear	8 cyl. 239, 272, 292, 312	54-62	9.95 ea.
*8BA-6312-C	I	Crankshaft Pulley	For Narrow Belts	49-53	74.95 ea.
*8BA-6362	J	Crankshaft Pulley Extension	V-8	49-53	9.95 ea.
*8BA-6411	K	Crankshaft Dust Seal	8-cylinder	49-53	14.95 ea.



G



H



I



J

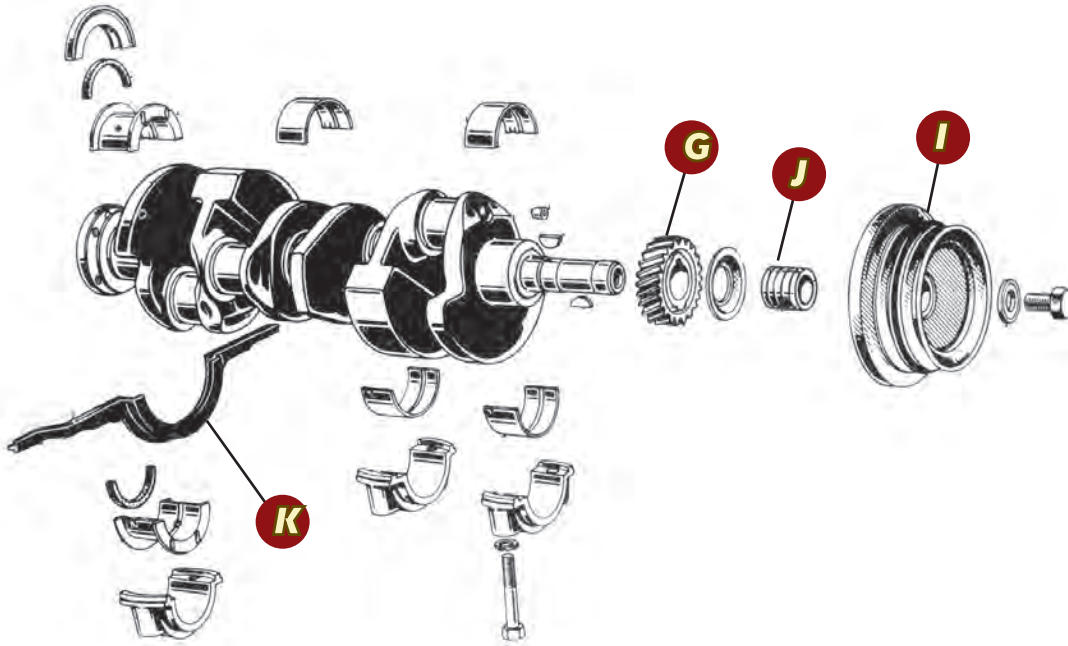

K



MAIN BEARINGS - V8

PART #	DESCRIPTION	ENGINE	YEAR	PRICE
*1BA-6330-STD	Standard		49-53	89.95 set
*1BA-6330-010	.010 Oversize		49-53	89.95 set
*1BA-6330-020	.020 Oversize		49-53	89.95 set
*1BA-6330-030	.030 Oversize		49-53	89.95 set
EBV-6330-020	-.020 U/S	8 cyl. 239,272,292	54-62	74.95 set
EBV-6330-030	-.030 U/S	8 cyl. 239,272,292	54-62	59.95 set
B4AE-6330-040	-.040 U/S	8 cyl. 239,272,292	54-62	59.95 set



8 Cylinder
292 Engine

VALVE PUSH RODS

PART #	PIC	DESCRIPTION	YEAR	PRICE
EAA-6565-C	A	- Solid Lift - 6 cylinder - 223 - 9 43/64"L	52-64	3.95 ea.
*C8AZ-6565-A	A	- Hydraulic - 8 cylinder - 332,352,390 - .030" U/S	58-64	2.95 ea.

VALVE TAPPET

PART #	PIC		YEAR	PRICE
8BA-6500-A		8 cyl.	49-53	14.95 ea.
B8C-6500-A	B	6 cyl. 215,223	52-64	14.95 ea.
B8C-6500-A	B	8 cyl. 239,272, 292, 312	54-62	14.95 ea.

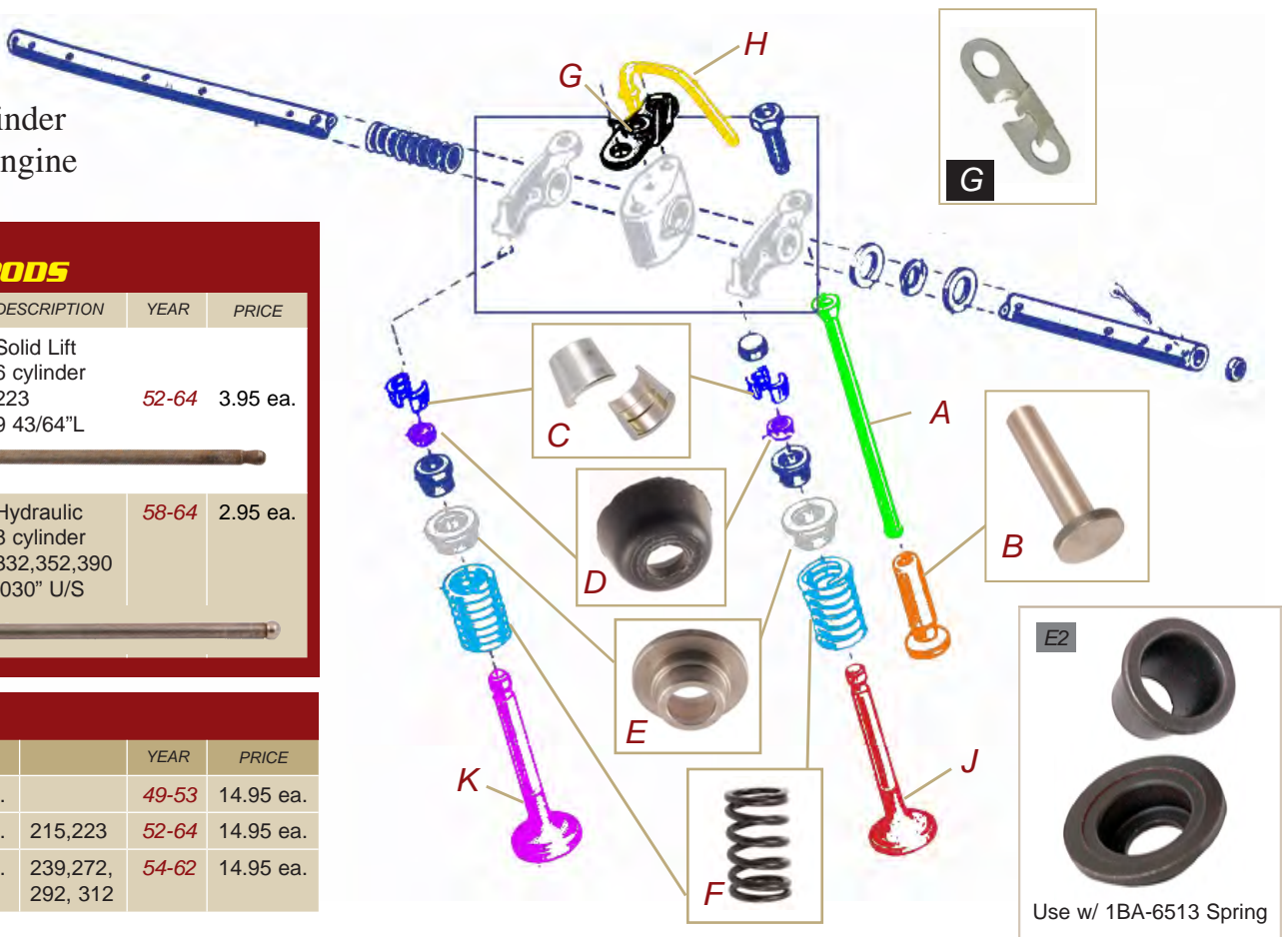

Use w/ 1BA-6513 Spring

ADJUSTABLE TAPPET SET

Part #	91A-6500-SET
Type	- V-8 - Hollow Design
Note	Set of (16)
Note	w/ Wrench
Year	1932-53
Price	214.95 set



TAPPET WRENCHES
(Adjusts 91A Tappets)

Part #	T-6500-PR
Year	1932-53
Price	9.95 pr.



VALVE PARTS

PART #	PIC	DESCRIPTION	TYPE	ENGINE	YEAR	PRICE
Valve KEEPERS						
*7HA-6518	C	Keeper	6 cylinder		54-64	0.95 pr.
*7HA-6518	C	Keeper	8 cylinder		49-62	0.95 pr.
Valve GUIDE & STEM SEAL						
C1TE-6571-C	D	Individual Seal	6 cylinder	223	54-62	0.95 ea.
C1TE-6571-C	D	Individual Seal	8 cylinder	239,272,292,312	54-62	0.95 ea.
Valve SPRING RELATED						
8BA-6514	E	Spring Retainer	8 cylinder		49-53	1.95 ea.
*1BA-6514-PR	E2	Spring Retainer & Sleeve	8 cylinder		49-53	4.95 pr.
1BA-6513	F	Spring	8 cylinder		51-53	4.95 ea.
B6A-6513	F	Spring	6 cylinder	223	52-59	1.25 ea.
B6A-6513	F	Spring	8 cylinder	272,292,312	54-59	1.25 ea.
B8A-6513-C	F	Spring	8 cylinder	332,352		1.95 ea.

VALVE ROCKER ARM PARTS

PART #	PIC	DESCRIPTION	TYPE	ENGINE	YEAR	PRICE
EBU-6575-A	G	Oil Outlet Tube Bracket	8 cylinder	239,272,292,312	54-63	2.95 ea.
B5A-6588-A		Rocker Arm Shaft Oil Outlet Tube		239,256,272,292	54-64	0.00 ea.



VALVES

PART #	VALVE TYPE	HEAD DIAMETER	STEM DIAMETER	LENGTH	TYPE	ENGINE	YEAR	PRICE
J EXHAUST Valves								
*1BA-6506	EXHAUST				8 cylinder	use w/ solid type guide	51-53	9.95 ea.
C3AZ-6505-A	EXHAUST		Standard		6 cylinder	215, 223	54-62	9.95 ea.
C3AZ-6505-A	EXHAUST		Standard		8 cylinder	239, 272, 292, 312	52-64	9.95 ea.
C3AZ-6505-C	EXHAUST		.015		6 cylinder	215, 223	54-62	9.95 ea.
C3AZ-6505-C	EXHAUST		.015		8 cylinder	239, 272, 292, 312	52-64	9.95 ea.
C3AZ-6505-D	EXHAUST		.030		6 cylinder	215,223	54-62	9.95 ea.
C3AZ-6505-D	EXHAUST		.030		8 cylinder	239,272,292,312	52-64	9.95 ea.



PART #	VALVE TYPE	HEAD DIAMETER	STEM DIAMETER	LENGTH	TYPE	ENGINE	YEAR	PRICE
K INTAKE Valves								
*1BA-6506	INTAKE				8 cylinder	use w/ solid type guide	51-53	9.95 ea.
B7A-6507-AA	INTAKE	1.92"	.3420"	5.02"	8 cylinder	272,292,312	57-59	9.95 ea.
C0ME-6507-N	INTAKE	1.65"	.3420"	5.02"	6 cylinder	215	52-53	9.95 ea.
C0ME-6507-N	INTAKE	1.65"	.3420"	5.02"	8 cylinder	239	54	9.95 ea.
C0ME-6507-N	INTAKE	1.65"	.3420"	5.02"	8 cylinder	292	60-62	9.95 ea.
C0ME-6507-S	INTAKE	1.65"	.3450"	5.02"	6 cylinder	215	52-53	9.95 ea.
C0ME-6507-S	INTAKE	1.65"	.3450"	5.02"	8 cylinder	239	54	9.95 ea.



VALVE GUIDES & KEEPERS - V-8

PART #	PIC	DESCRIPTION	YEAR	PRICE
*8BA-6510	L	Valve Guide	49-53	4.95 ea.
*8BA-6510-S	L	Valve Guide Set (16)	49-53	74.95 set
*40-6512	M	Valve Guide Keeper	49-53	0.95 ea.
*40-6512-S	M	Valve Guide Keeper Set (16)	49-53	14.95 set



INTAKE VALVE GUIDE SEAL SET

Part #	*8BA-6571
Type	V-8
Note	Set of (8)
Year	1949-53
Price	2.95 set



\$9.99 or **\$14.99** **FLAT RATE SHIPPING**
See shipping page for details.



CYLINDER HEAD

(Genuine FORD, New in box)

Part #	C3TZ-6049-G
Type	
Note	Casting #C3TZ-6048-FG
Fits	8 cyl. 272,292,312
Year	1955-62
Price	99.95 ea.

Must use C0ME-6507-N
Intake valves

Replacement Type

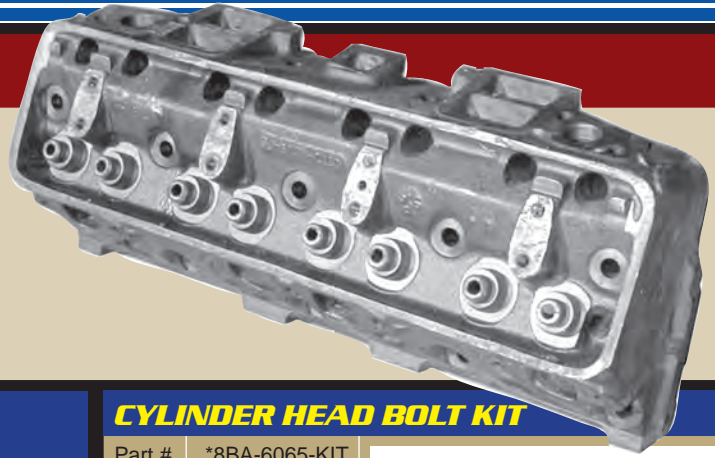

CYLINDER HEAD BOLTS

(Individually Sold)

Part #	*8BA-6065
Type	1.94" long
Note	Need (10) per head
Fits	8-cylinder
Year	1949-53
Price	1.95 ea.



Part #	*8BA-6066
Type	2.62" long
Note	Need (14) per head
Fits	8-cylinder
Year	1949-53
Price	2.50 ea.



CYLINDER HEAD BOLT KIT

Part #	*8BA-6065-KIT
Note	Includes: (20) 8BA-6065 (28) 8BA-6066
Fits	Does 1 engine
Year	1949-53
Price	89.95 ea.



FORD FLATHEAD CYLINDER HEADS

Original Edelbrock Design

Part #	8BA-6050-1115
Type	Finned Type
Note	24 Stud
Fits	Ford / Mercury
Year	1949-53
Price	649.95 pr.



- Rugged, ribbed internally and externally, with a large water capacity and excellent breathing characteristics.
- Cast at the Edelbrock Foundry in the USA of T-6 tempered A356 aluminum.
- 8.0:1 compression ratio on blocks with a 3/16" base relief (stock bore and stroke)

HIGH LIFT / LARGE CHAMBER FORD FLATHEADS

Part #	8BA-6050-1116
Type	Finned Type
Note	24 Stud
Fits	Ford / Mercury
Year	Late Model 1949-53
Price	699.95 pr.



- Supports high lift cams & is perfect for reducing compression in supercharger applications or on low octane fuel
- Features new "raised roof" combustion chamber design that is CNC machined from our popular #1115 Flathead casting
- Increased valve clearance and increased flow for more power

TRIPLE DEUCE MANIFOLD

Part #	8BA-6520-1109
Year	1949-53
Price	329.95 ea.



- These reproductions of the vintage Edelbrock manifold #SU 359 and #SU 349 allow the use of three 2-barrel carburetors on 1938-48 and 1949-53 Ford Flathead engines.
- #1109 features front road draft and 1 3/8" diameter oil fill bosses, and a raised fuel pump boss.

\$9.99 *or* **\$14.99**

FLAT RATE SHIPPING

See shipping page for details.

50,000 PART NUMBERS IN STOCK!

SHOP ONLINE

www.dennis-carpenter.com

OIL FILTER & OIL FILTER ELEMENT

PART #	PIC	DESCRIPTION	TYPE	YEAR	PRICE
Oil FILTER					
D9AZ-6731-A	A	Motorcraft - FL1A	Spin on Type	54-59	8.95 ea.
C2AZ-6731-B		w/ Check Valve	Spin on Type	54-59	8.95 ea.

Oil Filter ELEMENT

7HA-6731-A	B	6 cylinder		40-51	14.95 ea.
7HA-6731-A	B	8 cylinder		40-51	14.95 ea.
B2A-6731-A		6 cylinder	Original Canister Type	52-56	14.95 ea.
B2A-6731-A		8 cylinder	Original Canister Type	54-58	14.95 ea.

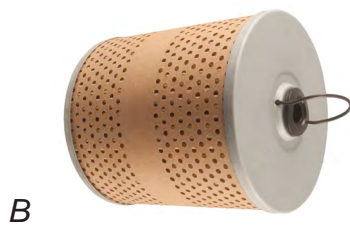

ENGINE OIL

PART #	TYPE	YEAR	PRICE
H-10687	10W30	36-65	9.50 ea.
H-10688	10W40	36-65	9.50 ea.

- For Muscle, Classic & Trophy cars without catalytic converters
- Zinc value is 2100 PPM
- Has ZDDP (zinc) additive for flat tappet engines



OIL FILTER CONVERSION KIT

Part #	B7A-6882-A	
Type	To convert from canister type to spin on type oil filter.	
Note	Uses D9AZ-6731-A or C2AZ-6731-B (not included)	
Year	1954-58	
Price	24.95 ea.	

OIL FILTER DECALS

PART #	PIC	DESCRIPTION	YEAR	PRICE
DF-64	E	Oil Filter Decal	40-53	4.95 ea.
DF-375	F	Ford Oil Filter Decal Set	52-53	11.95 ea.



F



OIL PUMP ASSEMBLY - NEW

Part #	8BA-6621
Type	8 cylinder
Year	1949-53
Price	219.95 ea.



Part #	C0AE-6600-D
Type	8 cylinder
Fits	272,292,312 (external)
Year	1955-64
Price	189.95 ea.



CRANKCASE BREATHER SCREEN

Part #	B2TZ-6A631-A
Type	8-cylinder
Fits	239,272,292,312
Year	1954-56
Price	6.95 ea.



OIL PAN TO PICKUP TUBE SEAL

Part #	B4A-6698-A
Type	Y-Block
Fits	239,272,292,312
Year	1954-62
Price	7.95 ea.



OIL PAN DRAIN PLUG

Part #	D1AZ-6730-A
Note	1/2 - 20
Fits	6 & 8 cylinder
Year	1954-72
Price	4.95 ea.



OIL PAN DRAIN PLUG GASKET

Part #	C20Z-6734-A
Note	Included with D1AZ-6730-A
Size	13/16" O.D. x 1/2" I.D. x 5/64" Thick
Fits	6 & 8 cylinder
Year	1960-72
Price	2.95 ea.



OIL PUMP SCREEN

Part #	41A-6623
Type	6 & 8 cylinder
Year	V8 - 49-53 Y-Block - 54-62
Price	14.95 ea.



OIL PRESSURE SENDING UNITS

Part #	*41A-9278
Type	V8
Note	for Guage
Year	1949-53
Price	39.95 ea.



Part #	B6A-9278
Type	12V
Note	w/ warning lights
Year	1954-64
Price	9.95 ea



OIL FILLER CAP

PART #	PIC	TYPE	ENGINE	NOTE	YEAR	PRICE
*8BA-6766	J	V-8	239	Black	49-53	19.95 ea.
EAD-6766-B	K	8 cylinder	272,292,312		54-64	9.95 ea.
B5A-6766-R	L	V-8		Painted Black	54-56	19.95 ea.
B5S-6766-A	M	V-8		Chrome	54-56	33.95 ea.
C0AZ-6766-A	N	6 cylinder	223	Replacement - Black	54-64	6.95 ea.
B6A-6766-A	O	V-8		Original - Black	57-59	24.95 ea.



GEAR SHIFT KNOBS

PART #	PIC	DESCRIPTION	YEAR	PRICE
8A-7213	G	Black	52-53	6.95 ea.
B6C-7213	H	Black	54-56	6.95 ea.



GEAR SHIFT INSULATOR

PART #	PIC	DESCRIPTION	NOTE	YEAR	PRICE
01A-7246-B	P	For Straight Drive	Rubber	40-59	5.95 ea.
1M-7246-A	Q	Automatic Transmission	Rubber	51-60	7.95 ea.

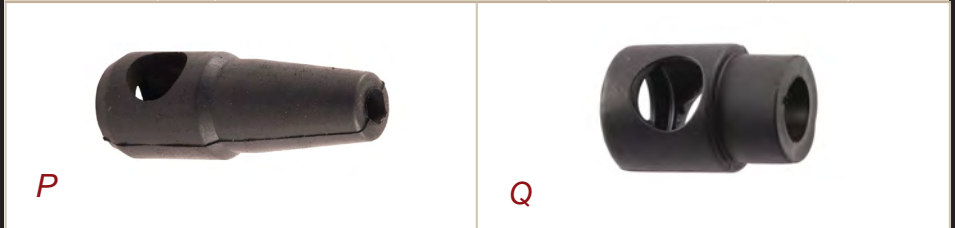

GEAR SHIFT LEVER PIN
- Need (2) per car

PART #	YEAR	PRICE	PIC
01A-7221	40-53	5.95 ea.	

SHIFTER BUSHING SET

Part #	C3TZ-7343-A
Type	Manual Transmission Column Shift
Year	1957-66
Price	4.95 pr.



SIDE OF TRANSMISSION SHIFT ARM

PART #	PIC	DESCRIPTION	NOTE	YEAR	PRICE
AB-7285-B	R	For 2nd & 3rd gear	Standard & Overdrive	52-54	11.95 ea.
AB-7285-B	R	For 2nd & 3rd gear	Standard	55-56	11.95 ea.
B5A-7290-A	S	For Low & Reverse	Standard	55-56	11.95 ea.



What does it mean? In short, it means Ford parts made EXACTLY like originals

ORIGINAL TOOLING describes the stamping dies, injection molds, roller dies and other tools of mass production that the Ford Motor Company used to manufacture the parts necessary to assemble their cars and trucks. (See ORIGINAL TOOLING below.)



0001

FORD Logo - A most important logo assuring customers of the true origin and authenticity of the classic parts produced from this program. They're also the company responsible for making the tooling in the first place.

0 0 0 1 - These numbers identify Dennis Carpenter Ford Restorations as the first member of a select group to manufacture parts off original tooling, parts which comply with quality standards established by Dennis Carpenter and the Ford Motor Company. What this means is that we've dusted off certain tooling and started using them again, continuing to make quality parts as good or better than the Ford originals.

ORIGINAL TOOLING in Action!

On the right is half of a 1966 Galaxie hub cap forming die mounted in a press. The first stamping operation of making the hub cap is shown below. Each cap proceeds through 9 different stamping operations before completion.



MADE ON
The ORIGINAL Ford Dies



1966 FORD GALAXIE 15" HUB CAPS

Our stamped stainless steel hubcaps are shaped and chrome plated EXACTLY Like the Ford Originals and are available with red or rose colored center caps.
Red center cap #C6AZ-1130-G Rose center cap #C6AZ-1130-A



AUTOMATIC TRANSMISSION SELECTOR BULB

PART #	PIC	DESCRIPTION	YEAR	PRICE
78-13466-55	A	6 volt	55	1.50 ea.
B6A-13466-57	B	12 volt	56	0.95 ea.

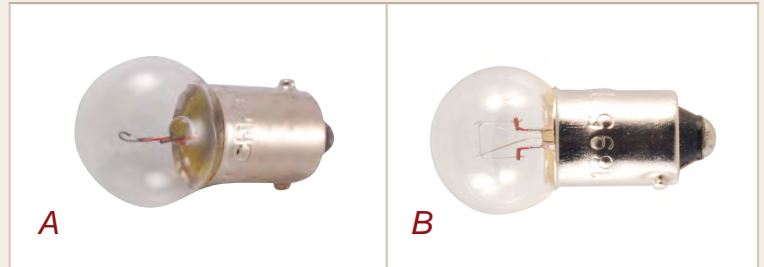

NEUTRAL SAFETY SWITCH

Name	Neutral Safety Switch
Part #	B7AZ-7A247-A
Note	
Year	1955-57
Price	39.95 ea.



STARTER SWITCH TO NEUTRAL SAFETY SWITCH WIRE

PART #	PIC	DESCRIPTION	YEAR	PRICE
FAA-14476-A	C	-	52-53	9.95 ea.
FDR-14476-A	D	-	56	16.95 ea.



SHIFTER BUSHING SET

PART #	PIC	DESCRIPTION	YEAR	PRICE
B9AZ-7343-A		- Automatic Floor Shift	57-64	7.99 ea.



TRANSMISSION REAR HOUSING SEAL

PART #	PIC		YEAR	PRICE
*21C-7052-A	E	6 & 8 cylinder	223,239,272,292	49-56 5.95 ea.
C1AP-7052-B	F	8 cylinder	312,332,352	56-65 9.95 ea.

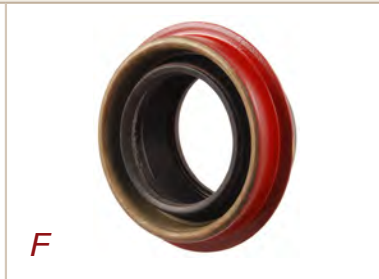

TRANSMISSION EXTENSION HOUSING REAR BUSHING

Standard Overdrive
All 8 cylinder 312,332,352 w/ Overdrive

PART #	PIC	SIZE	YEAR	PRICE
B3TZ-7A034-A	G	1 1/2" I.D. x 1 5/8" O.D.	49-59	9.95 ea.
B5AZ-7A034-A	H	1.8175" O.D.	58-59	12.50 ea.



TRANSMISSION INPUT & OUTPUT SHAFT BEARING

Part #	74-7025
Note	2.832 O.D.
Year	1949-59
Price	39.95 ea.



TRANSMISSION DIPSTICK FORD-O-MATIC

PART #	YEAR	PRICE
B5AZ-7A020-A	55-58	29.95 ea.

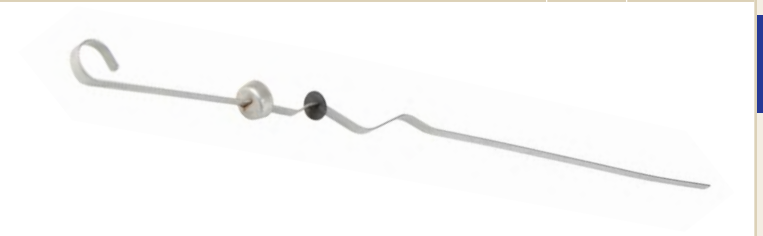

TRANSMISSION OIL PAN SCREEN

PART #	DESCRIPTION	YEAR	PRICE
B9AP-7A098-B	Ford-O-Matic, Cruise-O-Matic, FX Trans	51-67	11.95 ea.



TRANSMISSION OVERHAUL GASKET SET

PART #	YEAR	PRICE
8A-7153-A	49-59	14.95 set



UNIVERSAL JOINT

PART #	PIC	DESCRIPTION	YEAR	PRICE
1M-7039	I	Universal Joint - Rear	49-56	49.95 ea.
1M-7042-A	J	Universal Joint - Front	49-56	26.95 ea.

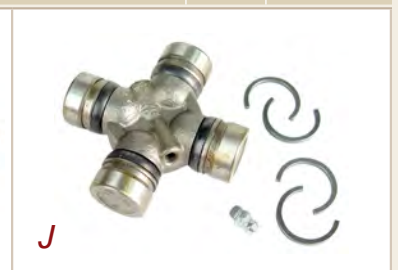
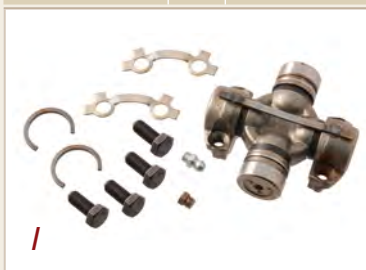

CLUTCH DISC & PRESSURE PLATE

PART #	PIC	DESCRIPTION	TYPE	SIZE	YEAR	PRICE
8BA-7550-N	A	Clutch Disc	8 cylinder	9-1/2"	49-53	49.95 ea.
8BA-7550-N	A	Clutch Disc	6 cylinder	9-1/2"	49-57	49.95 ea.
B5A-7550-N		Clutch Disc	8 cylinder	10"	54-56	54.95 ea.
1A-7563-N	B	Clutch Pressure Plate	8 cylinder	9-1/2"	49-53	119.95 ea.
1A-7563-N	B	Clutch Pressure Plate	6 cylinder	9-1/2"	49-59	119.95 ea.
19A-7563-N	B	Clutch Pressure Plate	8 cylinder	10"	54-59	99.95 ea.
8A-7580-A	C	Clutch Release Bearing			49-59	24.95 ea.
B-7600	D	Clutch Pilot Bearing			49-59	5.95 ea.

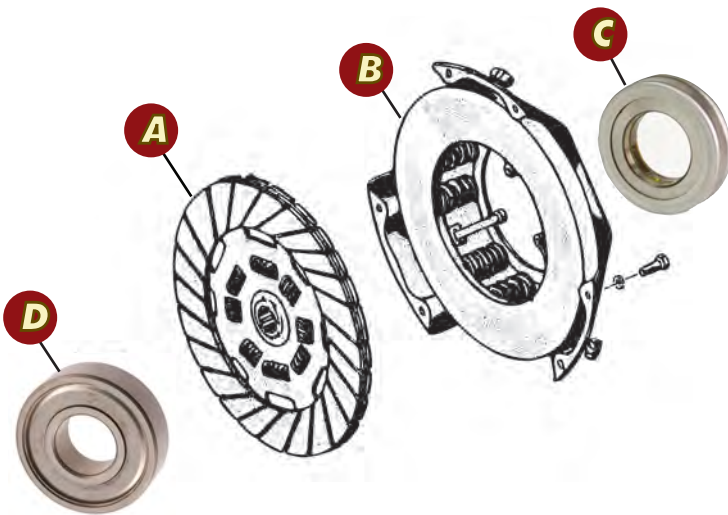
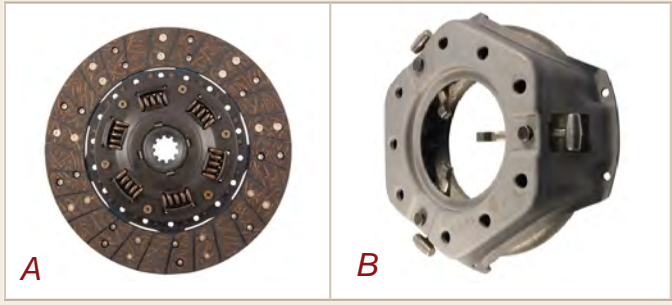

CLUTCH PARTS

PART #	PIC	DESCRIPTION	YEAR	PRICE
01A-7517	E	Clutch Release Equalizer Shaft Bushing	52-59	4.95 pr.
MB-7523-A		Clutch Return Spring	52-54	4.95 ea.
01A-7539-A	F	Clutch Release Arm Shaft Washer - Rubber	52-59	0.95 ea.
01A-7545	G	Clutch Release Arm Shaft Spring	52-59	1.95 ea.
BA-7527	H	Clutch Pedal Rod to Firewall Seal	52-56	14.95 ea.
B7A-7527-A	I	Clutch Pedal Rod to Firewall Seal	57-59	0.95 ea.
MA-7583-A	J	Clutch & (Brake) Pedal Arm Bumper-2 per car	52-59	1.95 ea.



Clutch Release Shaft Bushing

Developed by Dennis Carpenter Ford Restoration Parts



Our all new shaft bushings are made from a lubricant fortified plastic compound which creates durable bushings that require no lubrication.

**IMPROVED DESIGN
MAINTENANCE FREE
NO LUBRICATION REQUIRED
EASIER INSTALLATION**



Proven Durability

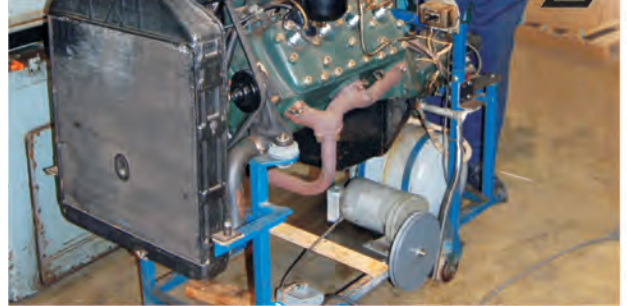

Clutch depression tested over 100,000 cycles without wear.
Never replace your clutch shaft bushing again!

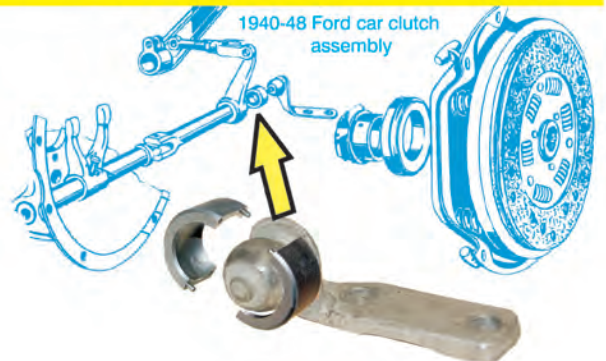

OVERDRIVE CABLE w/ Chrome Knob

PART #	PIC	NOTE	YEAR	PRICE
A9AZ-7A650-A	K	Cut to 57 1/4" long	52	49.95 ea.
A9AZ-7A650-A	K	Cut to 60 1/2" long	53-56	49.95 ea.
A9AZ-7A650-A	K	CUT TO FIT	57-59	49.95 ea.



OVERDRIVE PARTS

PART #	PIC	DESCRIPTION	NOTE	YEAR	PRICE
A9AZ-7A650-K	L	Overdrive Cable Die Cast Chrome Knob	Install w/ set screw (included)	49-59	19.95 ea.
8A-7713	M	Overdrive Cable to Steering Column Clip		49-52	4.95 ea.
1A-7001694	N	Overdrive Cable Grommet		51-59	4.95 ea.
*8A-6918-B	O	Overdrive Kick-Down Switch	Goes under accelerator pedal	49-59	24.95 ea.

K



FLYWHEEL RING GEAR

Part #	*8BA-6384
Type	8 cylinder
Note	112 Teeth
Year	1949-53
Price	39.95 ea.



OVERDRIVE WIRING

PART #	PIC	TYPE	SIZE	YEAR	PRICE
Overdrive Relay To Ignition Coil Wire					
FDT-14381-A		8 cylinder		56	9.95 ea.
FEG-14381-A		6 & 8 cylinder		57	8.95 ea.
FEG-14381-A	P	6 cylinder		58	8.95 ea.
FEY-14381-A		8 cylinder		58	8.95 ea.
Overdrive Kick Down Switch To Relay Wire					
FAA-14382-A	Q	8 cylinder	41"	52-53	34.95 ea.
B7A-14382-A	R	6 & 8 cylinder	42 3/4"	56-58	29.95 ea.
Ignition Switch To Overdrive Relay Wire					
FDR-14396-A	S	8 cylinder		56	7.95 ea.
FEG-14396-A		6 & 8 cylinder		57	7.95 ea.
FEG-14396-A		6 cylinder		58	7.95 ea.
FEU-14396-A		8 cylinder		57	7.95 ea.

FLYWHEEL RING GEAR Manual or Overdrive Transmission

Part #	EAA-6384-A
Type	
Note	- 146 teeth
Fits	272,292,312
Year	1955-59
Price	34.95 ea.



FLYWHEEL RING GEAR ASSEMBLY w/ Automatic Transmission

Part #	B8A-6375-B
Type	V8
Note	- 153 teeth - 14.96" O.D.
Fits	332,352
Year	1958-59
Price	139.95 ea.



P

Q

R

S

RADIATOR AIR DEFLECTOR SEALS



PART #	LENGTH	NOTE	PIECES	YEAR	PRICE
--------	--------	------	--------	------	-------

A Radiator Air Deflector TO HOOD SEAL

BA-8344	46" long	With Staples	(1) piece	52-54	9.95 ea.
B5A-8344	22 1/4" long	With Staples	(2) pieces	55-56	9.95 ea.

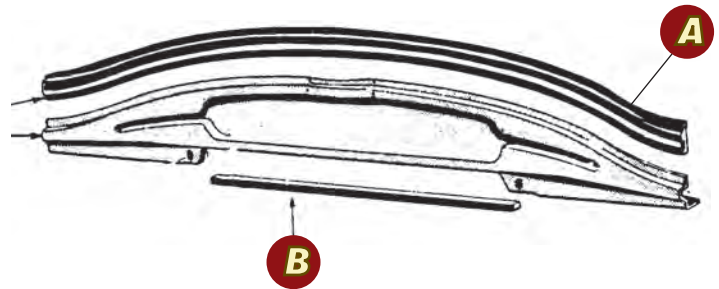

B Radiator Air Deflector TO TOP OF RADIATOR SEAL

8BA-8349	18 1/4" long			49-53	4.95 ea.
B5A-8349	20" long			55-56	5.95 ea.

GRILLE ASSEMBLY - FAIRLANE

PART #	PIC	DESCRIPTION	INCLUDES	YEAR	PRICE
B6A-8150-SET	C	Grille Assembly	Includes RH & LH, Center Cover, Hardware	1956	949.95 ea.
B6A-8221-A	D	Center Grille Strip	Chrome Plated w/ Clips	1956	169.95 ea.
B6A-8200-KIT		Grille Hardware Kit	Includes Bolts, Nuts, Shims to assemble grille halves & center bars (Included in Grille Assembly)	1956	14.95 ea.

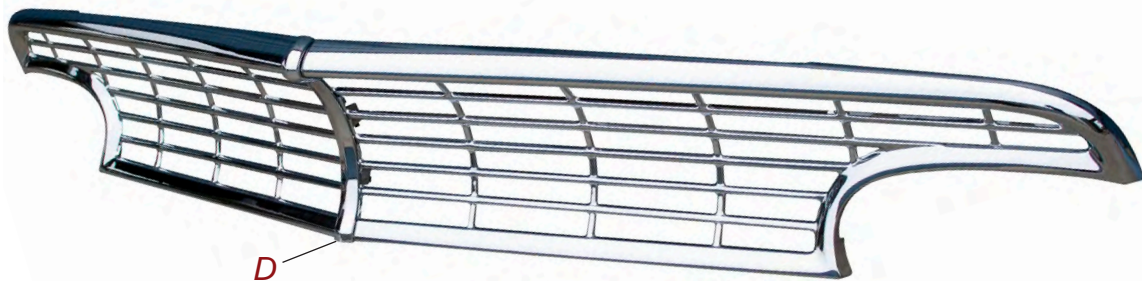

GRILLE ASSEMBLY



PART #	PIC	DESCRIPTION	DESCRIPTION	YEAR	PRICE
B5A-8200-S	E & F	Grille Assembly Kit	Complete - Includes (5) pieces	55	499.95 Kit
B5A-8206-PR	E	Parking Light Housing	RH & LH - Includes (2) pieces	55	274.95 pr.
B5A-8150-S	F	Grille Halves & Center Cover	Includes (3) pieces	55	324.95 set

**Chrome
Plated Steel**



RADIATOR CAP

PART #		YEAR	PRICE
26H-8100-R	G	49-54	11.95 ea.
C9AZ-8100-A	H	55-59	8.95 ea.



w/ 1" Deep
Filler Neck

RADIATOR DRAIN COCK

PART #	YEAR	PRICE
8A-8115	49-64	4.95 ea.



RADIATOR SIDE AIR DEFLECTOR 1952-53

PART #	SIDE	PRICE
BA-8104-B	RH	75.00 ea.
BA-8105-B	LH	75.00 ea.



NOS
Limited Supply

RADIATOR CENTER AIR DEFLECTOR 1952-53

PART #	SIDE	TYPE	PRICE
BA-8327-A	Center	8 cylinder	49.95 ea.



RADIATOR SUPPORT TO FRAME PAD

PART #	PIC	DESCRIPTION	YEAR	PRICE
8A-8125	I	Radiator Support to Frame Pad	49-53	3.95 ea.
AD-8125-B	J	Radiator Support to Frame Pad	54-56	3.95 ea.
B7A-8125-A	K	Radiator Support to Frame Pad	57-58	1.95 pr.



RADIATOR OVERFLOW HOSE

Part #	C0AZ-8081
Type	Original Ribbed Hose
Size	3 foot long
Note	May need to be trimmed
Year	1957-72
Price	4.95 ea.



RADIATOR SPLASH SHIELD PADS

Part #	BV-8210-A
Type	Mercury
Year	1955-56
Price	19.95 ea.



RADIATOR GRILLE EXTENSION MOULDING - New Old Stock

BM-8196-A	- RH
BM-8197-A	- LH
Year	1954
Price	12.00 ea.



RADIATOR GRILLE OPENING PANEL

PART #	PIC	DESCRIPTION	YEAR	PRICE
BM-8190-B		6 & 8 cylinder - 66.72" Long	54	100.00 ea.
BF-8190		6 & 8 cylinder - RH & LH	53	84.95 ea.

FRONT FENDER APRON AND RADIATOR SUPPORT

PART #	PIC	DESCRIPTION	YEAR	PRICE
AB-16138-A		NOS - Limited Supply	52-53	19.95 ea.

NEW WATER PUMPS

Narrow Belt, Gasket Included
Also fits 1952-53 Mercury

PART #	PIC	SIDE	DESCRIPTION	YEAR	PRICE
EAB-8501-N	A	RH	V8 - 239	50-53	79.95 ea.
EAB-8502-N	B	LH	V8 - 239	50-53	79.95 ea.
EAB-8501-PR		RH & LH	V8 - 239	50-53	124.95 pr.



WATER PUMPS

Gasket Included

PART #	PIC	TYPE	ENGINE	YEAR	PRICE
B6A-8501-BN	C	NEW	V-8 - 272,292,312	55-62	124.95 ea.

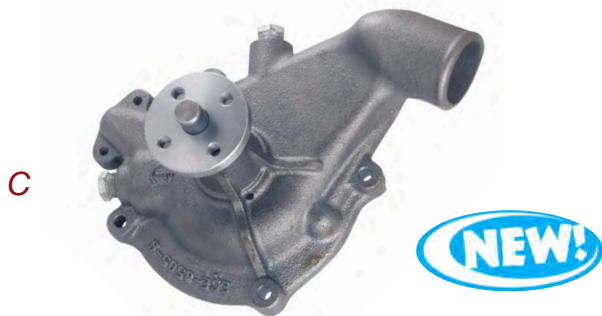

WATER PUMP BY-PASS TUBE

PART #	PIC	DESCRIPTION	YEAR	PRICE
C2TZ-8548-A	D	272,292,312	54-62	9.95 ea.
B8AZ-8597-A	E	332,352 - V8 - N.O.S.	58	10.00 ea.



WATER PUMP REPAIR KIT

PART #	PIC	DESCRIPTION	YEAR	PRICE
*A8C-8591	F	Water Pump Repair Kit - V-8 - Sleeve Bearing Type - also fits Mercury 50-53	49-53	29.95 ea.
*8BA-8507		Water Pump to Block Gasket - V-8 - Included in A8C-8591 Kit	49-53	2.95 ea.



WATER PUMP TO BLOCK BOLT KIT

Stainless - 8 bolts & lock washers

PART #	PIC	NOTE	YEAR	PRICE
8BA-8501-BOLTS	G	- Stainless - (8) bolts & (6) lock washers (Bolt inside water outlet does not need lock washer)	49-53	14.95 kit



WATER PUMP PULLEYS - V8

for 3/8" Belt

PART #	PIC	SIDE	NOTE	YEAR	PRICE
8BA-8509-B	H	RH	Flat Cast Steel	50-53	19.95 ea.
B0AZ-8509-A	I	LH	Steel Cast Concave	50-53	19.95 ea.



These features make our V8 flathead water pumps better

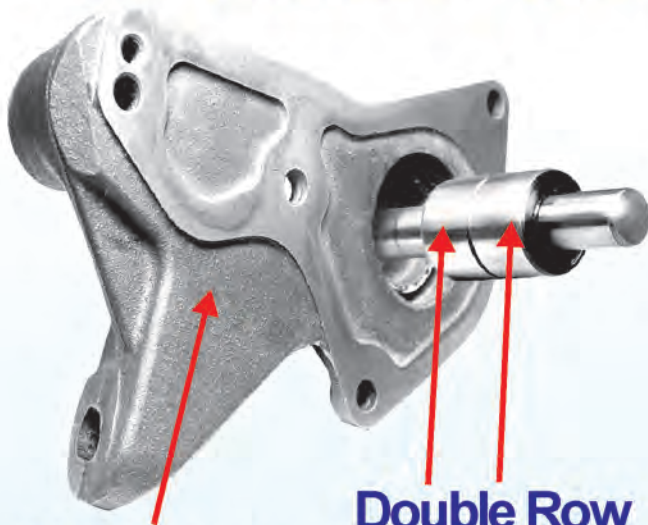

New Pump Housings

Double Row Sealed Ball Bearings

Our pump housings are new castings (not rebuilds) guaranteeing that there are no coolant-leaking stress cracks. Each housing's mounting surface is machined straight and true ensuring water-tight sealing when mounted to your flathead.

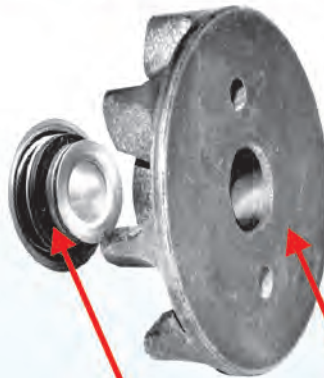

Ceramic Seals

Original impeller design creates inadequate coolant flow rate



Helical impeller design increases coolant flow rate



Helical Impellers

We've applied the advantages of modern technology to our pumps by introducing ceramic composition seals to the impeller shafts. Ceramic type seals are used in modern day water pumps and have a greater resistance to wear which significantly reduces the possibility of leakage and prolongs the life of the pumps.

We've introduced the efficiency of helical impeller blades to our 1948-1952 water pumps. The angled arrangement of the impeller blades allows the coolant to flow faster through the radiator system at lower rpms. This results in a cooler running engine when operating at idle speed.

Runs 10° Cooler

An endurance test revealed that a V8 Ford flathead fitted with a pair of our better-flowing water pumps operated with a coolant temperature averaging 155° where as the same engine using stock pumps ran at approximately 165°. This proves that our water pumps produce lower coolant temperatures at idle speed than stock pumps and can ultimately prolong the life of your V8.

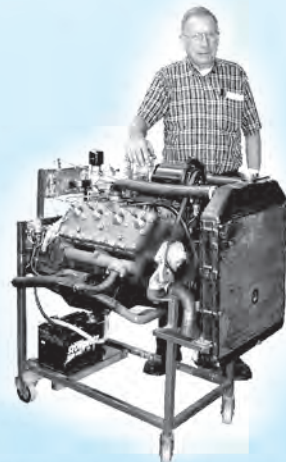

This 1940 85 h.p. flathead ran coolly for 9 continuous hours for 3 consecutive days using new Dennis Carpenter V8 water pumps.

Water Pumps Engineered To Keep Your Flathead Running Cooler

Install Dennis Carpenter water pumps on your classic Ford



UPPER RADIATOR HOSES

NON-SCRIPT - Hoses listed below are molded.

PART #	PIC	TYPE	ENGINE	YEAR	PRICE	
UPPER Radiator Hoses Non-Script						
AB-8260-A	A	Upper	6 cylinder	52-58	14.95 ea.	
B5A-8260-B	B	Upper	V-8	54-56	17.95 ea.	
B9A-8260	C	Upper	6 cylinder	59	14.95 ea.	
LOWER Radiator Hoses Non-Script						
B5A-8286-C	D	Lower	6 cylinder	52-53	17.95 ea.	
B5A-8286-C	E	Lower	6 cylinder	54-56	17.95 ea.	
B6A-8286-B	F	Lower	V-8	54-56	21.95 ea.	
B5A-8286-C	G	Lower	6 cylinder	57-59	17.95 ea.	
B6A-8286-B	H	Lower	V-8	272,292,312	57-59	21.95 ea.
B9A-8286-C	I	Lower	V-8	332,352	59	14.95 ea.

RADIATOR HOSE CLAMPS

- Original Type

PART #	PIC	TYPE	ENGINE	SIZE	YEAR	PRICE
8BA-8287	L	Upper	6 & 8 cylinder	1 5/8" OD	49-53	1.50 ea.
AB-8287	M	Upper	6 & 8 cylinder	1 7/8" OD	52-59	1.50 ea.
B-8287	N	Lower	8 cylinder	2 1/8" OD	54-59	1.50 ea.
B-8287	N	Lower	6 cylinder	2 1/8" OD	49-59	1.95 ea.
B4A-8287	O	Lower	8 cylinder	2 3/8" OD	54-59	1.50 ea.



RADIATOR HOSES - FORD SCRIPT

PART #	PIC	DESCRIPTION	YEAR	PRICE	
1BA-8260	J	Upper	V-8	49-53	34.95 pr.
8BA-8286-B	K	Lower	V-8	49-53	24.95 pr.



RADIATOR HOSE KIT

FORD SCRIPT

Part #	1BA-8285-S
Type	V-8
Note	Includes: 2 Upper Hoses 2 Lower Hoses 8 Clamps
Year	1949-53
Price	59.95 kit



THERMOSTATS

PART #	PIC	DESCRIPTION	NOTE	YEAR	PRICE
THERMOSTATS Gasket not Included					
*1BA-8575-A	P	V-8	160 degrees	49-53	5.95 ea.
C2AZ-8575-B	Q	6 cylinder	160 degrees	52-64	5.95 ea.
C2AZ-8575-B	Q	V-8	160 degrees	54-67	5.95 ea.
*1BA-8575-B	R	V-8	180 degrees	49-53	5.95 ea.
C2AZ-8575-A	S	6 cylinder	180 degrees	52-64	5.95 ea.
C2AZ-8575-A	S	V-8	180 degrees	54-67	5.95 ea.

THERMOSTAT HOUSING GASKET

*8BA-8255-B	T	V-8		49-53	2.95 ea.
B5A-8255-A	U	V-8		54-62	2.95 ea.
EAG-8255-A	V	6 cylinder		54-62	2.95 ea.
D1PZ-8255-A	W	8 cylinder	332, 352, 390	58-64	2.95 ea.

THERMOSTAT HOUSING

*8BA-8592-A	X	V-8 - Plain Steel		49-53	19.95 ea.
*8BA-8592-HR		Polished Aluminum		49-53	18.95 ea.
B5A-8592-A	Y	V-8 - 272, 292, 312		55-59	39.95 ea.



TEMPERATURE SENDER UNIT

PART #	PIC	DESCRIPTION	YEAR	PRICE
8A-10884	A	6V - (Single Terminal)	6 & 8 cylinder	40-55 44.95 ea.
8A-10990	B	6V - (Double Terminal)	8 cylinder	40-53 44.95 ea.
B6C-10884	C	12V	8 cylinder	56 49.95 ea.
B7A-10884-A	D	12V	8 cylinder	57-62 14.95 ea.

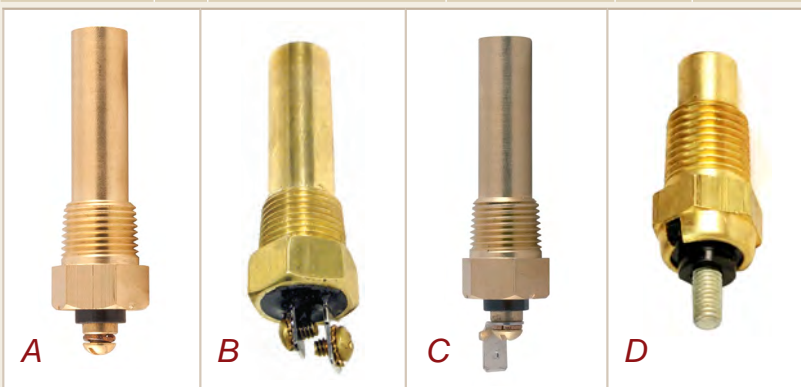

TEMPERATURE SENDER ADAPTER

PART #	PIC	DESCRIPTION	FITS	YEAR	PRICE
B4A-10911-A	E	Press in head		54-56	14.95 ea.
B7A-10911-A	F	Press in head	272,292,312	57-62	14.95 ea.

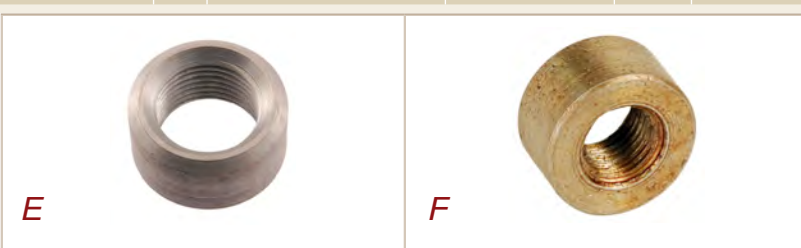

BELTS

PART #	PIC	BELT TYPE	NOTE	YEAR	PRICE
8BA-8577		Fan & Water Pump	V-8 - Narrow Type	49-53	16.95 ea.
8BA-8620-B	G	Water Pump, Generator & Fan	V-8 - Narrow Type	49-53	19.95 ea.
EAA-8620-B		Fan & Generator	6-cylinder	52-56	17.95 ea.
B8ME-8620-A		Fan & Generator	V-8	54	17.95 ea.
B6A-8620-A		Fan & Generator	V-8	55-56	16.95 ea.
C2AZ-8620-C		Fan & Generator	V-8	57	17.95 ea.
B7A-8620-A		Fan & Generator	6 cylinder	57-59	14.95 ea.
C2AZ-8620-C		Fan & Generator	V-8 - 292	58-59	17.95 ea.
EDC-8620-A		Fan & Generator	V-8 - 332,352	58-59	17.95 ea.



GAS TANK

Part #	Year
BA-9002	1952-54
Note	Must use 8A-9030 gas cap Will not accept original sending unit Includes lock ring
Fits	All except sedan delivery & wagon
Year	1952-54
Price	349.95 ea.



Part #	Year
B5A-9002-G	1955
B6A-9002-A	1956

Note	Includes lock ring
Fits	All except sedan deliver & wagon
Price	269.95 ea.



Part #	Year
B7A-9002-B	1957-58
B9A-9002-A	1959

Note	20 gallon - Steel
Fits	All except Sedan Delivery, Wagon, Retractable & Ranchero
Price	269.95 ea.



Part #	Year
B8A-9002-A	1957-59

Note	20 gallon - Steel
Fits	Ranchero, Sedan Delivery & Wagon
Price	474.95 ea.



GAS CAP

Part #	8A-9030
Note	Vented - Stainless Steel
Fits	for BA-9002
Year	1949-54
Price	7.95 ea.



Part #	AB-9030-C
Type	Non-Vented
Fits	All except S.D., SW, Retractable & Ranchero
Year	Original Tanks - 1952-59 Reproduction Tanks - 1955-59
Price	22.95 ea.



GAS TANK SLUSHING COMPOUND

GTS-9000
34.95 ea.

Sold by the Quart

Eliminates rust & seals small leaks



STAR TRON FUEL TREATMENT

3706-0033
8.95 ea.

- Treats up to 48 gallons
- Cures Ethanol (E-10) problems

Stabilizes, rejuvenates stale fuel & removes gum and varnish



GAS TANK NECK GROMMETS

PART #	PIC	DESCRIPTION	YEAR	PRICE
BA-9080-B	A	-	52-56	9.95 ea.
B7A-9080-A	B	- All ex. Retractable & Wagon	57-58	9.95 ea.
B7A-9080-B	C	- Retractable Only	57-58	24.95 ea.
B9A-9080-A	D	- Retractable Only	59	19.95 ea.



GAS FILLER NECK GROMMET

Part #	0A-9080
Type	Upper & Lower
Note	2 per car
Fits	Mercury, All except Station Wagon
Year	1951-52
Price	7.95 ea.



GAS TANK SENDING UNIT to TANK GASKET

PART #	PIC	YEAR	PRICE
*68-9276	E	36-56	2.95 ea.
B9AF-9276-A	F	57-59	1.95 ea.



GAS TANK SENDING UNIT LOCK RING

Part #	B7A-9277-A
Note	Included with gas tanks
Year	1957-59
Price	9.95 ea.



GAS TANK SENDING UNIT

w/ Float & Gasket

Part #	*99A-9275
Type	6 or 12-volt
Note	Use with Original Gauges Only
Year	1952-55
Price	39.95 ea.

Ohms Reading
- 14-18 Full
- 88-94 Empty



Part #	*B6A-9275
Type	12V
Year	1956
Price	59.95 ea.

Ohms Reading
- 75 ohms full
- 760 ohm empty



Part #	B7A-9275-F
Type	12V
Note	Use with Original Gauges Only
Fits	All except Retractable, Wagon, Ranchero

Ohms Reading
- 8-14 ohms full
- 96-104 ohms empty



Improved solid designed float & Gasket

GAS TANK SENDING UNIT FLOATS

PART #	PIC	DESCRIPTION	YEAR	PRICE
*68-9275-F	G	- Brass	ALL	14.95 ea.
*68-9275-S	H	- Plastic - Float w/ Brass End	ALL	4.95 ea.



50,000 PART NUMBERS IN STOCK!

SHOP ONLINE

www.dennis-carpenter.com

GAS TANK DOOR BUMPERS & GROMMETS

PART #	PIC	DESCRIPTION	YEAR	PRICE
--------	-----	-------------	------	-------

Gas Tank DOOR Bumpers
Fits All except Retractable, Wagon & ranchero

371347-S	A	Mounts on center of rear bumper	57-58	1.25 ea.
BA-13398-B	B	Mounts on body	52-58	4.95 ea.

Gas Tank FILLER LID Bumpers
Fits Retractable Only

0A-16378	C		57-58	2.95 pr.
----------	---	--	-------	----------

Fuel Tank Vent Pipe to Body Grommet
Fits All except Retractable, Wagon & ranchero

B5A-9069-A	D		52-59	2.95 ea.
------------	---	--	-------	----------



GAS TANK DOOR SPRING & SEAL

PART #	PIC	DESCRIPTION	YEAR	PRICE
--------	-----	-------------	------	-------

0A-16377	E	Gas Tank Filler Door Spring - Wagon & Sedan Delivery - Station Wagon - Sedan Delivery & Ranchero	52-54 57-58 59	11.95 ea.
B5A-9050	F	Fuel Tank Vent Tube Seal - All ex. Sedan Delivery, Wagon & Retractable	55-59	3.95 ea.



50,000 PART NUMBERS IN STOCK!

SHOP ONLINE

www.dennis-carpenter.com

FUEL LINES

PART #	PIC	DESCRIPTION	YEAR	PRICE
--------	-----	-------------	------	-------

Flexible Fuel Lines

1A-9288-A		Main Line to Fuel Pump	51-59	12.95 ea.
1A-9288-ANOS	G	Main Line to Fuel Pump - NOS - Ford Script	51-59	14.95 ea.

Steel Fuel Lines

91A-9369-A	H	Pump to Carb - Not Pre-Bent	49-53	4.95 ea.
8BA-9369-A		Pump to Carb - Pre-Bent - V-8	49-53	27.95 ea.



FLAT RATE SHIPPING

\$9.99 OR **\$14.99**

52-59 Ford Car

FUEL PUMP DIAPHRAM

Part #	68-9398-A
Type	- 8 cylinder - Single Action Pump
Year	1949-53
Price	14.95 ea.



ELECTRIC FUEL PUMPS

PART #	PIC	DESCRIPTION	YEAR	PRICE
EEP-9400-A	I	6 volt	52-55	59.95 ea.
EEP-9400-B	J	12 volt	56	59.95 ea.



FUEL PUMP GASKETS - V8

PART #	PIC	DESCRIPTION	YEAR	PRICE
*1GA-9417	K	Fuel Pump to Stand Gasket	49-53	0.50 ea.
*48-9374	L	Fuel Pump Stand to Manifold Gasket	32-53	1.95 ea.



FUEL PUMP ROD & ROD BUSHING - V8

PART #	PIC	DESCRIPTION	YEAR	PRICE
*8BA-9400-A	M	Push Rod	49-53	14.95 ea.
*8BA-6025	N	Push Rod Bushing	49-53	4.95 ea.



**FUEL PUMPS - NEW
- 8 CYLINDER**

PART #	PIC	DESCRIPTION	YEAR	PRICE
9785-9350	O	Glass Bowl Single Action	51-53	64.95 ea.
1BA-9350-N	P	Double Action	51-53	119.95 ea.
4206-9350	Q	Optional Equipment Fuel & Vacuum	55-58	99.95 ea.
6523-9350	R	Standard Equipment	55-60	49.95 ea.



**FUEL PUMPS - NEW
- 6 CYLINDER**

PART #	PIC	DESCRIPTION	YEAR	PRICE
4208-9350	S	Standard Equipment	55-60	79.95 ea.
4708-9350	T	Optional Equipment Fuel & Vacuum	55-60	99.95 ea.

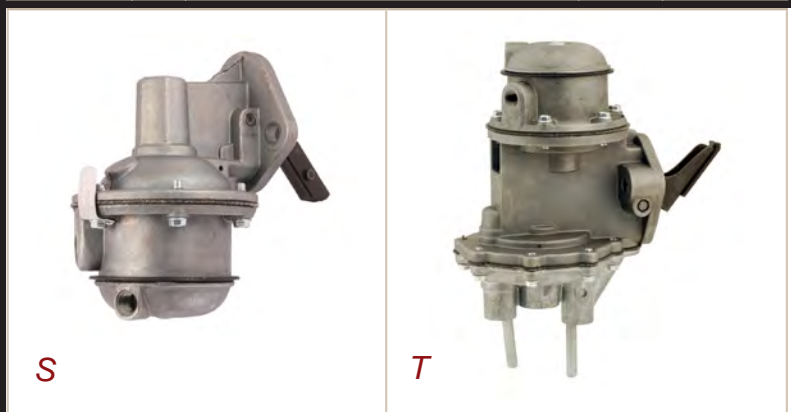

\$9.99 *or* **\$14.99** **FLAT RATE SHIPPING**
See shipping page for details.

**CARBURETOR
- for Flathead V8 Fords**

PART #	DESCRIPTION	YEAR	PRICE
<i>Carburetor includes Mounting Gasket</i>			
8BA-9510-N	Carburetor - <i>New</i> - V-8 - w/ new top & body - Made on original tooling!	49-53	294.95 ea.



Has 1949-53
Style Carburetor
Body & Top.



**Quality &
Performance
Assured**

Features of our NEW 2-Barrel Carburetors

- Choke, foot throttle and hand throttle linkages are made to original specifications for quicker and easier installation.
- Proper power valves and jet settings (#50 metering jet) to deliver reliable performance for Ford flathead V8s (engines within 85-110 h.p. range)
- Zinc Chromate exterior coating for superior resistance to corrosion. The golden coloration replicates the finish of original Ford carburetors.
- 3 hole cast iron mounting flange with gasket

**Every Carburetor is Assembled, Tested
& Calibrated at Carpenter Industries**



**CARBURETORS
- REBUILT**

PART #	PIC	DESCRIPTION	YEAR	PRICE
B4A-9510-A	B	- 2 barrel - 239 - V8 - ID - EBU	54	Outright 174.95 ea. Exchange 150.00 ea.
B5A-9510-J		- 2 barrel - ID - ECG	55	Outright 174.95 ea. Exchange 150.00 ea.
B6A-9510-R		- 2 barrel - ID - ECG - Has Automatic Choke	56	Outright 199.95 ea. Exchange 175.00 ea.



CARBURETOR THROTTLE LINKAGE KIT

Stainless Steel Rods and Stainless Steel Levers
Includes Linkage Rods & Levers

PART #	PIC	DESCRIPTION	YEAR	PRICE
59A-9584-2D	C	For 2 deuce setup	32-53	39.95 ea.
59A-9584-3D	D	For 3 deuce setup	32-53	39.95 ea.

C



D



CARBURETOR TO MANIFOLD GASKET

Part #	40-9447
Type	V-8
Year	1933-53
Price	1.95 ea.



CARBURETOR THROTTLE LINKAGE KIT with Carburetors

Rods and Levers are polished stainless steel

PART #	PIC	DESCRIPTION	YEAR	PRICE
8BA-9510-2D	E	- For (2) Carburetor Manifold - Includes (2) Carburetors & Linkage Rods & Levers		695.95 set
8BA-9510-3D	F	- For (3) Carburetor Manifold - Includes (3) Carburetors & Linkage Rods & Levers		995.95 set



CARBURETOR HEAT SHIELD & SPACER

Protects against Vapor Lock, maximize engine performance, polycore center with outer aluminum layers

PART #	PIC	TYPE	MODEL	YEAR	PRICE
SP-9447-2BYB	G	Y-Block 2 Barrell Carburetor Spacer	272, 292, 312		24.95 ea.
HS-9447-2BYB	H	Y-Block 2 Barrell Carburetor Heat Shield	272, 292, 312	F100/350	ALL 34.95 ea.
SP-9447-94	I	#94 Carburetor Spacer			ALL 24.95 ea.
HS-9447	J	#94/#97 Carburetor Heat Shield			ALL 34.95 ea.



CARBURETOR LINKAGE

PART #	PIC	DESCRIPTION	ENGINE	YEAR	PRICE
EAB-9805-A	K	Choke Lever Assembly	V8	49-53	9.95 ea.
B6A-9526-D	L	Carburetor Accelerator Pump Link	V8, 272	56	7.95 ea.
8BA-9796	M	Carburetor Choke Control Bracket	8 cylinder	49-53	11.95 ea.
B7A-9826-A		Carburetor Linkage Rod End Clip - LH	V8 & 6 Cyl.	57-70	4.95 ea.
B7A-9825-B		Carburetor Linkage Rod End Clip - RH	V8 & 6 Cyl.	57-70	4.95 ea.



CARBURETOR REPAIR KIT
8 cylinder

PART #	DESCRIPTION	YEAR	PRICE
B8A-9590-A	2 Barrell Holley	58-80	29.95 ea.
B9SZ-9A586-A	4 Barrell Carter - Model - AFB - 332, 430		39.95 ea.

CARBURETOR REPAIR KITS

PART #	PIC	TYPE	DESCRIPTION	ENGINE	MODEL	YEAR	PRICE
B2A-9590-A	A	Holley 1 Barrell	6 cylinder	215-223	1904, 1960	52-57	39.95 kit
8BA-9590	B	Holley / Stromberg 2 Barrell	8 cylinder		#94, AA-1, 2110	48-56	35.95 kit
B7A-9590-E		Holley 4 Barrell	8 cylinder	312,332,430,383	4150, 4160	57-80	39.95 kit
B6A-9590-D		Holley 4 Barrell	8 cylinder	292, 312	4000 (Teapot)	55-57	34.95 kit
C20Z-9590	C	Ford 2 Barrell	8 cylinder	289,302,352,390,427,428	2100	58-74	24.95 kit
B8A-9590-A		Holley 2 Barrell	8 cylinder	289,302,351,390,427,428	2300	58-80	29.95 kit



ACCELERATOR PEDAL ROD PARTS

PART #	PIC	DESCRIPTION	YEAR	PRICE
BA-9738-S	D	Accelerator Pedal Rod to Floor Seal	52-56	1.95 ea.
B7A-9793-A	E	Accelerator Pedal Rod to Firewall Seal	57-60	2.95 ea.
B5A-9727-A	F	Accelerator Pedal Rod Linkage	55-56	9.95 ea.
B5A-9737-B	G	Accelerator Pedal Return Spring- All Straight Drive	55	8.95 ea.



ACCELERATOR PEDAL

PART #	PIC	YEAR	PRICE
B4A-9735-A	H	52-54	14.95 ea.
B5A-9735-A	I	55-56	14.95 ea.
B7A-9735	J	57-59	14.95 ea.



50,000 PART NUMBERS IN STOCK!

SHOP ONLINE

www.dennis-carpenter.com

AIR FILTERS

PART #	PIC	DESCRIPTION	YEAR	PRICE
B7A-9601-C	K		7.18" I.D. x 9.43" O.D. x 3.47" HT	57-58 14.95 ea.
B7SZ-9601-A		292 or 312	13.69" OD x 10.81" ID x 2 1/2" HT	57 11.95 ea.



AIR CLEANER PARTS

PART #	PIC	DESCRIPTION	YEAR	PRICE
B6A-9602-SET	M	Air Cleaner Gasket Set	4 barrel	56 14.95 set
B8A-9663-A		Air Cleaner to Carburetor Brace	N.O.S. 6 cylinder	58-59 10.00 ea.
358871-S	N	Air Cleaner Wing Nut	1/4" x 20 threads	57-59 1.95 ea.



DENNIS-CARPENTER.COM
Shop Online
 Fully secure ordering - Open 24/7 - Find parts by year, description, or category.
 Weather Stripping • Die Cast Emblems • Taillight Lenses • Sheet Metal • Switches • Knobs • Upholstery • & more!
 1932-96 Ford Truck • 1932-79 Ford Cars
 1939-64 Ford Tractors • Cushman Scooters

POWERGEN GENERATOR / ALTERNATOR - 12V

PART #	PIC	DESCRIPTION	YEAR	PRICE
8A-10000-12V		12V - Manifold Mount Style - 5/8" Pulley	49-53	399.95 ea.
B6A-10000-12V	X1	12V - Swing Mount Style - 3/8" Pulley	56-64	399.95 ea.
8A-10130-PM	X2	Powergen Generator Alternator Pulley - 3/8"	49-53	39.95 ea.

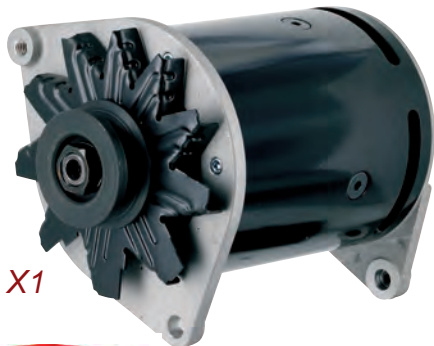

X1



X2

Use w/
8A-10000-12V
when using
belt narrow
(3/8") pulleys



- "One Wire" hook up for easy install
- Huge Amp increase stops dimming headlights
- Made from Billet Aluminum for half the weight

GENERATOR REBUILD KIT - 1956

PART #	DESCRIPTION	PRICE
B6A-10002-K	Use w/ 30 amp generator	29.95 kit

Includes:

- 1 C1TZ-10005-A.....Armature
- 1 8BA-10094.....Generator Front Bearing
- 1 C1AZ-10069-A.....Brush Set
- 1 B6A-10095-A.....Generator Rear Bearing

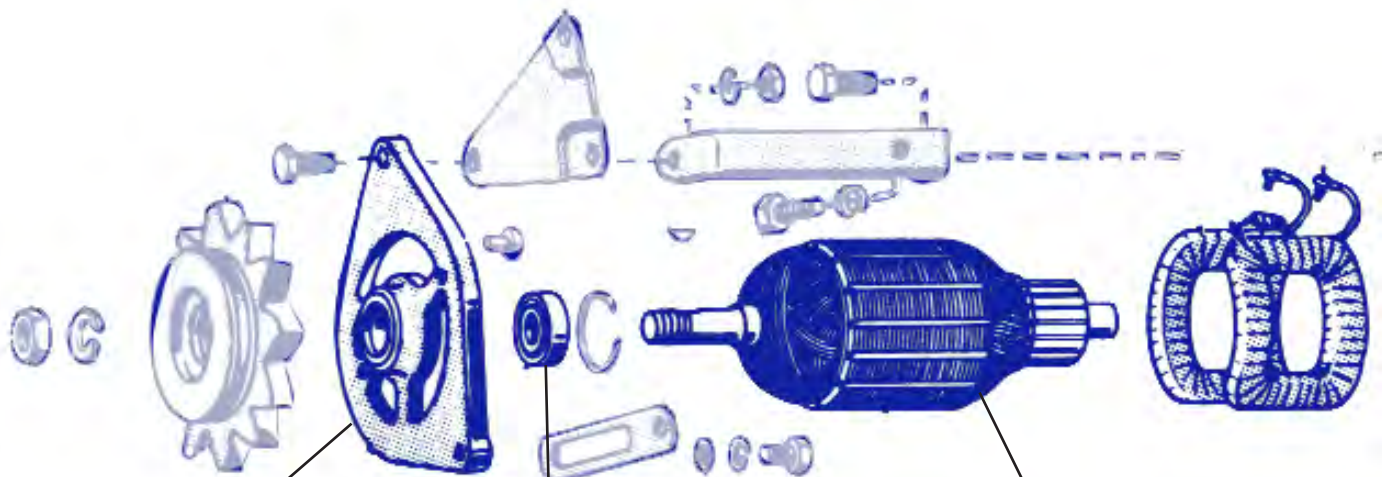

LIMITED SUPPLY NOS

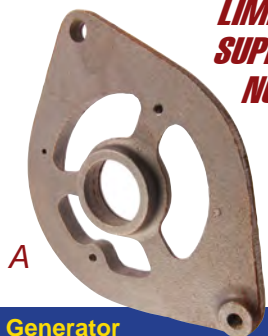

A



B



30 amp

C



Z

Generator FRONT END PLATE

PART #	YEAR	PRICE
B6A-10139-B	56-64	7.50 ea.

Generator FRONT BEARING

PART #	YEAR	PRICE
8BA-10094	40-59	5.95 ea.

Generator ARMATURE

PART #	YEAR	PRICE
*C1TZ-10005-A	56-64	24.95 ea.

Generator REAR BEARING

PART #	YEAR	PRICE
78-10128	39-53	1.95 ea.

VOLTAGE REGULATOR

PART #	PIC	DESCRIPTION	TYPE	YEAR	PRICE
51A-10505	H	Replacement	6V	49-55	49.95 ea.
B6A-10505	H	Replacement	12V	56-60	74.95 ea.



H

METAL TAGS

PART #	PIC	DESCRIPTION	YEAR	PRICE
CC-101	F	Generator	48-53	6.50 ea.
CC-102	M	Voltage Regulator	54-55	6.50 ea.



F

M

VOLTAGE REDUCER

PART #	PIC	DESCRIPTION	NOTE	PRICE
*D-10800	J	12V & 6V	For dash gauges - 1 does all 3 gauges	34.95 ea.
- reduces voltage from 12 volts to 6 volts - May need more than one - designed for 1.5 OHMS resistance at 4 AMP Maximum load.				
*U-10800	K		Good for Motors, Wipers, & Heaters.	17.50 ea.

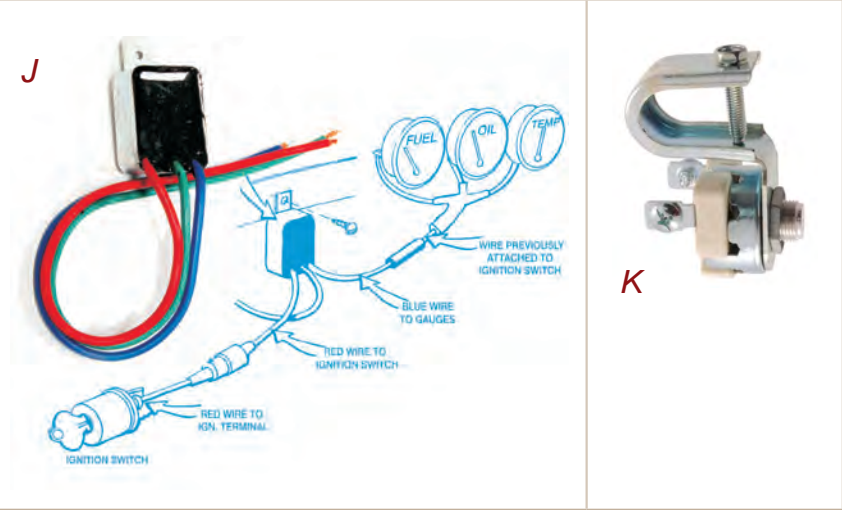

J

K

See pg. 101 for Generator to Voltage Regulator Wiring.

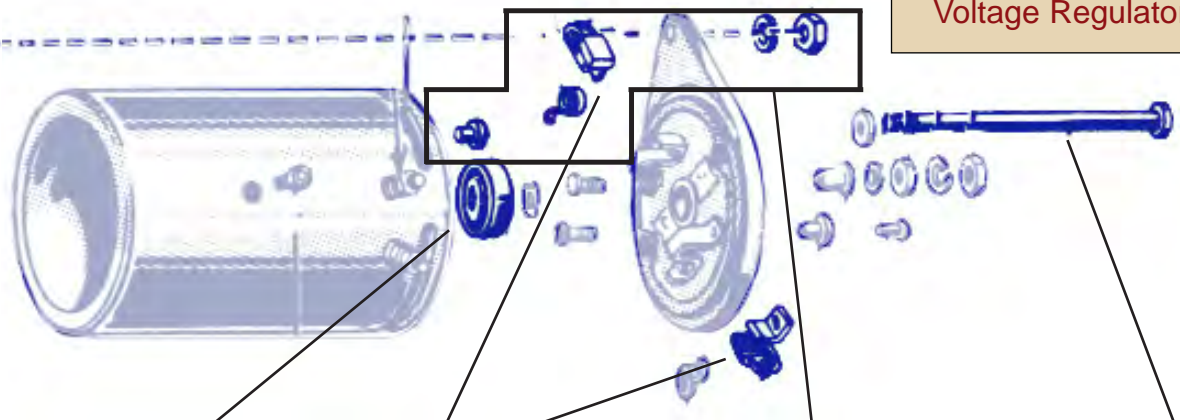

D

Generator REAR BEARING

PART #	YEAR	PRICE
B6A-10095-B	54-64	11.95 ea.

E

Generator BRUSH SET

PART #	YEAR	PRICE
01A-10069	40-59	7.95 ea.
.86" high x 1" wide x .29" thick		
C1AZ-10069-A	49-64	5.95 set
.90" high x .93" wide x .29" thick		

F

Generator REAR END PLATE & BRUSH ASSEMBLY

LIMITED SUPPLY NOS

PART #	YEAR	PRICE
C3AZ-10050-A	56-64	14.95 ea.

H

Generator / Starter STARTER BOLT

1/4" x 20 x 1" x 6 9/16"

PART #	YEAR	PRICE
*C3AZ-10120-A	54-64	3.95 ea.

BATTERY TRAY

PART #	PIC	DESCRIPTION	YEAR	PRICE
BA-5154-B	A	Battery Tray	52-53	87.50 ea.
B5A-10764-A	B	Battery Tray	55	44.95 ea.
B6A-10732-A	C	Battery Tray	56	74.95 ea.
B7A-10732-B	D	Battery Tray	57-58	94.95 ea.
C2SZ-10764-A	E	Battery Tray	59	24.95 ea.

A



B



C



D



E



Must use original mounting brackets

BATTERY HOLD DOWN BRACKET

PART #	PIC	DESCRIPTION	YEAR	PRICE
51A-5165-A	F	Heavy Metal - Exact of Original	42-53	14.95 ea.
B5A-10718-A	G		55	14.95 ea.
B6AZ-10718-B	H	14.25" x 5.50"	56	19.95 ea.
B7A-10718-A	I	5-5/8"X1 2-5/8	56-58	27.95 ea.
B7A-10718-R	J	Correct for 29N Battery	57-58	34.95 ea.

F



G



H



I



J



ENGINE TO DASH GROUND WIRE

Part #	14303-AR
Year	1955-64
Price	3.95 ea.



Engine Ground Strap (to body or frame) 12 Wire Mesh - Universal

Part #	D1PZ-14303-A
Year	ALL
Price	9.95 ea.



BATTERY HOLD DOWN CLAMP KIT

Part #	8M-5175-B
Type	3-3/4" bolts
Note	Includes: (2) Nuts (2) Rubber Washers (2) Metal Washers (2) Bolts
Year	1949-53
Price	9.95 kit

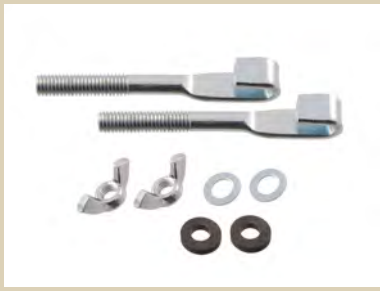

Part #	8M-5175-AS
Type	5-1/4" bolts
Note	Includes: (2) Nuts (2) Rubber Washers (2) Metal Washers (2) Bolts
Year	1949-54
Price	9.95 kit



Part #	B7A-5175-S
Note	Includes: (2) nuts (2) rubber washers (2) metal washer (2) bolts
Year	1957-58
Price	7.95 kit



BATTERY HOLD DOWN NUT & WASHER

Part #	B6A-5179-S
Type	5/16"
Note	9 pieces Kit for 3 bolts
Year	1955-56
Price	3.95 kit



BATTERY TENDER

PART #	DESCRIPTION	PRICE
10654-612	- Selectable 6V or 12V w/ slide switch - 0.9 amps - will work w/ STD, Gel & AGM Type Batteries	44.95 ea.



STARTER BUTTON

Part #	2C-11500
Year	1952-55
Price	17.50 ea.



IGNITION SWITCH & CYLINDER ASSEMBLY

PART #	PIC	DESCRIPTION	YEAR	PRICE
B5A-11572-A	K	Ignition Switch Housing Assy Only	52-59	17.95 ea.
BA-11582-A	L	Ignition Cylinder Assembly w/ Key	52-59	9.95 ea.
*FAA-11572-A		Ignition Switch Housing	52-54	29.95 ea.
B6A-11585-A		Ignition Switch Retainer Nut	52-56	14.95 ea.



STARTER RING GEAR
For Fordomatic Transmission

PART #	PIC	DESCRIPTION	TEETH	YEAR	PRICE
1P-7950-E	M	All 6 & 8 cylinder	146 teeth	54	39.95 ea.
1P-7950-E	M	6 cylinder		55-59	39.95 ea.



STARTER TAG

Part #	CC-103
Year	1948-55
Price	6.50 ea.

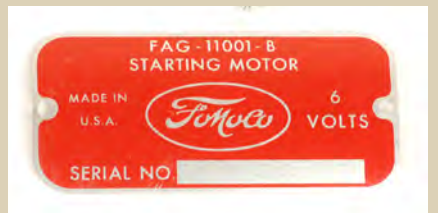

STARTER 12V HI-TORQUE RETRO "Same on the Outside - Better on the inside"



PART #	PIC	DESCRIPTION	TYPE	NOTE	YEAR	PRICE
B4A-11002-YBP	A	Y Block	V8 239,272,292,312		54-64	199.95 ea.
B6A-11002-SBA	B	Small Block	V8	157 teeth flywheel - 3/4" depth	56-64	249.95 ea.
B6A-11002-SBB		Small Block	V8	164 teeth flywheel - 3/8" depth	56-64	249.95 ea.
B6A-11002-BBA	C	Big Block	V8 352,390,427,428	184 teeth flywheel	58-up	249.95 ea.



Stronger • Faster • More Durable • More Reliable

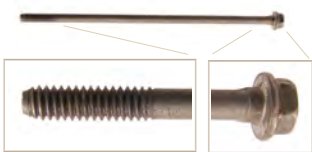
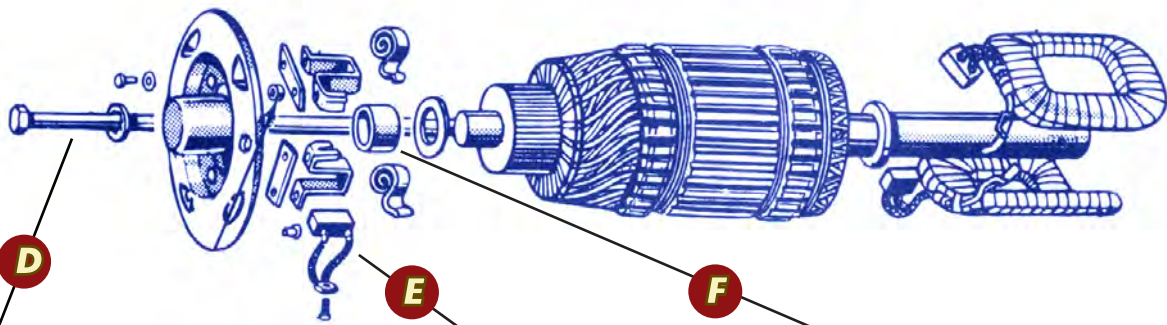

1/4" x 20 x 1" x 6 9/16"

Generator / Starter STARTER BOLT

PART #	YEAR	PRICE
*C3AZ-10120-A	54-64	3.95 ea.



Starter SUPPORT BRACKET

Rear of Starter to Oil Pan

PART #	TYPE	YEAR	PRICE
*51A-11140	- V8 - 6 cyl	39-53 41-53	7.95 ea.



Starter BRUSHES - (4)

PART #	YEAR	PRICE
*18-11057	60-64	9.95 set

Starter PLATE BUSHINGS

PART #	*18-11052
TYPE	Brush End
YEAR	60-64
PRICE	1.95 ea.
PART #	1CM-11135-A
TYPE	Drive End
YEAR	60-64
PRICE	2.95 ea.



5/8"IDx13/16"ODx1 5/32"L

STARTER ASSEMBLY

Replacement Type

• With Modern Bendix • No Core Required

PART #	PIC	DESCRIPTION	YEAR	PRICE
18-11002-N6V	K	6 volt	32-53	179.95 ea.
18-11002-N12V	L	12 volt	32-53	179.95 ea.



STARTER to FLYWHEEL HOUSING RUBBER SEAL

Part #	*C2AZ-6436-A
Type	8 cylinder 239,272,292,312
Year	1954-62
Price	11.95 ea.



STARTER SOLENOID

PART #	PIC	DESCRIPTION	YEAR	PRICE
FAB-11450-B	M	6-volt	52-55	24.95 ea.
B6A-11450-A	N	12-volt	56-64	14.95 ea.

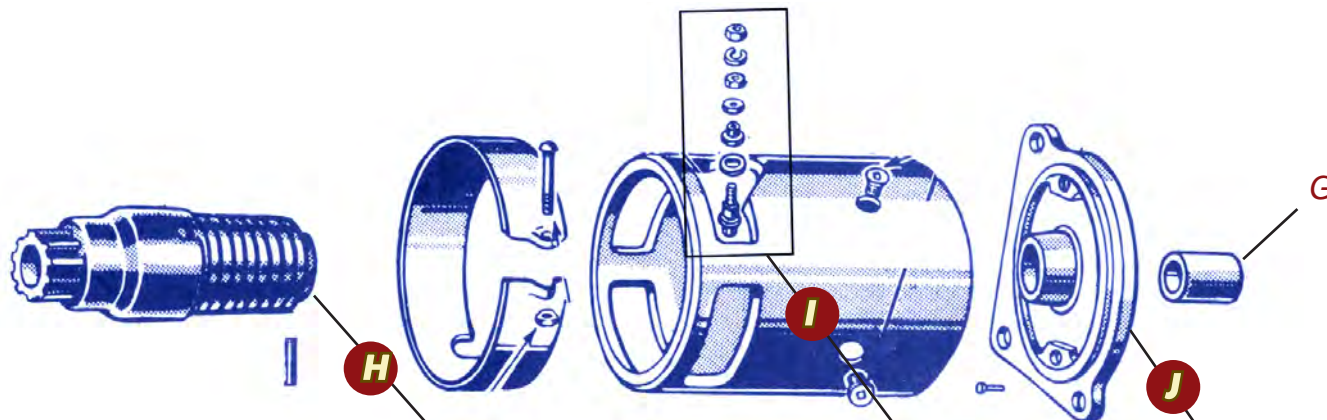

Starter DRIVE H

PART #	PIC	DESCRIPTION	YEAR	PRICE
B-11350		Starter Drive - New - V-8	32-53	29.95 ea.
C1AZ-11350-A		Starter Drive or Bendix	57-59	57.50 ea.
B-11375		Starter Drive Spring	32-53	7.95 ea.

Starter POST KIT I

PART #	YEAR	PRICE
*A9AZ-11102-B	60-64	5.95 kit

Starter DRIVE END PLATE & BUSHING J

PART #	PRICE
C2AZ-11130-A	14.95 ea.
- All 8 cyl.	60-62
- All ex. 260, 289, 430	63-64

**DISTRIBUTOR
- INTERNAL**

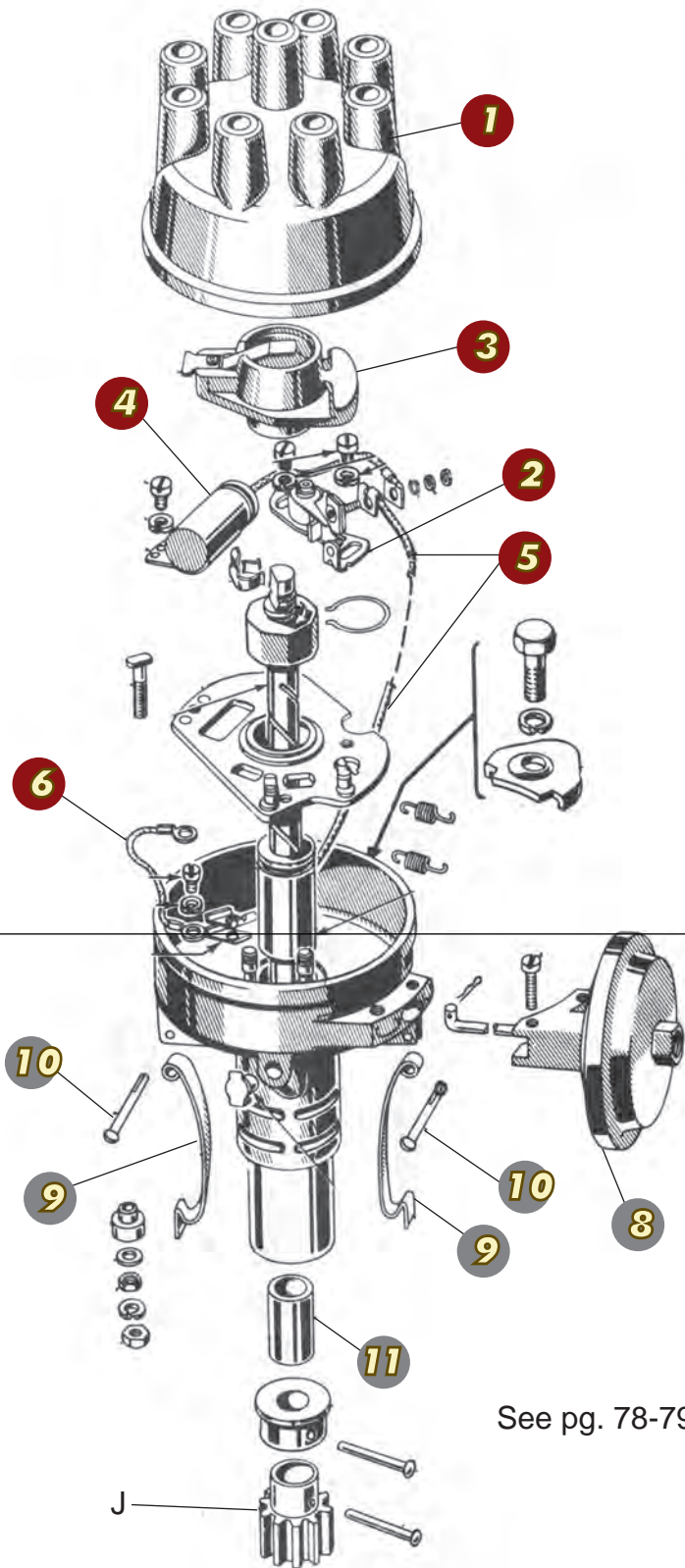

See pg. 78-79

**DISTRIBUTOR
- HOUSING.....see pg. 78-79**

1 DISTRIBUTOR CAP

PART #	PIC	DESCRIPTION	YEAR	PRICE
7HA-12106	A	6 cyl.	49-64	12.95 ea.
FAB-12106-A	B	8 cyl.	49-56	19.95 ea.
B7A-12106	C	8 cyl. - Grey	57-64	9.95 ea.
B7A-12106-BL	D	8 cyl. - Black	57-72	9.95 ea.
C9AZ-12106		8 cyl. - Black - Autolite Script	57-72	24.95 ea.



2 IGNITION POINTS

PART #	PIC	DESCRIPTION	YEAR	PRICE
FAA-12171-A	E	8 cylinder - All	49-53	5.95 ea.
FAA-12171-A	E	6 cylinder - All	49-64	5.95 ea.
FAB-12171-A	F	8 cylinder - All	54-56	7.95 ea.
B8Q-12171-A	G	8 cylinder - All	57-74	3.95 ea.



3 IGNITION ROTOR

PART #	PIC	TYPE	YEAR	PRICE
FAA-12200-B	H	6 cylinder	46-64	2.95 ea.
FAA-12200-B	H	8 cylinder	46-56	2.95 ea.
B7A-12200	I	8 cylinder	57-64	4.95 ea.



4 IGNITION CONDENSORS

Part #	FAB-12300-A
Style	Replacement Style
Type	8-cylinder
Year	1954-56
Price	5.95 ea.



Part #	FAB-12300-R
Style	Original Style
Type	V-8 - Y-Block
Note	w/ wrap around mounting bracket
Year	1954-56
Price	4.95 ea.

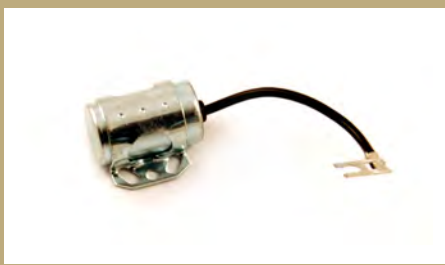

Part #	B9AZ-12300-A
Style	Replacement Style
Type	8-cylinder
Note	w/ soldered mounting bracket
Year	1957-59
Price	5.95 ea.



IGNITION TUNE-UP KIT

Includes Points, Condensior, & Rotor

PART #	DESCRIPTION	YEAR	PRICE
A7A-12000-B	6-cylinder	48-64	9.95 kit
A7A-12000-B	8-cylinder	49-53	9.95 kit



5 DISTRIBUTOR PRIMARY LEAD WIRE

PART #	PIC	DESCRIPTION	YEAR	PRICE
7HA-12216	F	8 cylinder	49-56	17.95 ea.
CODF-12216-A	G	8 cylinder	57-74	17.95 ea.
C5TZ-12216-A	H	6 cylinder	49-72	4.95 ea.



6 DISTRIBUTOR GROUND WIRE

Part #	7RA-12264
Year	6 cylinder - 1949-64 8 cylinder - 1949-56
Price	3.95 ea.



DISTRIBUTOR SHAFT & CAM ASSEMBLY

Part #	B7A-12175-A
Year	1957-59
Price	19.95 ea.



DISTRIBUTOR SHAFT ROTOR BUTTON SPRING

Part #	OBA-12213
Type	8 cylinder
Year	1948-56
Price	6.95 ea.



DISTRIBUTOR

- INTERNAL.....see pg. 76-77

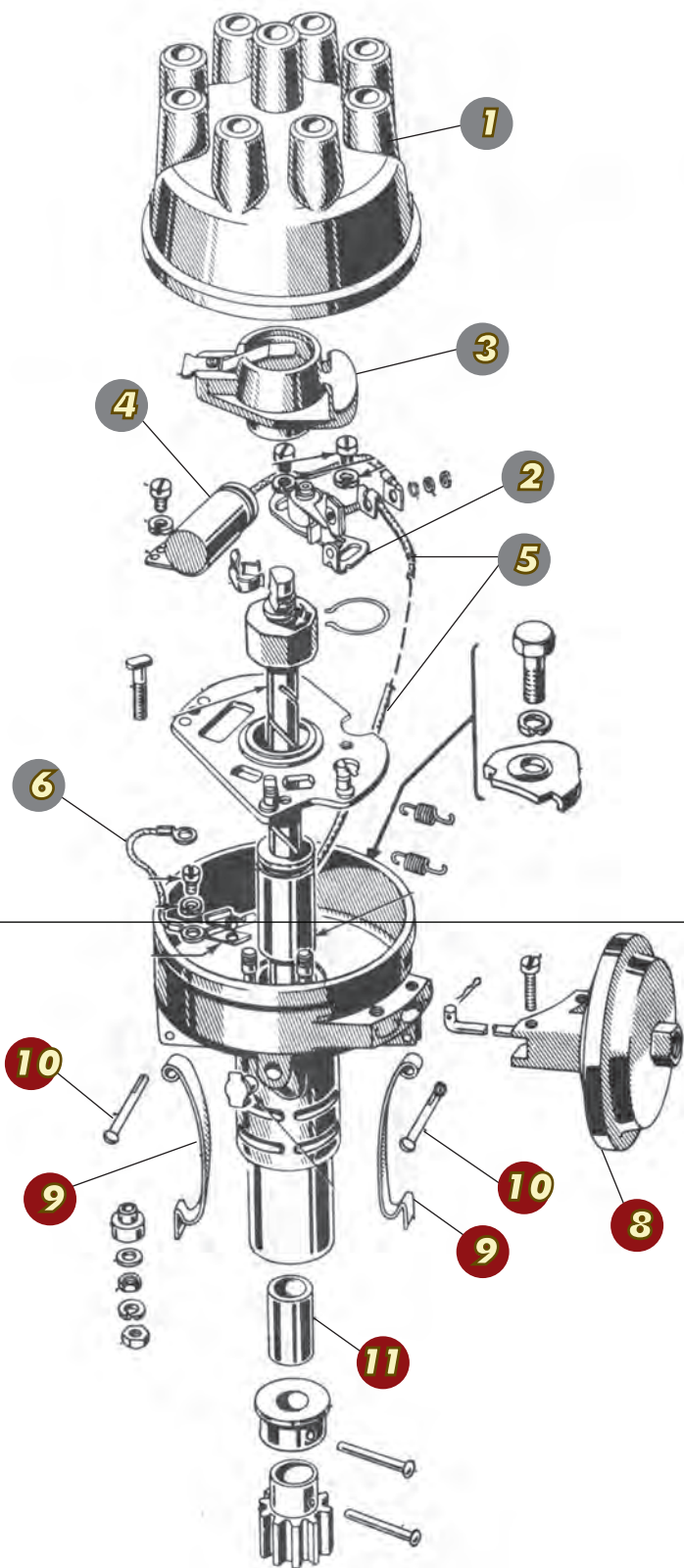

DISTRIBUTOR
- HOUSING

DISTRIBUTOR ASSEMBLY - REBUILT

Includes Points, Condensor, Bushings & Vacuum

PART #	PIC	DESCRIPTION	YEAR	PRICE
CAST IRON Distributor Assembly				
7RA-12127-R		Outright	49-53	199.95 ea.
7RA-12127-R		Exchange	49-53	100.00 ea.
ALUMINUM HOUSING Distributor Assembly				
8BA-12127-R		Outright	49-53	199.95 ea.
8BA-12127-R		Exchange	49-53	100.00 ea.



IGNITION COIL

PART #	PIC	DESCRIPTION	YEAR	PRICE
8BA-12029	A	6-volt	49-55	29.95 ea.
B6A-12029	B	12-volt	56-58	22.50 ea.
B6AZ-12029	C	12 volt - "Mustard Top"	56-74	39.95 ea.



A



B



C

IGNITION COIL BRACKET - ORIGINAL TYPE

PART #	PIC	DESCRIPTION	YEAR	PRICE
*8BA-12043		Coil Bracket - Original Type	48-53	14.95 ea.
B5A-12044-A		Coil Bracket - Original Type (Correct for 1955 - Replacement for 1954 & 1956-62.)	55	5.95 ea.

8 DISTRIBUTOR VACUUM ADVANCE

PART #	PIC	DESCRIPTION	YEAR	PRICE
7RA-12370-B	D	6 cylinder	49-56	24.95 ea.
7RA-12370-B	D	8 cylinder	49-53	24.95 ea.
B9AF-12370-A	F	8 cylinder	57-59	35.95 ea.



D

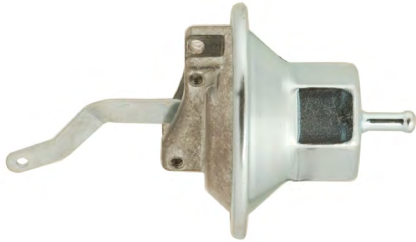

F

9 DISTRIBUTOR TO CAP HOLD DOWN CLAMP

Part #	7RA-12144	
Type	6 & 8 cylinder	
Note	2 per distributor	
Year	1949-56	
Price	3.95 ea.	

10 DISTRIBUTOR CAP CLIP RIVOT

Part #	B-12145	
Year	6 cylinder - 1946-64 8 cylinder - 1942-64	
Price	0.95 ea.	

DISTRIBUTOR TO COIL WIRE

Part #	7RA-14302
Year	V8 - 1948-53
Price	4.95 ea.



11 LOWER DISTRIBUTOR BUSHING

Part #	*7RA-12132-A
Type	6 & 8 cylinder
Note	.470" ID, .596 OD, .88 Long
Year	1949-53
Price	4.95 ea.



SPARK PLUG WIRES

PART #	PIC	DESCRIPTION	TYPE	ENGINE	YEAR	PRICE
8BA-12259-S	A	Original type	Steel Core		49-53	54.95 set
1A-12259	B	Original type - Ford Script	Steel Core	V-8-239 Flathead	49-53	79.95 set
B5A-12259	C	Original type	Steel Core	V-8-239,272,292,312	54-62	94.95 set
D1AZ-12259-F	D	Motorcraft	Graphite Core	8-cyl. - 272, 292, 312	54-59	59.95 set
C5AZ-12259-F	E			8 cyl. - 352	58-64	59.95 set



SPARK PLUGS

Part #	7RA-12405
Type	844 Autolite
Note	Gap Setting .029/.033
Year	1940-53
Price	2.50 ea.
Part #	7RA-12405-H10
Type	Champion
Fits	H-10 Gap Setting .029/.033
Year	1940-53
Price	3.50 ea.
Part #	B5C-12405-A
Type	Champion
Fits	18MM
Year	1955-57
Price	3.50 ea.
Part #	B7A-12405-A
Type	Motorcraft
Fits	BSF-6 for use with 6 cylinder
Year	1955-64
Price	2.95 ea.



SPARK PLUG WIRE MOUNTING BRACKETS

Part #	FAA-12111-2K
Fits	239,272,292,312
Year	1955-64
Price	24.95 ea.



SPARK PLUG WIRE MOUNTING GROMMET

Part #	FAA-12297-K
Fits	239, 272, 292, 312
Note	Rubber, Set of 6
Year	1954-64
Price	14.95 ea.



SPARK PLUG METAL SHIELD

Part #	B5A-12299-A
Fits	8 cylinder
Note	Need (4) per car
Year	1955-57
Price	5.95 ea.

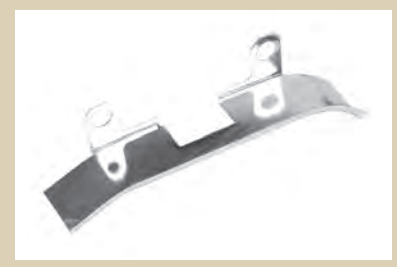

SPARK PLUG WIRE SEPARATION KIT

Part #	B6A-12297-K
Fits	V8
Note	4 pcs. kit
Year	1958-up
Price	5.95 ea.



50,000 PART NUMBERS IN STOCK!

SHOP ONLINE

www.dennis-carpenter.com



**SOLID STATE ELECTRONIC
IGNITION SYSTEM - 8 cyl. - 12V only**

Replaces points & condensor

PART #	PIC	DESCRIPTION	YEAR	PRICE
8BA-12000-1283P6		6V Positive Ground	49-53	119.95 ea.
8BA-12000-1283		12V Negative Ground	49-53	109.95 ea.
B4A-12000-1282	F	272 & 292	54-56	99.95 ea.
B7A-12000-1281	G	All ex. with dual points	57-74	99.95 ea.



**Carpenter
NEWSLETTER**

Sign up at Dennis-Carpenter.com.

Latest Car Show Information • New Products
Customer Testimonials • Online Catalogs • Sales
Discounts • Promotions • News & Updates

*Get on the mailing list...
Today!*



For Orders Only: 1-800-476-9653
Shop Online at DENNIS-CARPENTER.COM

HEADLIGHT BULB RETAINER RING

PART #	PIC	DESCRIPTION	YEAR	PRICE
01A-13018-C	A	Stainless Steel - Replacement	40-57	10.95 ea.
01A-13018-SS	B	Stainless Steel	40-57	14.95 ea.



HEADLIGHT BUCKET TO FENDER GASKET

PART #	PIC	DESCRIPTION	YEAR	PRICE
11A-13044	D		52-56	3.95 ea.
B7A-13044-A	E		57	3.95 ea.
B8A-13044-A	F		58	4.95 ea.

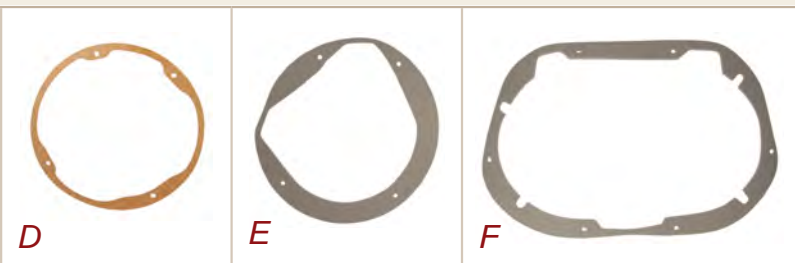

HEADLIGHT SPRING

PART #	PIC	DESCRIPTION	YEAR	PRICE
11A-13031	G	Headlight Bucket Spring	41-56	1.95 ea.
FAA-13067-A	H	Inside Headlight Ring Spring Retainer - Set of (6)	52-53	5.95 set



HEADLIGHT BULBS

PART #	PIC	DESCRIPTION	YEAR	PRICE
B5A-13007-H		Halogen - 6V	40-55	14.95 ea.
B6A-13007-H		Halogen - 12V	56-57	15.95 ea.
C0DZ-13007-A		Halogen - 12V - FoMoCo Script	56-57	19.95 ea.
B6A-13007		6014 - 12-volt	56-57	11.95 ea.
B8AZ-13007-A	C	Low Beam - Outer	58-64	9.95 ea.
B8A-13007-A		Halogen - Low Beam - Outer 12V w/ FoMoCo Script	58-64	19.95 ea.
B8AZ-13007-B		High Beam - Inner	58-64	9.95 ea.
B8A-13007-B		Halogen - High Beam - Low 12V w/FoMoCo script	58-64	19.95 ea.



HEADLIGHT HIGH BEAM INDICATOR BULBS

PART #	PIC	DESCRIPTION	YEAR	PRICE
48-15021-51	I	6 volt	49-51	1.50 ea.
78-13466-55	J	6 volt	52-55	1.50 ea.
B6A-13466-57	K	12 volt	56-57	0.95 ea.

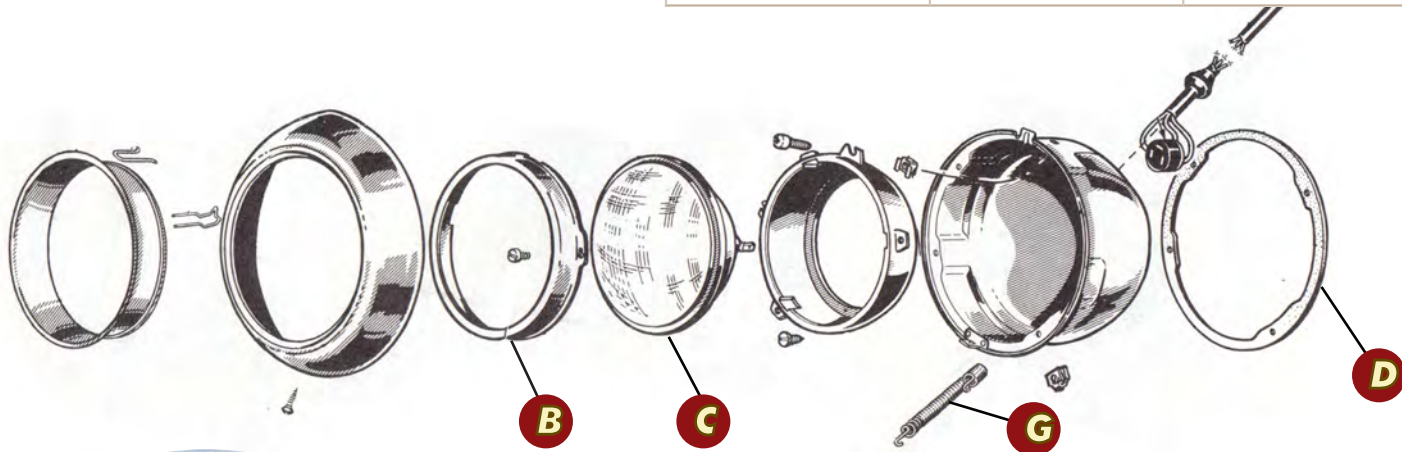

HEADLIGHT BUCKET SOCKET & WIRING

PART #	PIC	DESCRIPTION	YEAR	PRICE
0A-13076	L	RH or LH	49-54	24.95 ea.
B5A-13076-A	M	RH or LH	55-56	17.95 ea.
B7A-13076	N	RH	57	34.95 ea.
B7A-13077		LH	57	29.95 ea.
B9AF-13076-A	O	RH or LH	59	39.95 ea.

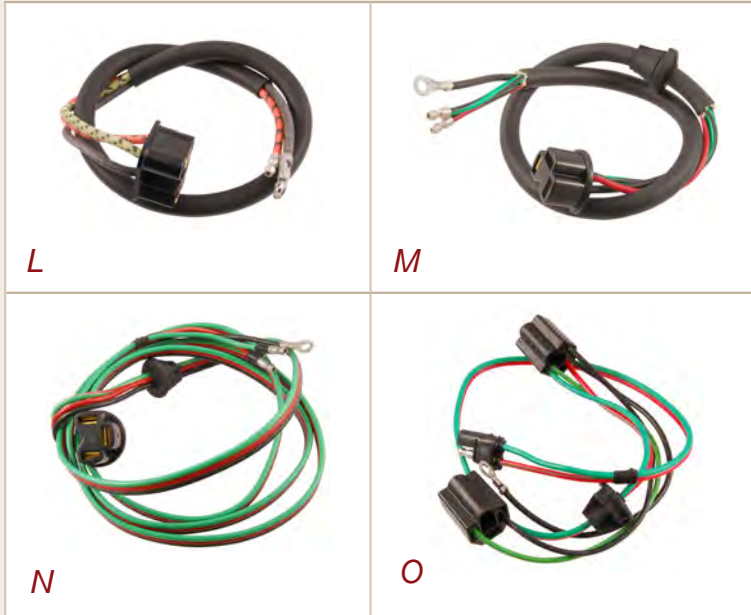

HEADLIGHT TRIM

PART #	PIC	DESCRIPTION	YEAR	PRICE
*B5A-13063-K	P	Headlight Trim (Eyebrow) - Fairlane	55	199.95 pr.
B8A-13063-A		Headlight Trim - N.O.S. - RH	58	50.00 ea.



HEADLIGHT DOOR MOULDING "END"

PART #	PIC	DESCRIPTION	YEAR	PRICE
B6A-13011-PR		Headlight Door Top Molding Trim - Fairlane	56	39.95 pr.



HEADLIGHT RIM SCREWS

1 screw per rim
Sold in sets of (2)



PART #	TYPE	YEAR	PRICE
BA-13048-S	Stainless	1952	0.95 set
BF-13048-S	Stainless	1953	0.95 set
B4A-13048-S	Stainless	1954	0.95 set
B5A-13048-S	Black	1955	0.95 set
B6A-13048-S	Black	1956	0.95 set
B7A-13048-S	Stainless	1957	0.95 set
B8A-13048-S	Stainless	1958	0.95 set
B9A-13048-S	Stainless	1959	0.95 set

HEADLIGHT DOOR SCREWS CLIPS

2 per headlight

Part #	B5A-13098-A
Year	1955-56
Price	1.95 ea.



HEADLIGHT BUCKET SCREWS

Includes all fasteners for (1) headlight assembly & screws for bulb retainer ring.

PART #	YEAR	PRICE
BA-13050-S	1952	6.95 set
BF-13050-S	1953	6.95 set
B4A-13050-S	1954	6.95 set
B5A-13050-S	1955	6.95 set
B6A-13050-S	1956	6.95 set
B7A-13050-S	1957	7.95 kit
B8A-13050-S	1958	7.95 kit
B9A-13050-S	1959	7.95 kit



HEADLIGHT CROSSOVER WIRE

PART #	PIC	DESCRIPTION	YEAR	PRICE
FAA-14445-B	Q	w/ Turn Signals	52	29.95 ea.
FAA-14445-F		w/ Turn Signals	53	49.95 ea.
FDA-14445-B	R	w/ Turn Signals	54	49.95 ea.
B5A-14445-B			55	62.95 ea.
B6A-14445-A			56	62.95 ea.
FAA-116653-A	S	Mercury	52-53	29.95 ea.
FDC-14445-A	T	Mercury w/ Turn Signals	54	39.95 ea.



HEADLIGHT SWITCH

PART #	PIC	DESCRIPTION	NOTE	YEAR	PRICE
FAA-11654-A	A	6V	No Knob	50-54	44.95 ea.
B5T-11654-A	B	6V	No Knob	55	49.95 ea.
B6T-11654-A	C	12V	No Knob	56-57	44.95 ea.
B9AF-11654-A	D	12V	No Knob	58-59	49.95 ea.

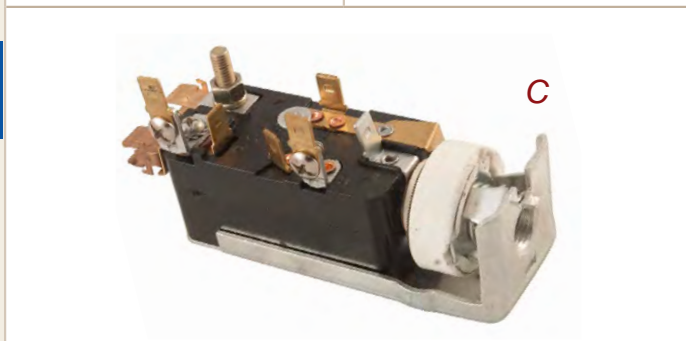
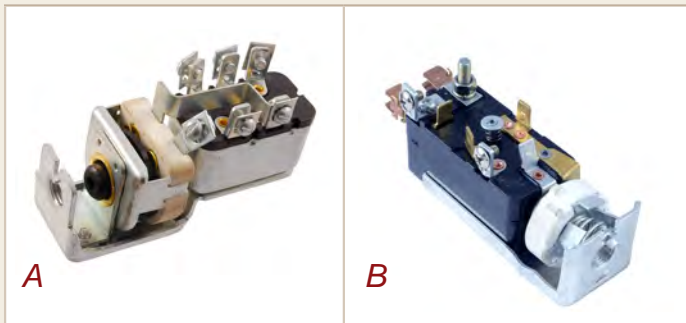

\$9.99 *or* **\$14.99** **FLAT RATE SHIPPING**
See shipping page for details.

Headlight DIMMER SWITCH & PAD

PART #	PIC	DESCRIPTION	YEAR	PRICE
8A-13532	E	Head Light Dimmer Switch	49-56	19.95 ea.
B7A-13532	F	Head Light Dimmer Switch	57-58	22.95 ea.
B9A-13532-A	G	Head Light Dimmer Switch	59-72	10.95 ea.
C5ZZ-13533	H	Dimmer Switch Rubber Cover Pad	All	3.95 ea.



PARK LIGHT - 1952

PART #	PIC	DESCRIPTION	NOTE	YEAR	PRICE
FAA-13208-B	A	Lens	Plastic	1952	15.95 ea.
BA-13238-S	B	Lens Screws	Replacement	1952	3.95 set
FAA-13211	C	Gaskets		1952	5.95 pr.

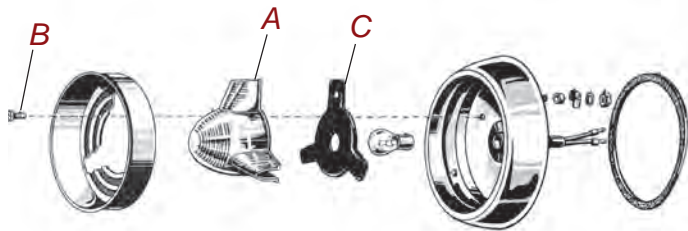

PARK LIGHT - 1953

PART #	PIC	DESCRIPTION	NOTE	YEAR	PRICE
FAF-13208-A	D	Lens	Plastic	1953	5.95 ea.
BF-13238-S	E	Lens Screws	Replacement	1953	1.95 set
FAF-13211-A	F	Gaskets		1953	5.95 pr.

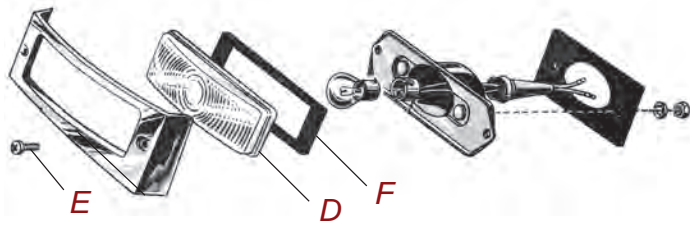

PARK LIGHT - 1954

PART #	PIC	DESCRIPTION	NOTE	YEAR	PRICE
FAG-13208	G	Lens		1954	9.95 ea.
B4A-13238-S	H	Lens Screws	Replacement	1954	2.50 set
B4AZ-13210-A	I	Door		1954	17.50 ea.
FAG-13211-A	J	Gasket		1954	5.95 pr.

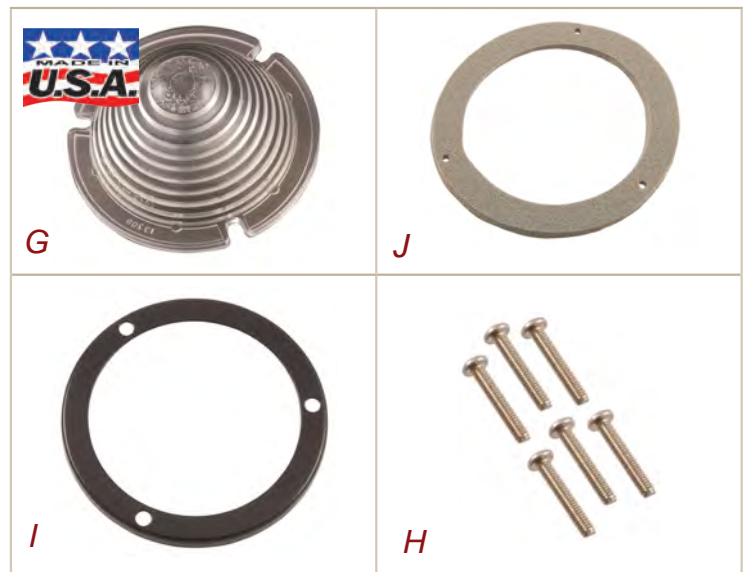
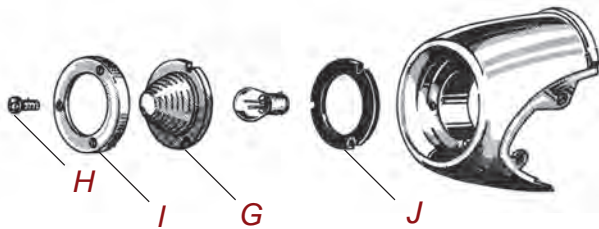

PARK LIGHT - 1955

PART #	PIC	DESCRIPTION		YEAR	PRICE
B5A-13208-B	K	Lens		1955	29.95 ea.
B5A-13238-S	L	Lens Screws	Replacement	1955	3.95 set
B5A-13211-A	M	Gasket		1955	5.95 pr.
B5A-8206-PR	N	Housing	RH & LH	1955	274.95 pr.

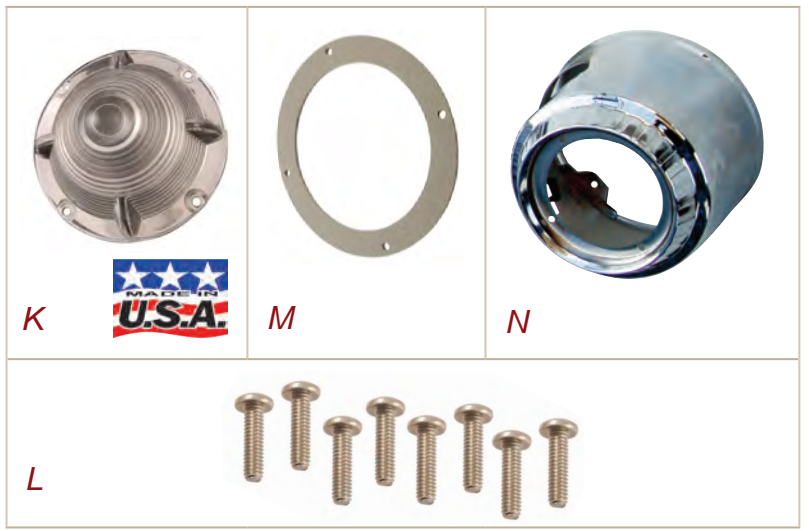
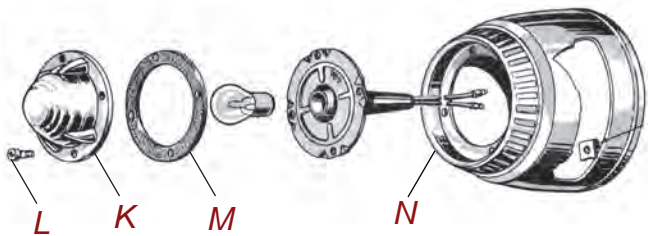

PARK LIGHT - 1956

PART #	PIC	DESCRIPTION	NOTE	YEAR	PRICE
B6A-8206-PR	O	Housings	Sold as pair	1956	599.95 pr.
B6A-13208	P	Lens		1956	14.95 ea.
B6A-13211-A	Q	Gasket		1956	5.95 pr.
B6A-13238-S	R	Lens Screws	Replacement	1956	1.95 set

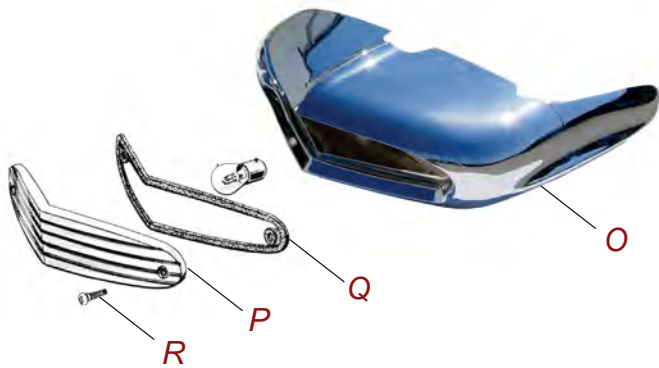

PARK LIGHT PARTS - 1957

PART #	PIC	TYPE	NOTE	YEAR	PRICE
B7A-13206-A	S	Body	Right or Left	1957	23.95 ea.
B7A-13208	T	Lens	Right or Left	1957	16.50 ea.
B7A-13211-A	U	Gaskets		1957	5.95 pr.
B7A-13238-S	V	Lens Screws		1957	1.95 set

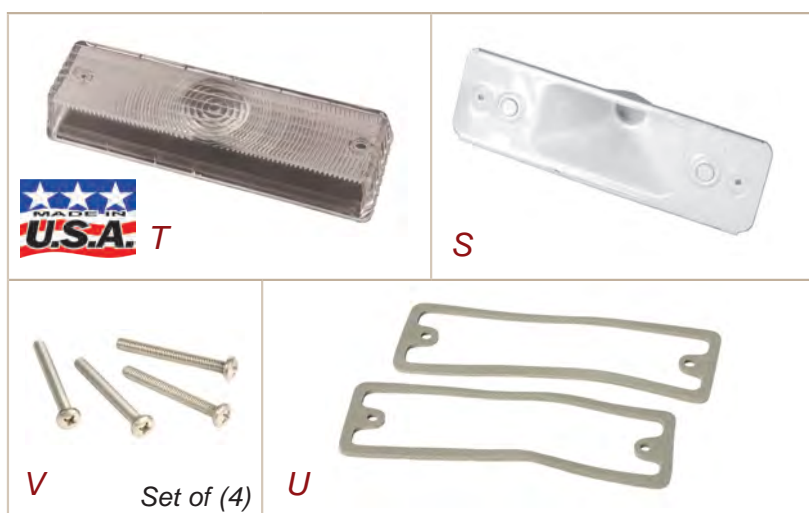
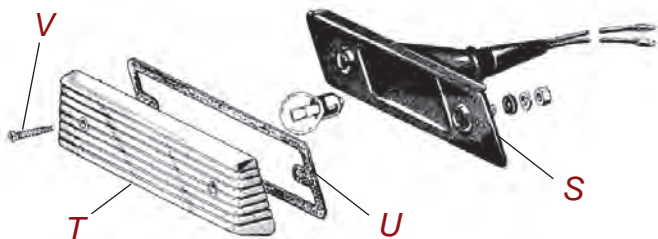

PARK LIGHT PARTS - 1958

PART #	PIC	TYPE	NOTE	YEAR	PRICE
B8A-13208-A	A	Lens	Right	58	18.50 ea.
B8A-13209-A	B	Lens	Left	58	18.50 ea.
B8A-13211-A	C	Gaskets		58	6.95 pr.
B8A-13238-S	D	Lens Screws	Set of (4)	58	1.95 set

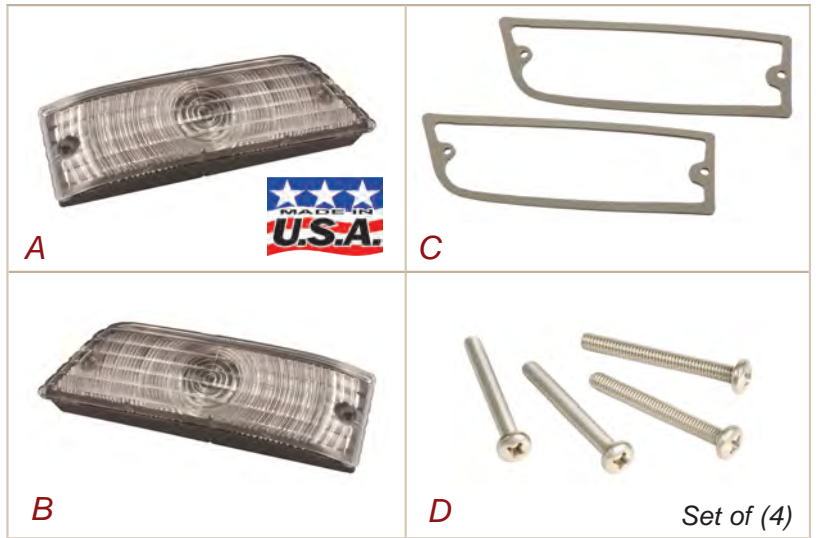
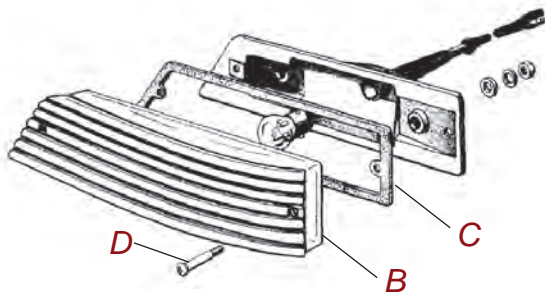

PARK LIGHT PARTS - 1959

PART #	PIC	DESCRIPTION	YEAR	PRICE	
B9AF-13208-A	E	Lens	Right or Left	1959	5.95 ea.
B9A-13238-S	F	Lens Screws	Set of (6)	1959	2.50 set

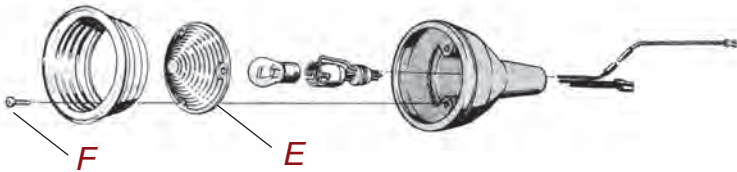

PARK LIGHT - MERCURY

PART #	PIC	TYPE	NOTE	YEAR	PRICE
FAB-13208-A	G	Lens	Plastic - Mercury	52-53	14.95 ea.
FAH-13208-A	H	Lens	Plastic - Mercury	54	89.95 pr.
FDK-13208-A	I	Lens	Plastic - Mercury	55-56	39.95 ea.
FAB-13211	J	Gaskets	Lens - Mercury	52-53	5.95 pr.
FAB-13217	K	Gaskets	Body - Mercury	52-53	5.95 pr.
FAJ-13211-A	L	Gaskets	Lens - Mercury	54	5.95 pr.
FDK-13211-B	M	Gaskets	Lens - Mercury	55-56	5.95 pr.



PARK LIGHT SOCKET & WIRING ASSEMBLY

PART #	PIC	DESCRIPTION	YEAR	PRICE
B6A-13234-A	A	Original Type - (2 terminal)	56	14.95 ea.
BAAA-13410	B	Replacement	52-58	5.95 ea.



PARK LIGHT SOCKET & WIRING ASSEMBLY

With Turn Signal

PART #	PIC	DESCRIPTION	YEAR	PRICE
B7A-13234-A	C	Right Side	57	31.95 ea.
B7A-13235-A	D	Left Side	57	27.95 ea.



PARK LIGHT BULBS

PART #	PIC	TYPE	NOTE	YEAR	PRICE
11A-13465-1154	E	6 volt		42-55	1.50 ea.
B6A-13465-1034	F	12 volt		56-59	1.50 ea.
B7A-13466-1157NA	G	12 volt	Amber Glass	56-59	1.95 ea.



TAILLIGHT BULB

PART #	PIC	DESCRIPTION	YEAR	PRICE
11A-13465-1154	H	6 volt	42-55	1.50 ea.
B6A-13465-1034	I	12 volt	56-59	1.50 ea.



CREE 12V LED BULB
For use with TAILLIGHT / PARKLIGHT

- Direct replacement of original twist in bulb.
- 6 XBD CREE LEDs (4 on sides, 2 on top)
- 320 lumens - 360 degree beam angle
- Replaces 1157 or 1034



LED Bulbs are 100% brighter!!

PART #	COLOR	MODEL	YEAR	PRICE
LED-1157-W1*	WHITE	Must use w/ CLEAR lens	56-87	16.95 ea.
LED-1157-A1*	AMBER	Must use w/ AMBER lens	56-87	16.95 ea.
LED-1157-R1*	RED	Must use w/ RED lens	56-87	16.95 ea.

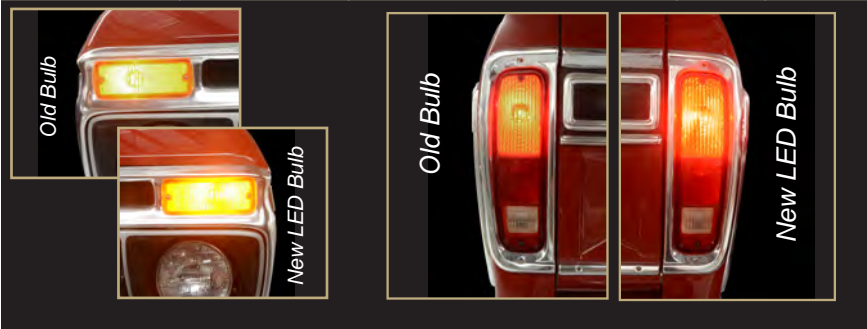

ELECTRONIC 2 PRONG FLASHER w/ Polarity Adapter / Reverser

Use in place of standard 552 flasher if running LED bulbs • Must use with LED bulbs. Includes polarity adapter / reverser which easily reverses + & L terminals without modifying vehicle wiring.

PART #	PIC	TYPE	YEAR	PRICE
LED-552-F	J	Flasher w/ Adapter	56-87	11.95 ea.
LED-552-AR	K	Adapter Only	56-87	4.95 ea.



TAILLIGHT WIRE & SOCKET

PART #	PIC	DESCRIPTION	YEAR	PRICE
8A-13410-A	L	Original	49-52	19.95 ea.
BAAA-13410	M	Replacement	50-58	5.95 ea.
1A-13410-A	N	Mercury	52-53	7.95 ea.



TAILLIGHT WIRING

From Cowl Wiring to Taillights.

PART #	PIC	DESCRIPTION	YEAR	PRICE
Taillight Wiring Harness with Turn Signals				
FAB-14405-S		Convertible	52-53	199.95 ea.
FAB-14405-E		Victoria	52-54	209.95 ea.
FAB-14405-B		Mainline & Customline	52-53	179.95 ea.
FDA-14405-G		Mainline & Customline	54	169.95 ea.
B5A-14405-J		Mainline & Customline	55	139.95 ea.
FAC-14405-B		Mercury	52-53	199.95 ea.
FDC-14405-S		Mercury	54	259.95 ea.

Taillight Wiring Harness without Turn Signals

B6A-14405-D		Taillight Wiring Harness	56-57	179.95 ea.
-------------	--	--------------------------	-------	------------



\$9.99 *or* **\$14.99** **FLAT RATE SHIPPING**
See shipping page for details.

TAILLIGHT - 1952

PART #	PIC	DESCRIPTION	YEAR	PRICE
FAA-13450-C	O	Lens	52	14.95 ea.
FAA-13448-A	P	Rim	52	40.95 ea.
FAA-13420	Q	Body Pads	52-54	9.95 pr.
FAA-13461-C	R	Lens Gasket	52	7.95 pr.

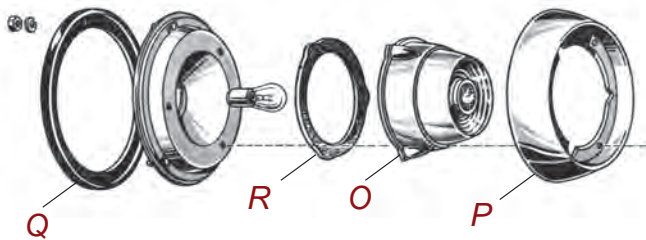

TAILLIGHT - 1953

PART #	PIC	DESCRIPTION		YEAR	PRICE
FAF-13450	A	Lens - Ford Script	w/ Chrome Sleeve	53	19.50 ea.
FDA-13450	B	Lens - Ford Script	w/ Chrome Sleeve	53-54	9.95 ea.
FAA-13489	C	Chrome Sleeve	For Taillight Lens	53	12.50 ea.
B3AZ-13434-A	D	Body	Chrome	53	79.95 ea.
FAA-13420	E	Body Pads		52-54	9.95 pr.
FAE-13461-A	F	Lens Gasket		53-54	5.95 pr.
BF-13449-S	G	Lens Screws	Set of 6	53	5.95 set

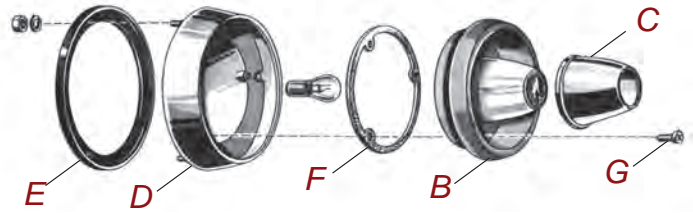

**Premium
PLASTIC
Products**

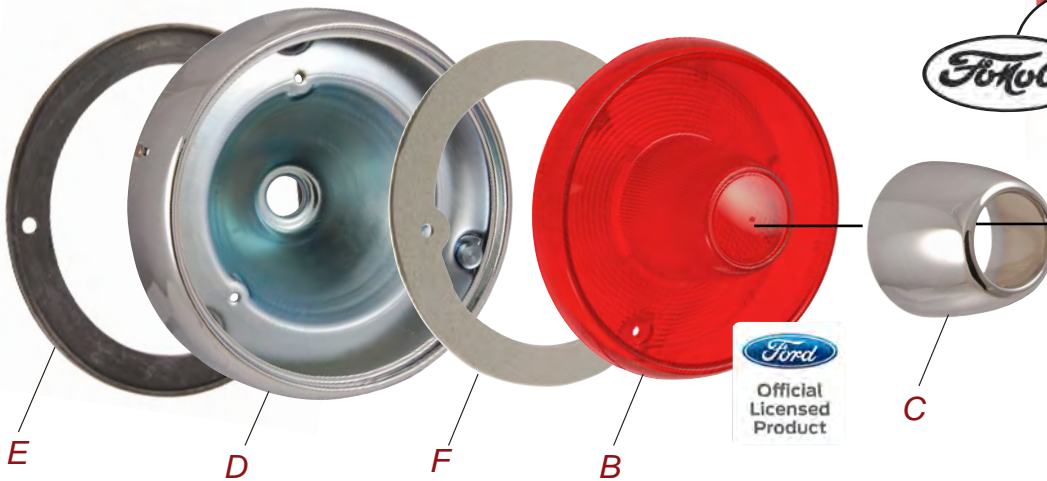

TAILLIGHT - 1954

PART #	PIC	DESCRIPTION	NOTE	YEAR	PRICE
FDA-13450	H	Lens - Ford Script	w/o Chrome Sleeve	53-54	9.95 ea.
B4AZ-13434-A	I	Body	Chrome	54	84.95 ea.
FAA-13420	J	Body Pads		52-54	9.95 pr.
FAE-13461-A	K	Lens Gasket		53-54	5.95 pr.
B4AZ-13489-A	L	Chrome Sleeve	For Taillight Lens	54	24.95 ea.

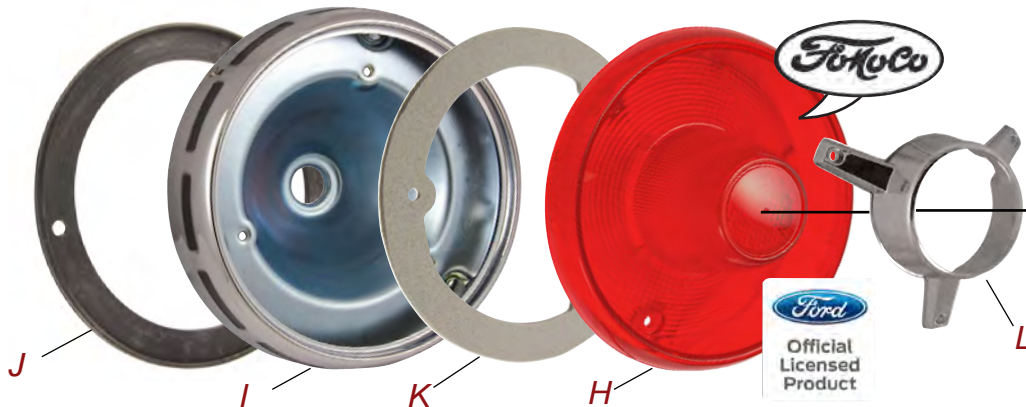
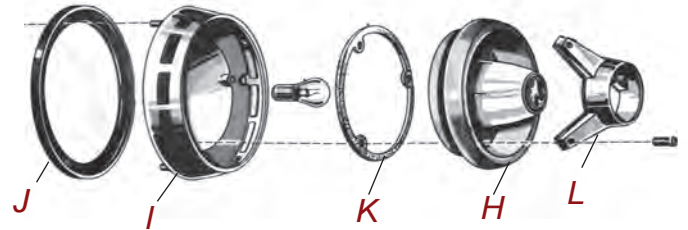

**Premium
PLASTIC
Products**



TAILLIGHT - 1955

PART #	PIC	DESCRIPTION	NOTE	YEAR	PRICE
B5A-13450-A	M	Lens - Ford Script		55	19.95 ea.
B5A-13450-AX		Lens - No Script		55	14.95 ea.
B5A-13489-A	N	Chrome Sleeve	For Taillight Lens	55	13.50 ea.
B5AZ-13434-A	O	Body	Chrome	55	44.95 ea.
B6A-13420-A	P	Body Pads		55-56	14.95 pr.
B5A-13461-A	Q	Lens Gasket		55	5.95 pr.
B5A-13449-S	R	Lens Screws	Set of 6	55	2.50 set

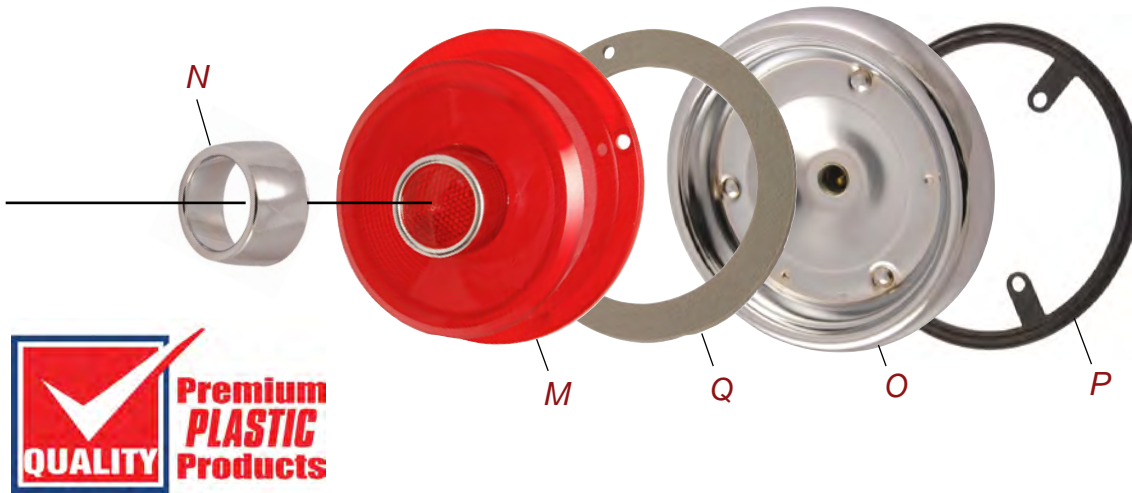
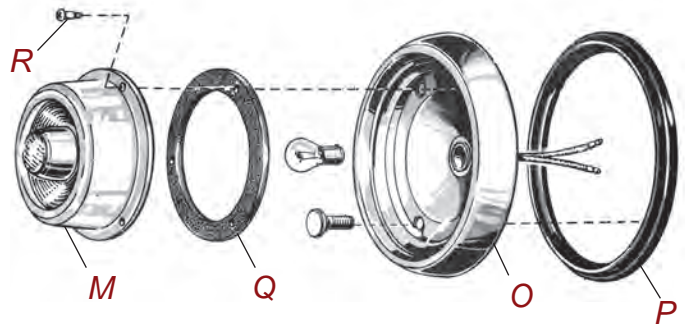

TAILLIGHT PARTS - 1956

PART #	PIC	DESCRIPTION	NOTE	YEAR	PRICE
B6A-13450-A	S	Lens - Ford Script		56	29.95 ea.
B6A-13489-A	T	Chrome Sleeve	For Taillight Lens	56	19.95 ea.
B6AZ-13434-A	U	Body	Chrome	56	44.95 ea.
B6A-13420-A	V	Body Pads		55-56	14.95 pr.
B6A-13461-A	W	Lens Gasket		56	5.95 pr.
B6A-13449-S	X	Lens Screws	Set of 6	56	2.50 set

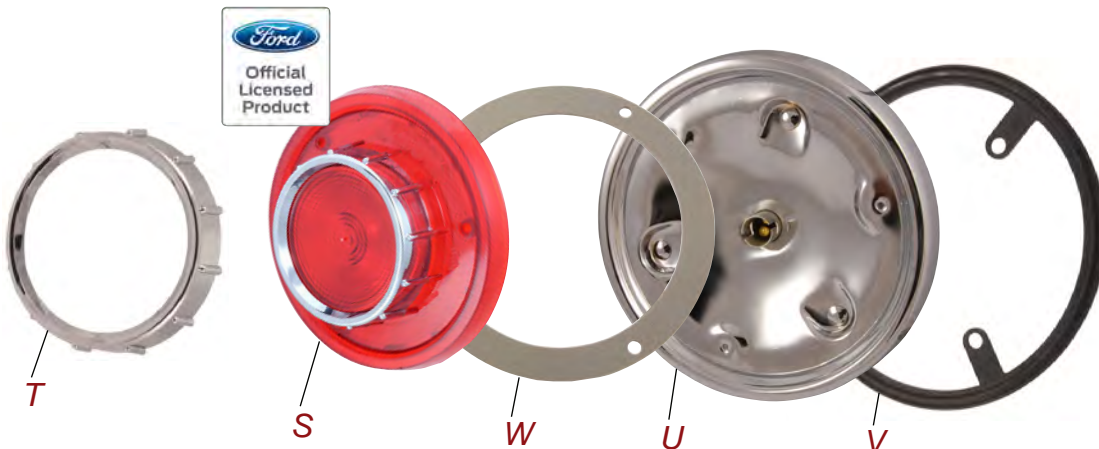
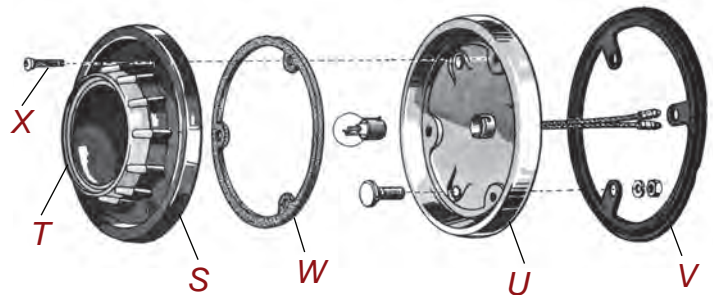

TAILLIGHT - 1957-58

PART #	PIC	DESCRIPTION	FIT	YEAR	PRICE
Taillight Lens - Original Tooling					
B7A-13450-B	A	Lens w/ Back-Up Light	Ranchero & Sedan Delivery	57-58	49.95 ea.
B7A-13450-C	B	Lens w/o Back-Up Light	Ranchero & Sedan Delivery	57-58	14.95 ea.
B8A-13450-A	C	Lens	All ex. Ranchero, S.D. & SW	58	14.95 ea.
B7A-13449-S	D	Lens Screws - Set of (8)	All	57-58	3.95 set

Taillight Sleeve (Plastic)					
B7A-13489-B	E	w/ back-up lights		57	24.95 ea.
B7A-13489-A	F	w/o back-up lights		57	24.95 ea.

Taillight Body Pads					
B7A-13420-PR	G	Contains (2) pads	Fairlane & Fairlane 500	57	9.95 pr.
B8A-13420-D		(6) pcs. - Fin & Oval Type	(#64) 2 & 4 Dr. club sedan	58	24.95 set
B8A-13420-D		(6) pcs. - Fin & Oval Type	(#58) 2 & 4 Dr. town Sedans	58	24.95 set
B8A-13420-D		(6) pcs. - Fin & Oval Type	(#76) Convertible	58	24.95 set
B8A-13420-E	H	(6) pcs. - Fin & Oval Type	(#70) & (#73) 2 & 4 dr. Sedans	58	19.95 set
B8A-13420-F		(6) pcs. - Fin & Oval Type	(#51A) Retractable	58	19.95 set

Taillight Lens Gaskets					
B7A-13461-PR	I	Lens Gasket	All except Wagon	57-58	7.95 pr.
B8A-13461-D	J	Lens Gasket - Set of (4)	All ex. Ranchero & S.D.	58	7.95 set

Taillight Door Trim Pressure Die Cast, Triple Chrome Plated, RH or LH Side					
B7A-13494-PR	K	Trim for Taillight Doors	All Fairlane 500	57	44.95 pr.

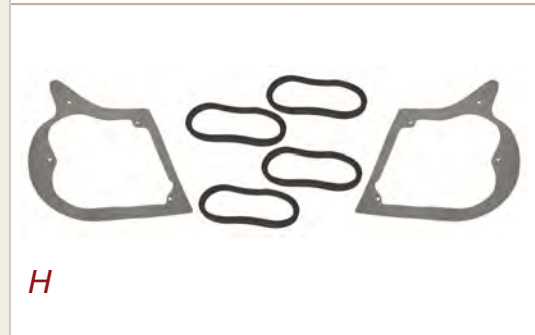
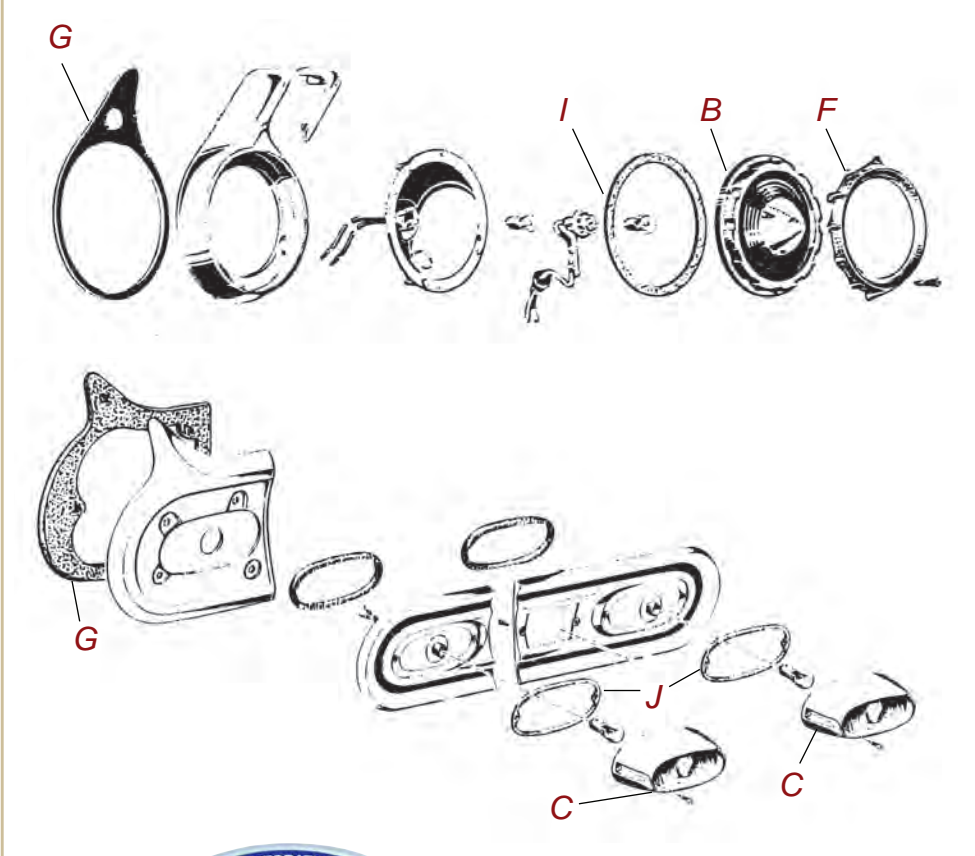
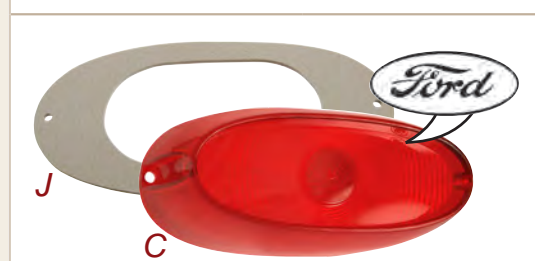

TAILLIGHT - 1959

PART #	PIC	DESCRIPTION	YEAR	PRICE
B9A-13450-A	L	Lens	59	14.95 ea.
B9A-13420-A	M	Body Pads	59	9.95 pr.
B9A-13461-A	N	Lens Gasket	59	7.95 pr.
B9A-13449-S	O	Lens Screws - set of (6)	59	2.50 set

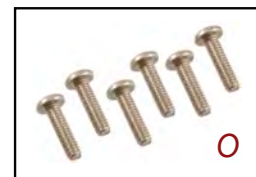
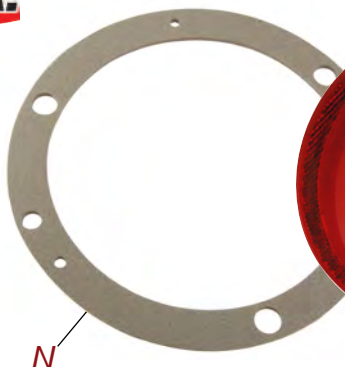
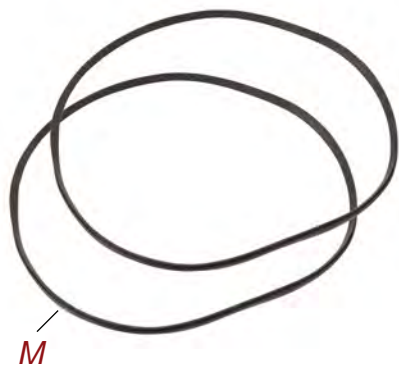
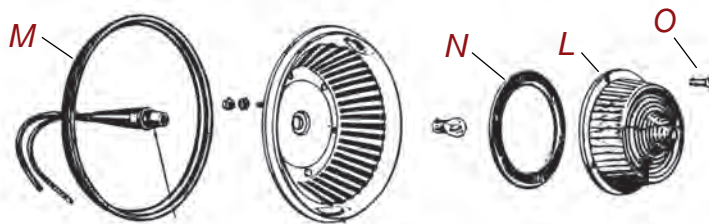

TAILLIGHT LENS - MERCURY

Plastic - Sold in pairs

PART #	PIC	DESCRIPTION	YEAR	PRICE
FAB-13450-A	A	Taillight Lens - Upper	52-53	59.95 pr.
FAH-13450-PR		Taillight Lens	54	79.95 ea.
FDK-13450-B	B	Taillight Lens	55	99.95 pr.
FDT-13450-B	C	Taillight Lens - Ford Script	56	99.95 pr.



A

B

C

Does not fit Wagon

TAILLIGHT REFLECTOR - MERCURY

Part #	1M-13437
Type	Plastic
Note	Round Red
Year	1951-53 & 57
Price	14.95 ea.

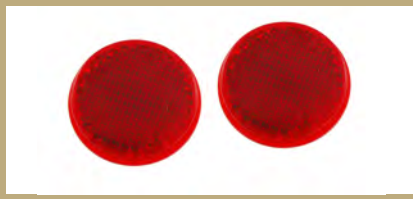

TAILLIGHT GASKETS - MERCURY

PART #	PIC	DESCRIPTION	YEAR	PRICE
FAB-13461-A	D	Taillight Lens to Housing Gasket	52-53	7.95 pr.
FAF-13461-A	E	Taillight Lens to Housing Gasket	54	7.95 pr.
FDK-13461-A	F	Taillight Lens to Housing Gasket	55	7.95 pr.
FDT-13461-A	G	Taillight Lens to Housing Gasket	56	7.95 pr.
FAA-13453-A	H	Taillight Housing Seal	54	9.95 pr.

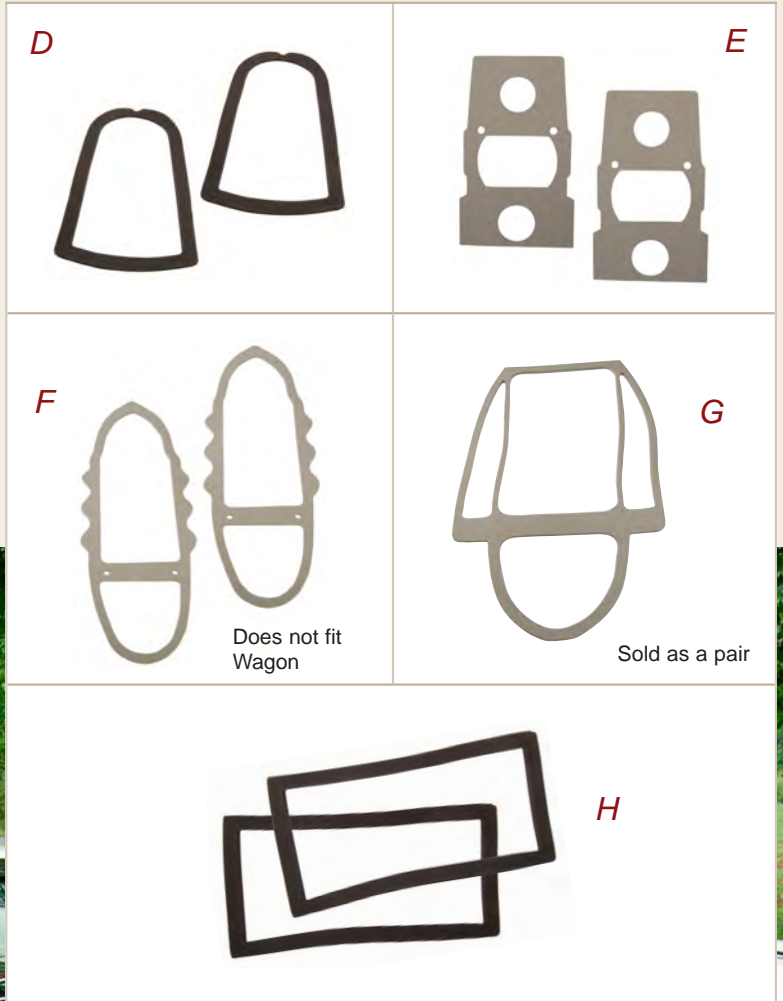

D

E

F

G

Does not fit Wagon

Sold as a pair

H

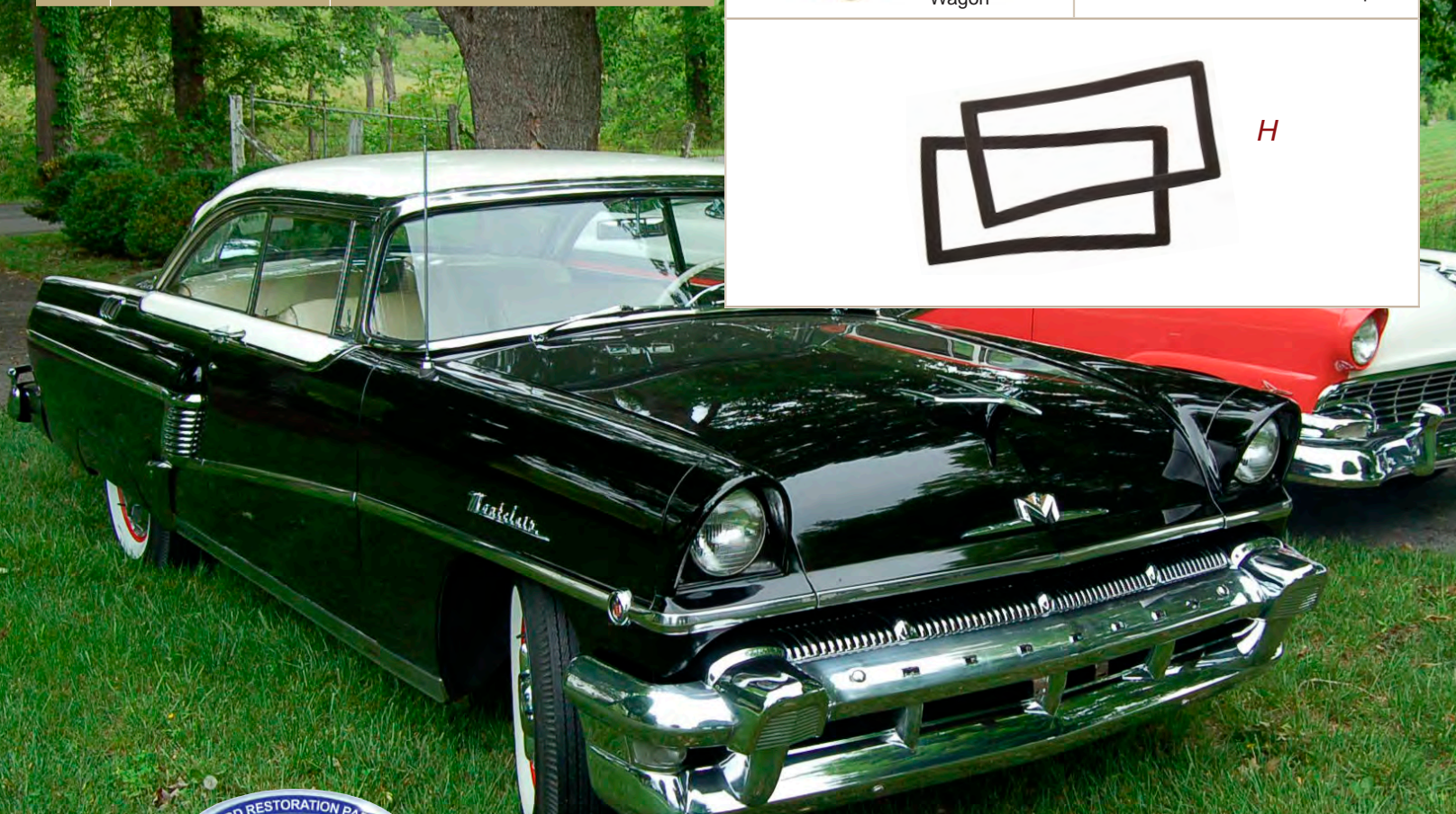

TURN SIGNAL KNOB

PART #	PIC	DESCRIPTION	YEAR	PRICE
1M-13305-A	I	Black - Mercury	50-53	24.95 ea.
1A-13305	J	Black	52-53	5.95 ea.
B4A-13305	K	Black	54-56	5.95 ea.
B7A-13305-B	L	Black	57	5.95 ea.
B8A-13305-W	M	White	58-59	5.95 ea.



BLUE DOT

Part #	BD-13450-S
Type	Glass with Chrome Retainer
Note	To install in old lens.
Year	ALL
Price	6.95 ea.



TURN SIGNAL WIRING

PART #	PIC	DESCRIPTION	YEAR	PRICE
FAB-14404-A	S	Turn Signal Flasher Wires	53-54	69.95 ea.
FAC-14486-B	T	Turn Signal Switch to Wires	52-54	34.45 ea.
0A-14499	U	Front Turn Signal Wires	42-54	34.95 ea.
B9A-13341-A	V	Turn Signal Switch Wire	59-62	24.95 ea.



TURN SIGNAL SWITCH

PART #	PIC	DESCRIPTION	YEAR	PRICE
B5A-13341-A	N	Turn Signal Switch	51-55	59.95 ea.
B8A-13341-A	O	Turn Signal Switch	56-58	59.95 ea.



TURN SIGNAL FLASHER

PART #	PIC	DESCRIPTION	YEAR	PRICE
A9AZ-13350	P	3 prong - 6 volt	49-55	9.95 ea.
B3A-13350-A	Q	2 prong - 6 volt	53-55	4.95 ea.
B6A-13350-A	R	2 prong - 12 volt	56-59	4.95 ea.



\$9.99 *or* **\$14.99** **FLAT RATE SHIPPING**
See shipping page for details.



BACK-UP LIGHT - MERCURY

PART #	PIC	DESCRIPTION	YEAR	PRICE
FAC-15514-A	A	Back-Up Light Lens - Plastic	54	79.95 pr.
FAF-13461-A	B	Taillight Lens to Housing Gasket	54	7.95 pr.
FAA-13453-A	C	Taillight Housing Seal	54	9.95 pr.
FDT-15514-A		Backup Lamp Lens	56	59.95 pr.
FAA-13542-A		Backup Lamp Lens	52-53	69.95 pr.
FAA-13460-A		Backup Lamp Lens Seals	52-53	9.95 pr.

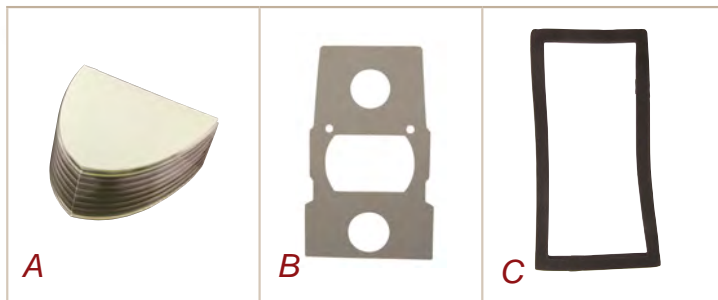
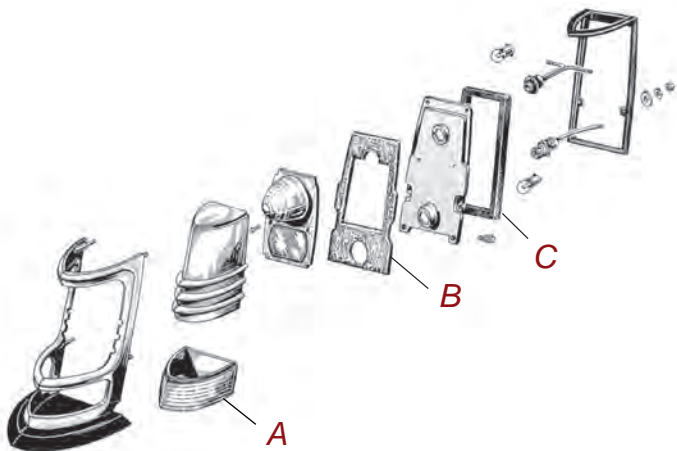

\$9.99 *or* **\$14.99**

FLAT RATE SHIPPING

See shipping page for details.

BACK-UP LIGHT - 1952-54

PART #	PIC	DESCRIPTION	YEAR	PRICE
FAB-15533-A	D	Housing to Body Gasket	52-54	11.95 pr.
FAA-15510	E	Lens Gasket	52-54	4.95 pr.
51A-15517	F	Switch Bracket	49-54	9.95 ea.
51A-15520-A	G	Light Switch	49-54	9.95 ea.

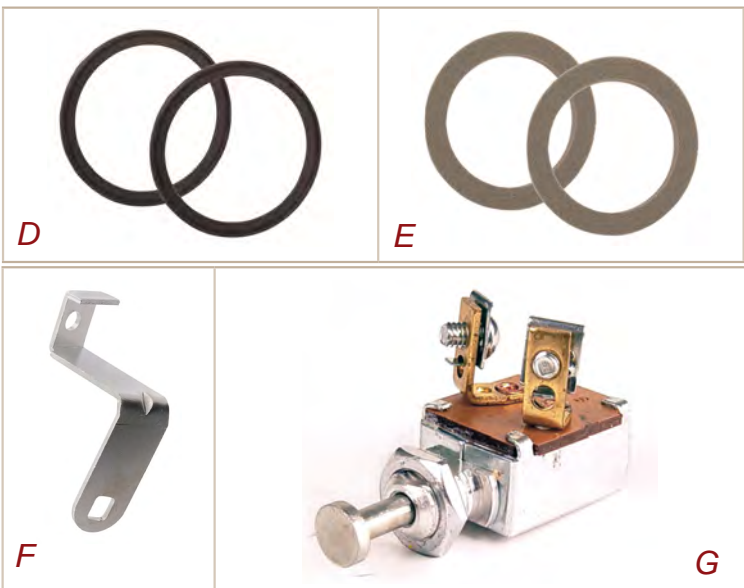
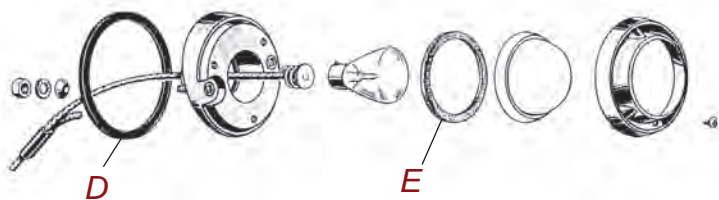

BACK-UP LIGHT - 1955-56

PART #	PIC	DESCRIPTION	YEAR	PRICE
B5A-15514-A	H	Lens w/ Script	Mainline & Customline	55-56 11.95 ea.
B6A-15514-B	I	Lens w/ Script - Genuine Ford	Fairlane	56 11.95 ea.
B5A-15510	J	Lens Gasket	All	55 5.95 pr.
B5A-15510	J	Lens Gasket	Mainline & Customline	56 5.95 pr.
B6A-15510	K	Lens Gasket	Fairlane	56 5.95 pr.
B5A-15510-B	L	Cover Gasket - Rubber (Not Used with Back-Up Light)		55-56 9.95 pr.
B5A-15515-PR	M	Light Housing	All	55 99.95 pr.
B5A-15515-PR	M	Light Housing	Mainline & Customline	56 99.95 pr.
B6A-15515-PR	N	Light Housing		56 114.95 pr.
B5A-15517-A	O	Switch Bracket		55-56 17.50 ea.
B5A-15533-A	P	Housing to Body Gasket	All	55 7.95 pr.
B5A-15533-A	P	Housing to Body Gasket	Mainline & Customline	56 7.95 pr.
B6A-15533-A	Q	Housing to Body Gasket	Fairlane	56 5.95 pr.
B6A-13437-A	R	Light Housing Reflector - Red		56 4.95 ea.

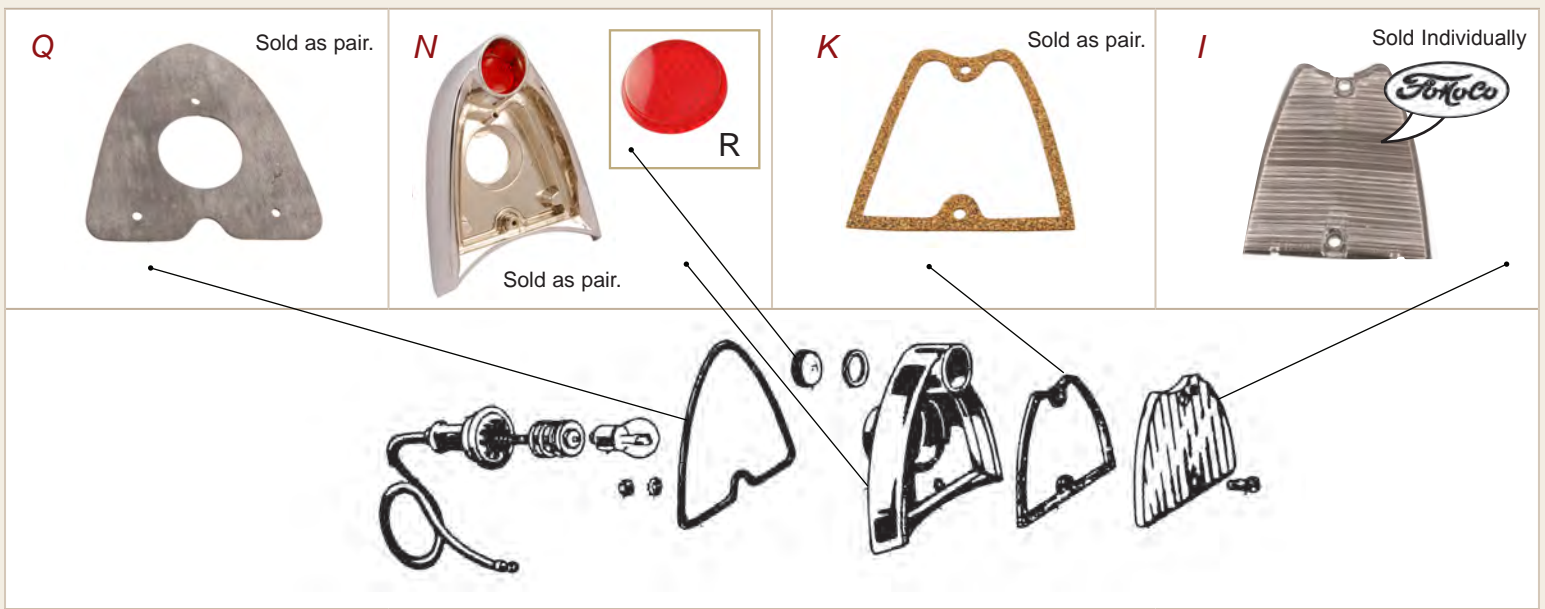
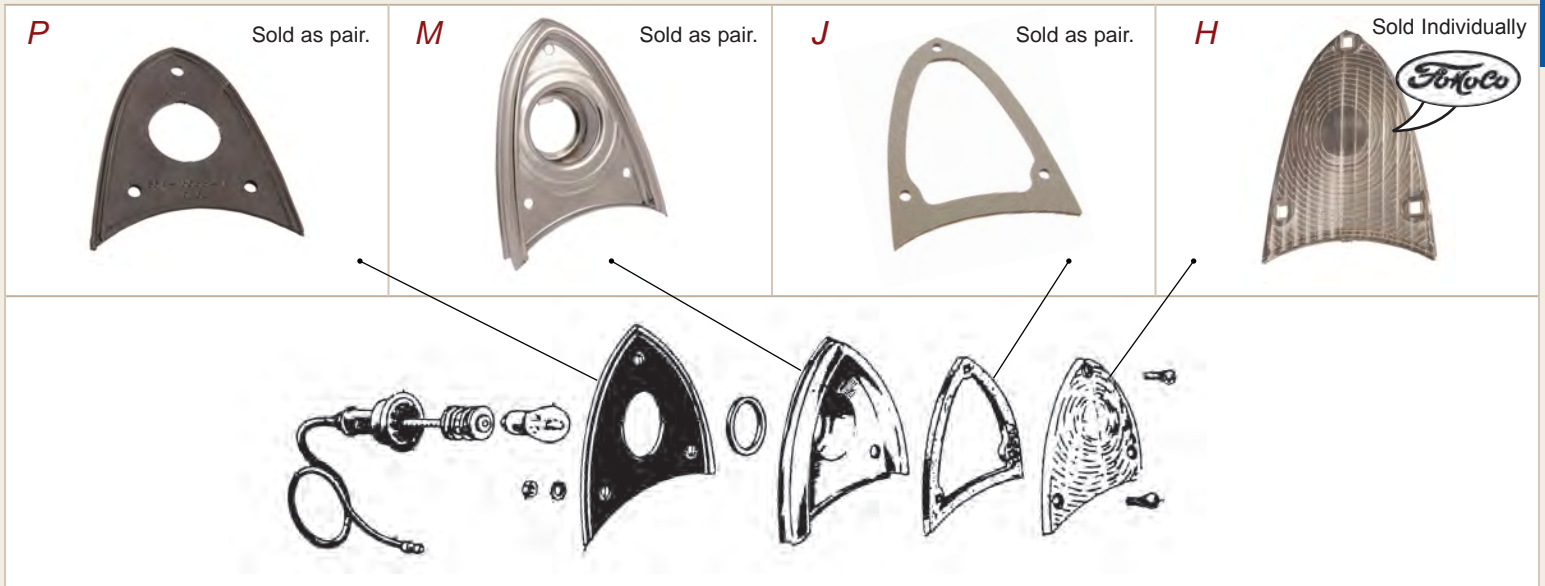

BACK-UP LIGHT - 58-59

PART #	PIC	DESCRIPTION	YEAR	PRICE
B9A-15514-A	A	Lens	59	24.95 ea.
B8A-15510-B	B	Lens Gasket	All ex. Ranchero, S.D. & SW	58 5.95 pr.
B9A-15510-A	C	Lens Gasket	59	5.95 pr.
B7A-15517-A		Switch Bracket	57-58	17.50 ea.
B8A-15533-B	D	Light Housing to Body Gasket	All ex. Ranchero, S.D. & SW	58 5.95 pr.
B9A-15533	E	Light Housing to Body Gasket	59	5.95 pr.
B9A-13420-B	F	Light Housing to Body Gasket	59	9.95 pr.
359846-RD	G	Back-up Light Lens Screw	Round Lens - Set of (4)	58 3.95 set
359846-SQ		Back-up Light Lens Screw	Square Lens - Set of (4)	58 3.95 set
371211-S		Back-up Light Lens Screw	Set of (6)	59 3.95 set
FEG-13410-A	H	Back-up Lamp Socket & Wire	All	58 23.95 ea.
FEG-13410-A	H	Back-up Lamp Socket & Wire	Ranchero & Sedan Delivery	58 23.95 ea.

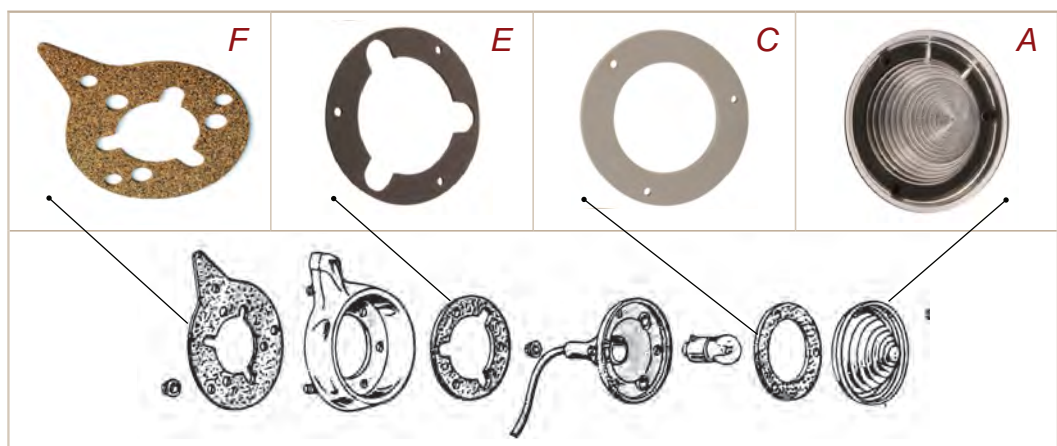

CIGAR LIGHTER ELEMENT & WELL

PART #	PIC	DESCRIPTION	YEAR	PRICE
11A-15055	I	6 volt	49-55	19.95 ea.
B6C-15055	J	12 volt	56	14.95 ea.



Cigar Lighter To Circuit Breaker Wire

Part #	FEG-14347-A
Type	6 cylinder
Year	1957-58
Price	9.95 ea.



DOME LIGHT LENSES & BEZELS

PART #	PIC	NOTE	FIT	YEAR	PRICE
Dome Light LENSES					
FAA-13783-A	A	FORD	All ex. Conv. & Hardtop	52-53	6.95 ea.
FAA-13783-B	B	FORD	Victoria at rear pillar	52-54	24.95 ea.
FDA-13783-A	C	FORD	All ex. Conv. & Hardtop	54	7.95 ea.
FDA-13783-A	C	FORD	All Except Convertible	55-56	7.95 ea.
FAB-13783-A	D	MERCURY	2 Dr, 4 Dr, & Wagon	52-55	14.95 ea.
FAC-13783-A	E	MERCURY	Hardtop Body #MA 60B, 60F	52-54	14.95 ea.
B8A-13783-A	F			57-58	6.95 ea.
B8S-13783-B	G			59	6.95 ea.

Dome Light BEZELS					
B7A-13787-B	H	Chrome Plastic		57-58	19.95 ea.
C0TF-13787-A	I	Chrome Plastic		59	19.95 ea.

DOME LIGHT SWITCH FOR DOOR POST

Part #	8M-13713
Year	1949-60
Price	5.95 ea.



DOME Light Bulbs

Part #	B-13466-63
Type	Dome Light
Note	6 volt
Year	1949-53
Price	0.95 ea.



COURTESY Light Bulbs

Part #	B-13466-63
Type	Courtesy Light
Note	6 volt
Year	1949-55
Price	0.95 ea.



Part #	09B-13466-67
Type	Dome Light
Note	12 volt
Year	1956-59
Price	0.95 ea.



Part #	09B-13466-67
Note	Courtesy Light
Fits	12 volt
Year	1956-59
Price	0.95 ea.



B



A

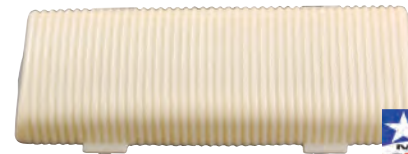

C



D



E



F



G



REAR LICENSE PLATE LIGHT ASSEMBLIES

All assemblies include wiring & socket, housing, lens, lens gasket, mounting bracket.

PART #	PIC	DESCRIPTION	YEAR	PRICE
*FAA-13550-A	A	All except Wagon	52-54	34.95 ea.
*B5A-13550-A	B	All except Wagon	55-56	34.95 ea.
B8A-13550-A	C	All ex. Retractable, Wagon, Sedan Delivery & Ranchero	57-58	34.95 ea.
D0TZ-13550-R		Replacement Style	57-58	12.50 ea.
B9A-13550-A	D	All except Wagon & Ranchero	59-60	34.95 ea.



A

Made Exactly Like **Original**
NOT A GENERIC REPLACEMENT



B



C



D



Made **EXACTLY**
Like The Originals!

LICENSE PLATE LIGHT SOCKET & WIRE ASSEMBLY

PART #	PIC	DESCRIPTION	YEAR	PRICE
BA-13560	E	Replacement - All except Wagon	52-59	9.95 ea.
*FAA-13560-A	F	All except Wagon	52-58	14.95 ea.
C3AZ-13560-A	G		59-63	19.95 ea.

E



F



G



LICENSE PLATE LAMP BULB

Part #	B-13466-63
Type	6 volt
Year	1949-55
Price	0.95 ea.



Part #	09B-13466-67
Type	12 volt
Year	1956-59
Price	0.95 ea.

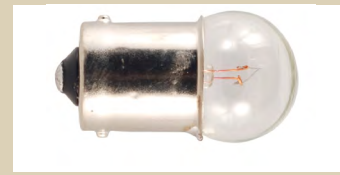

LICENSE PLATE LIGHT SCREWS

PART #	DESCRIPTION	YEAR	PRICE
31061-S	Fits all except Wagon	52-56	3.95 set



\$9.99 *or* **\$14.99** **FLAT RATE SHIPPING**
See shipping page for details.



REAR LICENSE PLATE LIGHT LENS, GASKETS, BRACKETS, & BRACKET PAD

PART #	PIC	DESCRIPTION	YEAR	PRICE
--------	-----	-------------	------	-------

REAR LICENSE PLATE LIGHT LENS

7RA-13564	H	Wagon, Sedan Delivery	52	9.95 ea.
C1TB-13564-A	I	All ex. Wagon, Sedan Delivery	52-58	9.95 ea.

REAR LICENSE PLATE LIGHT LENS GASKET

7RA-13568		Wagon, Sedan Delivery	52	1.95 ea.
FAA-13568-A	J		52-58	1.95 set
B9A-13568-A	K		59-63	0.95 ea.

Rear License Plate Light BRACKETS

FAA-13423-A	L	All ex. Wagon	52-54	7.95 ea.
B5A-13423-A	M	All ex. Sedan Delivery & Wagon	55-56	7.95 ea.
B8A-13423-A	N	All ex. Retractable, Wagon, Sedan Delivery, & Ranchero	57-58	7.95 ea.

Rear License Plate Light BRACKET PAD

*B5A-13572-B	O	Wagon Only	55-56	14.95 ea.
--------------	---	------------	-------	-----------



LICENSE PLATE BOLT with GLASS REFLECTORS\$9.95 ea.

PART #	PART #	PART #	PART #
LP-2R	LP-2A	LP-2B	LP-2G

**Real Glass, not plastic.
Made in the USA.**

LICENSE PLATE LIGHT COVER

PART #	PIC	DESCRIPTION	YEAR	PRICE
7RA-13566	P	Wagon, Sedan Delivery	52	14.95 ea.
B9A-13566-A	Q		59-60	4.95 ea.



LICENSE PLATE LIGHT & FUEL SENDERS WIRE

Part #	FAB-14415-A
Fit	Mercury
Year	1952-53
Price	13.95 ea.



LICENSE PLATE LIGHT WIRE GROMMET

Part #	1A-14567
Note	Goes where Wire comes in bottom back of trunk
Year	1957-59
Price	2.95 ea.



WIRING CLIPS

Part #	51C-14197
Type	Brake/Fuel Line Metal Clips
Note	7/16"
Year	1952-59
Price	2.95 ea.



Part #	8M-14197
Type	Wiring Harness to Body Metal Clips
Note	17/32"
Year	1952-59
Price	2.95 ea.



Part #	354362-S
Type	Firewall Metal Clip
Note	
Year	1955-58
Price	1.95 ea.



COWL WIRING GROMMET

Part #	1A-14603-B
Type	Cowl Wiring Firewall Grommet
Year	1951-59
Price	3.95 ea.



Part #	8A-14608
Type	Cowl Wiring Grommet Retainer
Year	1949-59
Price	9.95 ea.



METAL WIRE GROMMETS

Part #	352873-S
Type	Small
Size	11/16" OD - 1/2" ID
Year	All
Price	3.95 ea.



Part #	352873-L
Type	Large
Size	25/32" OD - 5/8" ID
Year	All
Price	3.95 ea.



MALE WIRE ENDS

Part #	B-14637-B
Price	0.50 ea.



JUNCTION BLOCKS FOR WIRING

PART #	PIC	DESCRIPTION	YEAR	PRICE
FDT-14448-A	A	Doublestack for under hood	49-59	24.95 ea.
FDT-14448-B	B	Single Stack	49-59	19.95 ea.
FDT-14448-C	C	Double stack for under dash	49-59	24.95 ea.



COWL OR DASH WIRING

PART #	PIC	DESCRIPTION	YEAR	PRICE
FAB-14401-D	D	6 cylinder	52	354.95 ea.
FAH-14401-H		6 cylinder	53	344.95 ea.
B5A-14401-D	E	6 cylinder	55	494.95 ea.
B6A-14401-E		6 cylinder	56	654.95 ea.
FAA-14401-D		8 cylinder	52	399.95 ea.
FAG-14401-H		8 cylinder	53	344.95 ea.
FDB-14401		8 cylinder	54	359.95 ea.
B5A-14401-H		8 cylinder	55	494.95 ea.
B6A-14401-F		8 cylinder	56	654.95 ea.
B7A-14401-H		8 cylinder except Retractable	57	609.95 ea.
B8A-14401-A		6 & 8 cylinder	58	517.95 ea.
B9A-14401-A		6 & 8 cylinder	59	326.95 ea.
FAW-14401-A		Mercury	52-53	601.95 ea.
FDK-14401-C		Mercury	55	569.95 ea.
FDT-14401-C		Mercury	56	581.95 ea.



**INSTRUMENT CLUSTER
VOLTAGE REGULATOR**

Part #	B9MZ-10804-C
Note	Located on back of instrument cluster
Year	1957-59
Price	21.95 ea.



**GENERATOR TO VOLTAGE
REGULATOR WIRING**

8 cylinder

PART #	PIC	DESCRIPTION	YEAR	PRICE
FDB-14305-A	F	Ford	54	29.95 ea.
FDC-14305-A	G	Mercury	54	56.95 ea.
B5A-14305-B	H		55	29.95 ea.
B6A-14305-D	I	for 40,50, or 60 amp generator	56	34.95 ea.
B7A-14305-B	J	for 100 amp alternator system	57	39.95 ea.
B8A-14305-D	K	for 30,50, or 100 amp alternator system	56-58	69.95 ea.



**Carpenter
NEWSLETTER**

Sign up at Dennis-Carpenter.com.

Latest Car Show Information • New Products
Customer Testimonials • Online Catalogs • Sales
Discounts • Promotions • News & Updates

*Get on the mailing list...
Today!*



For Orders Only: 1-800-476-9653
Shop Online at DENNIS-CARPENTER.COM



FENDER, HOOD, & EXTERIOR → FRONT FENDER

FRONT FENDER / SPLASH APRON SEALS

PART #	PIC	DESCRIPTION	NOTE	YEAR	PRICE
BA-16126-A	A	Front Fender To Cowl Pad	Top back of fender	52-56	4.95 pr.
B7A-16126	A	Front Fender To Cowl Pad	Top back of fender	57	3.95 pr.
BA-16170-A	B	Front Fender to Splash Apron Anti-Squeak	140"	52-54	14.95 ea.
B5A-16170-A		Front Fender to Splash Apron Anti-Squeak	72"	55-60	7.95 ea.
B5A-16172	C	Front Fender Center To Cowl Pad	Center of fender	55-58	2.95 ea.
BM-16240		Front Fender Inner Splash Apron to Suspension Arm Seal		54	24.95 pr.
B5A-16240	D	Front Fender Inner Splash Apron to Suspension Arm Seal		55-56	24.95 pr.

Front Fender Inner Splash Apron to Frame Weatherstrip

Installed on fender splash apron
& bottom of radiator side deflectors

PART #	PIC	DESCRIPTION	YEAR	PRICE
BA-16254		(6) pieces per kit	52-53	19.95 kit
BM-16254		(6) pieces per kit	54	19.95 kit
B5A-16254		(6) pieces per kit	55-56	19.95 kit
B7A-16254-S	E	(4) pieces per kit	57-58	19.95 kit

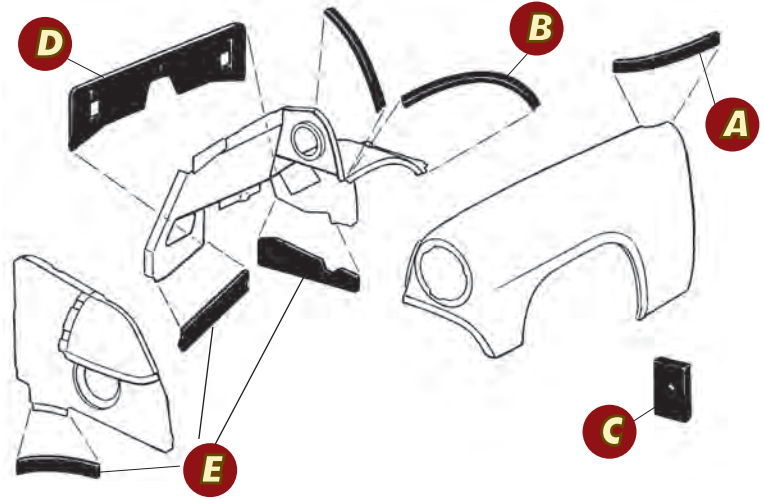

FENDER SCRIPTS

Fasteners Included

PART #	PIC	DESCRIPTION	YEAR	PRICE
B5A-16098-B	F	"CustomLine" Script	55	69.95 pr.
B7A-16098-PR	G	"Fairlane" Script	57	99.95 pr.



LOWER FRONT FENDER ORNAMENTS

Chrome Plated

PART #	PIC	DESCRIPTION	YEAR	PRICE
B9A-16174-PR			59	249.95 pr.

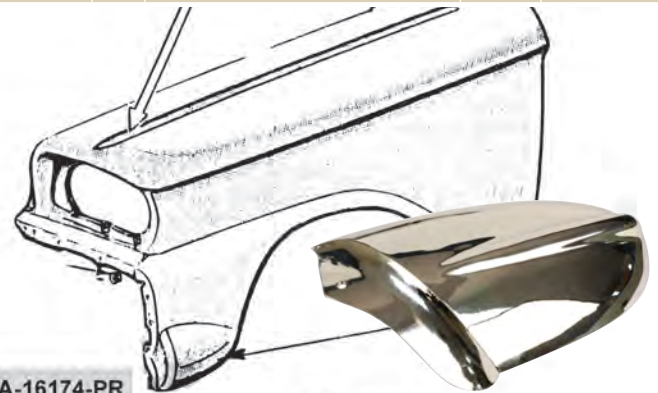

B9A-16174-PR
Lower Front Fender Ornaments - Chrome Plated

FRONT FENDER APRON TO RADIATOR SUPPORT REINFORCEMENT

PART #	PIC	DESCRIPTION	YEAR	PRICE
BA-16142-A		RH - NOS - Limited Supply	52-53	39.95 ea.
BA-16143-A		LH - NOS - Limited Supply	52-53	39.95 ea.

FRONT FENDER SPLASH SHIELD

PART #	DESCRIPTION	YEAR	PRICE
AB-16550	NOS - Limited Supply	52-53	74.95 ea.

FRONT FENDER APRON

PART #	DESCRIPTION	YEAR	PRICE
BF-16054-A	RH - NOS - Limited Supply	1953	149.95 ea.

FRONT FENDER TOP ORNAMENT

PART #	PIC	DESCRIPTION	YEAR	PRICE
B8AZ-16178-A	H	(2) per car	58	74.95 ea.
B9AB-16178-B	I	(2) per car	59	74.95 ea.



"MONTCLAIR" Front Fender Script
Mercury

PART #	DESCRIPTION	YEAR	PRICE
BV-16098-A	• Includes fasteners • Goes on Front Fender	55-56	74.95 ea.



FRONT FENDER EMBLEMS
Mercury

Part #	BU-16228-A
Type	
Fits	Body Type 57,58,64,73,76,79
Year	1956
Price	99.95 ea.



Part #	1M-7221020
Type	Colored Plastic w/ Polished Metal Bezel
Fits	RH or LH Fender
Year	1952-53
Price	99.95 ea.



Part #	BR-16228-A
Type	
Fits	
Year	1954-55
Price	74.95 ea.



"V-8" FRONT FENDER EMBLEM

Part #	1BA-16237-PR
Type	Die Cast Chrome
Note	Includes Fastners
Year	1951-53
Price	39.95 pr.



Part #	BM-16237-PR
Type	Die Cast Chrome
Note	Includes Fastners
Fits	- ex. 56 Fairlane
Year	1956
Price	39.95 pr.



"Fairlane T-Bird V8"
FRONT FENDER EMBLEM

Part #	B6A-16228-PR
Type	Die Cast Chrome w/ Red Background
Note	Includes Fastners
Year	1956
Price	39.95 pr.



50,000
PART NUMBERS
IN STOCK!
SHOP ONLINE
www.dennis-carpenter.com

HOOD ORNAMENTS

Includes Fasteners

PART #	PIC	DESCRIPTION	YEAR	PRICE
B6A-16850-B	A	Die Cast Chrome	56	129.95 ea.
B7A-16850-A	B	Custom Model	57	99.95 ea.
B7A-16850-B	C	Fairlane Model	57	99.95 ea.



A

New Lower PRICE!



C

B



"FORD" HOOD LETTERS

PART #	PIC	DESCRIPTION	YEAR	PRICE
B7A-16606-S	F	Custom, Ranchero	57	74.95 set



F



"FAIRLANE" HOOD SCRIPT

Includes Fastners

PART #	PIC	DESCRIPTION	YEAR	PRICE
B5A-16604-B	G		55-56	17.95 ea.
B7A-16604-A			57	29.95 ea.
B8A-16604-A			58	79.95 ea.

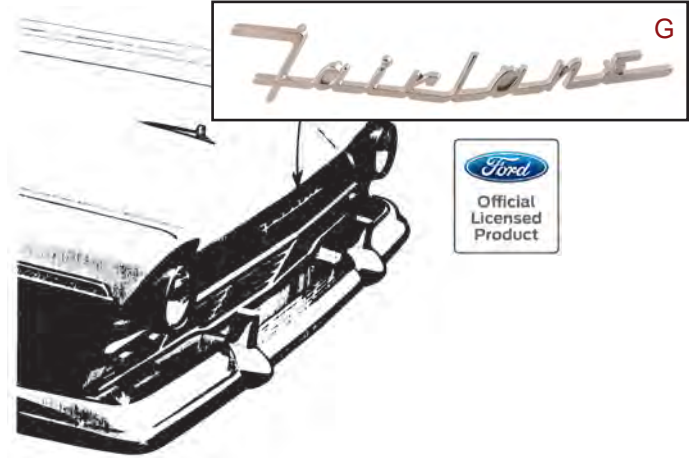

G



HOOD SCOOP - 1958

PART #	PIC	DESCRIPTION	YEAR	PRICE
B8A-16675-A	E	Hood Scoop to Hood Pad	58	4.95 ea.



E

#63A...#76 HUH??

What do these numbers mean in our catalog?



Various parts in this catalog are identified with Body Type Codes. A complete listing of these codes and the body types which they represent are shown on page 149.

For instance, a 54A would equal a Galaxie Town Sedan.

This code can be found on the Body Plate located on the door pillar of your car.

This way you can be sure the parts you're ordering fits your car!

**FRONT OF HOOD
EMBLEMS, BEZEL, & PAD**

PART #	PIC	DESCRIPTION	YEAR	PRICE
Hood Emblems Plastic - Made in U.S.A.				
BA-16637-A	I	All	52-54	44.95 ea.
BA-16637-A	I	All ex. Fairlane Series	55-56	44.95 ea.
B5A-16637-B	J	Fairlane Series	55-56	44.95 ea.
B9A-16607	K	Fairlane & Fairlane 500	59	49.95 ea.
Hood Emblem BEZELS Includes Fasteners				
BA-16644-A	L	All except Fairlane	52-54	44.95 ea.
B5A-16644-C	N	Fairlane Only	55-56	44.95 ea.
B5A-16644-D		All except Fairlane	55-56	44.95 ea.
B9A-16644-A	M	Die Cast Chrome	59	49.95 ea.
Hood Emblem PADS Sponge Type				
0A-16675			50-54	0.95 ea.
B5A-16675-S		Also fits Trunk Lid emblem	55-56	0.95 ea.

FRONT OF HOOD EMBLEMS - MERCURY

PART #	PIC	DESCRIPTION	YEAR	PRICE
BC-16637-A		Plastic - Mercury	52-53	74.95 ea.
BR-16637-A	O	Plastic - Mercury	54-55	74.95 ea.



O



I



J



K



L



N



M

HOOD PULL CABLE

PART #	PIC	DESCRIPTION	YEAR	PRICE
B7A-16993-A	A	Hood Pull Rubber Bumper	57-58	1.95 ea.
352961-S	B	Hood Pull Cable Firewall Grommet	57-59	0.95 ea.
B7A-16916-B	C	Hood Pull Cable & Housing	57-59	24.95 ea.



COWL LACING

Complete with tacks to install

PART #	PIC	DESCRIPTION	YEAR	PRICE
*BA-16740-B		Ford & Mercury	52-54	8.95 ea.
B5A-16740	F	Ford	55-56	7.95 ea.
B7A-16740	F	Rubber Strip	57-58	7.95 ea.
B9A-16740		Rubber Strip	59	7.95 ea.
BN-16740		Rubber - Mercury	55-56	14.95 ea.

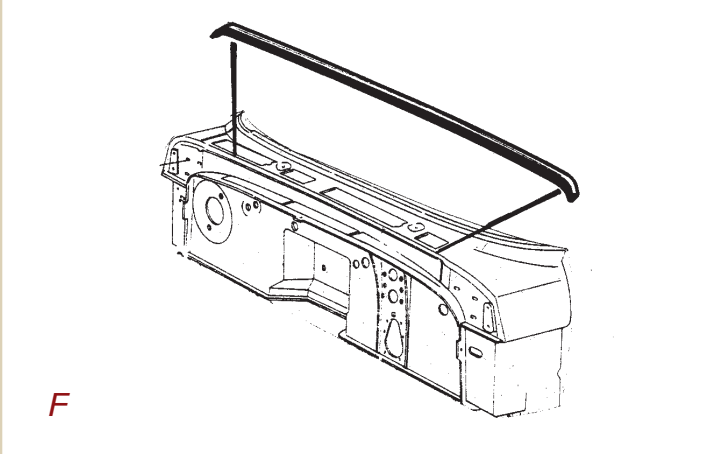

HOOD TORSION BAR ANTI-RATTLER

Part #	B9A-16792-S
Year	1959
Price	2.95 ea.



\$9.99 *OR* **\$14.99** **FLAT RATE SHIPPING**
See shipping page for details.

HOOD BUMPER KITS

PART #	PIC	DESCRIPTION	YEAR	PRICE
B5A-16761	D	Hood Bumper Kit - 10 pieces	55-56	19.95 kit
BA-16761	E	Hood Bumper Kit - 10 pieces	52-54	14.95 kit



COWL ACCESS HOLE PLUG

Part #	352811-S
Year	1957-58
Price	1.95 ea.



HOOD BUMPERS

PART #	PIC	LOCATION	YEAR	PRICE
B5A-16769	G	Front of Hood	55-56	7.95 pr.
B7A-16758-A	H	Side of Hood to Fender	57-59	6.95 set
B5A-16769		Top of Cowl to Hood	57-58	7.95 pr.
B9A-16769-A	I	Top of Cowl to Hood	59	8.50 pr.



HOOD HINGE ASSEMBLY TO BODY SEAL

Part #	8M-16897-B
Note	Includes Pin
Year	1951-52
Price	7.50 kit



HOOD LOCK TRIGGER SPRING

Part #	B6A-16921-A
Note	Replacement Type
Year	1956-59
Price	4.95 kit



HOOD SAFETY CATCH SPRING

Part #	*BF-16812-A
Year	1952-54
Price	14.95 ea.



HOOD HINGE SPRING

Part #	BA-16878-A
Year	1952-54
Price	14.95 pr.



HOOD HINGE BOLTS

Part #	8A-16798-S
Type	Hood Hinge Bolt with Shoulder
Note	Need (2) per hinge
Year	1949-53
Price	2.95 ea.



Part #	20327-S
Type	Hood Hinge Bolt Set
Note	5/16"x24x9/16" Set of (6)
Year	1955-56
Price	2.95 set



HOOD LOCK SUPPORT PANEL

PART #	DESCRIPTION	YEAR	PRICE
B5A-16717-C	NOS - Limited Supply	1955	139.95 ea.



Carpenter Brand*

- Quality Materials
- Long Lasting
- Exact of original

With over forty-five years of experience Dennis Carpenter is the leading manufacturer and distributor of superior quality Ford weatherstripping and molded rubber parts. Our rubber extrusion department is capable of manufacturing 25,000 feet of specially formulated EPDM rubber to make our quality windshield and rear window seals.

VS.



Competitor Brand*

- Cheap Materials
- Cracks and fades
- Kinda like original

*After 6 months outside in the sun.



SPEEDOMETER CABLE & HOUSING

Part #	A9A-17260
Note	70.25" Long
Year	1949-56
Price	17.95 ea.



SPEEDOMETER CABLE RELATED CLIPS

PART #	PIC	DESCRIPTION	YEAR	PRICE
B9TZ-17264-B	A	Speedometer Cable Retainer to Transmission Clip	57-59	3.95 ea.
B5A-17306-B	B	Speedometer Connector & Spring Clip - From Cable to Head	55-56	9.95 ea.
8A-7713	C	Speedometer Cable to Steering Column Clip w/ Ford-o-Matic Transmission - mounts to steering column	52-53	4.95 ea.



SPEEDOMETER FACES

PART #	PIC	DESCRIPTION	YEAR	PRICE
B5A-17265-A	D		55	34.50 ea.
B7A-10887-E	E		57	49.95 ea.

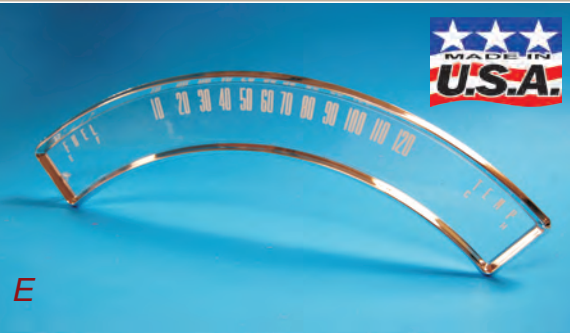

SPEEDOMETER DRIVEN GEAR

PART #	PIC	DESCRIPTION	YEAR	PRICE
B5A-17322-C		19 teeth	52-56	11.95 ea.
B5A-17322-A		20 teeth	52-56	11.95 ea.
B5A-17322-B		21 teeth	52-56	11.95 ea.
B5A-17322-D		22 teeth	52-56	9.95 ea.

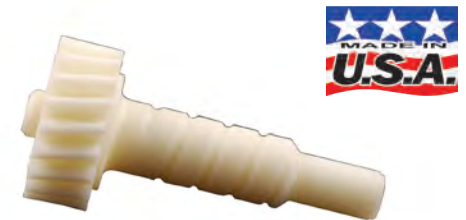

SPEEDOMETER CABLE LUBE

PART #	DESCRIPTION	YEAR	PRICE
B5A-19581-A	Comes in tube	ALL	6.95 ea.

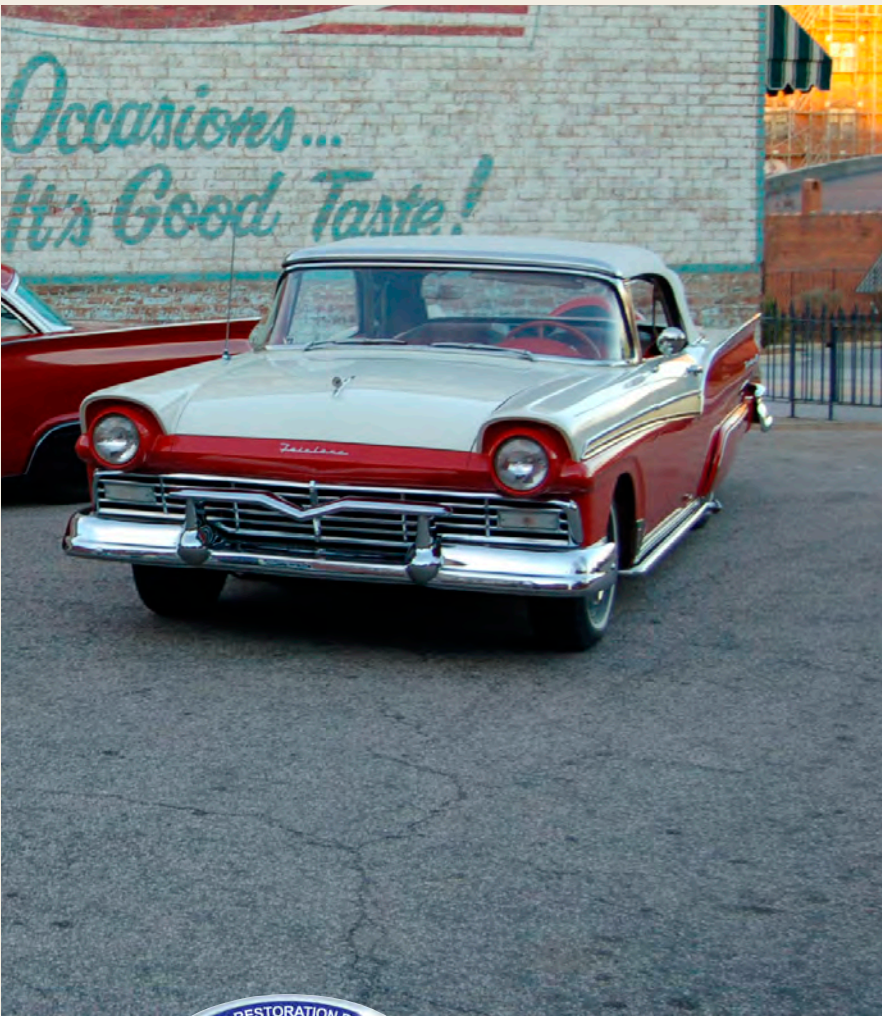

A Snapshot of Dennis Carpenter and His Fords.

Growing up on a farm in Dover, Minnesota, Dennis Carpenter was raised with a strong work ethic and was taught early on how to use machinery and what made it work. Like many young guys he was fascinated with automobiles and by age 12 bought a 1941 Ford for \$12.00. It seemed that first car established an allegiance to Fords that Dennis would carry with him for the rest of his life.

Dennis' passion for Fords and making the parts to restore them has been the driving force at his company since 1970. From the rubber extrusion department comes Premium Line Weather Stripping products. From the stamping and injection dies comes a dynamic variety of Officially Licensed Ford and Original Ford Tooling parts. Passion can be described as "implied energetic and unflagging pursuit of an aim."

Dennis Carpenter's passion is to develop, engineer, and produce superior Ford restoration parts.

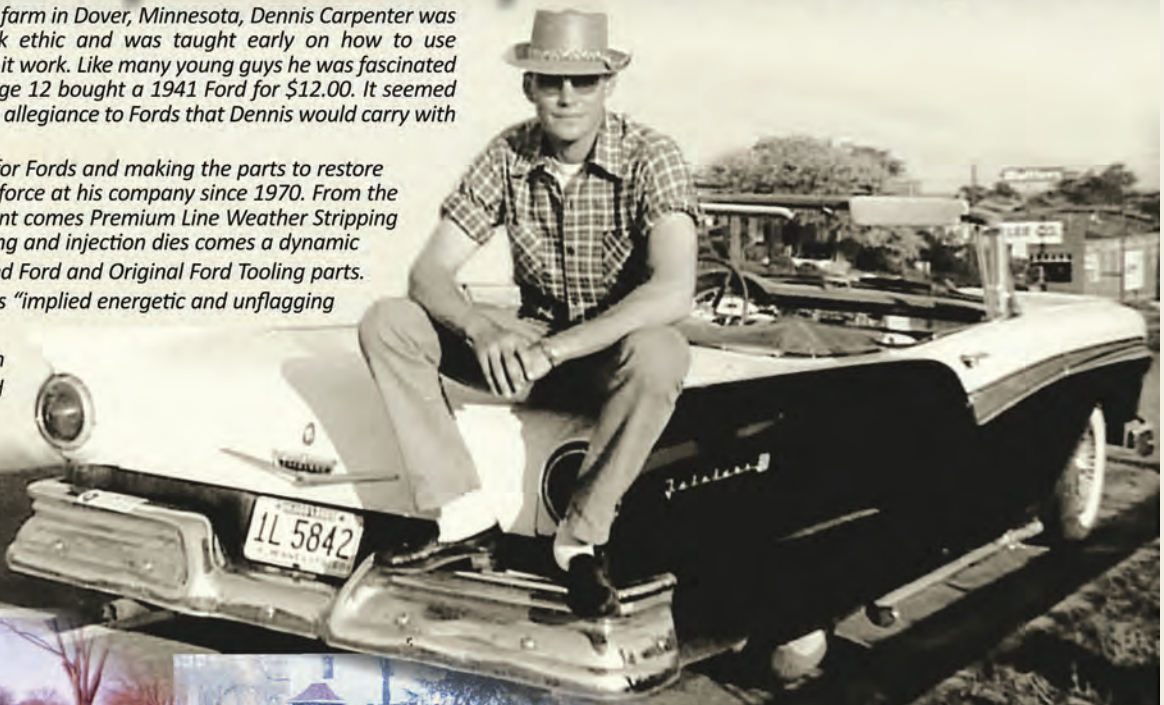

1962
Dennis with his new 1962 Galaxie. Base price was \$3,033.00. He added a push button radio for \$58.50



1960
Dennis in uniform.



1964 Dennis bought this 1956 Police car for \$160. It had a police interceptor engine with a manual transmission.

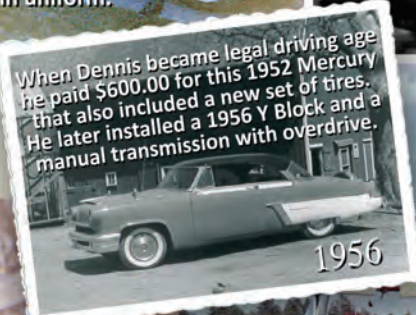

When Dennis became legal driving age he paid \$600.00 for this 1952 Mercury that also included a new set of tires. He later installed a 1956 Y Block and a manual transmission with overdrive.

1956



1960
Dennis paid \$162.50 for this 1936 Ford 5 window coupe.



1961
Dennis' first Galaxie was a beautiful 1961 convertible.



1960
Dennis on Army leave with his 1957 convertible.

1955-56

Electric Wiper Motor Kits are COMING!

ELECTRIC WINDSHIELD MOTOR KIT

Part #	B7A-17508-A
Type	2 speed - 12V
Year	1957
Price	224.95 kit



WIPER ARM TO MOTOR GROMMET

Part #	51A-17562
Note	Rubber - Secures underdash arm to motor
Year	Ford - 1949-56 Mercury - 1952-56
Price	1.95 pr.



WIPER HOSE GROMMET

Part #	BAAA-17545
Note	Goes through Firewall
Year	1953-56
Price	2.95 pr.



WIPER ARMS TO MOTOR CLIP

Part #	BA-17450-A
Note	For Vacuum Motors
Year	1952-56
Price	3.95 ea.



WIPER PIVOT REPAIR KIT

Part #	*8A-17566-RK
Note	Knull Nut Replacement
Year	1949-59
Price	19.95 pr.



WIPER PIVOT SHAFT NUT

Part #	356094-S
Note	Chrome Plated
Year	1949-59
Price	5.95 ea.

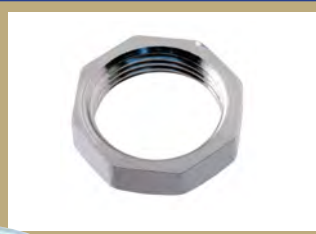

WIPER PIVOT SHAFT BEZEL OR SPACER

PART #	PIC	DESCRIPTION	YEAR	PRICE
BA-17515-A	A	Chrome	52-54	24.95 pr.
B5A-17514-PR	B	Chrome	55-56	24.95 pr.
B7A-17514-PR	C	Chrome	57-58	24.95 pr.
B9A-17514-PR	D	Chrome	59	24.95 pr.

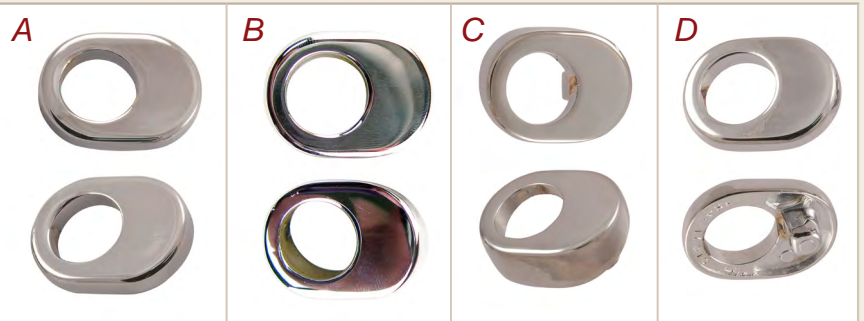

WIPER PIVOT BEZEL TO COWL GASKET

PART #	PIC	DESCRIPTION	YEAR	PRICE
BA-17541	E	Rubber	52-58	3.95 pr.
B9A-17541	F	Rubber	59	3.95 pr.



WIPER HOSE

Part #	99A-17543
Type	1/4" I.D.
Note	Sold by the foot NON RETURNABLE
Year	1932-60
Price	0.95 ft.

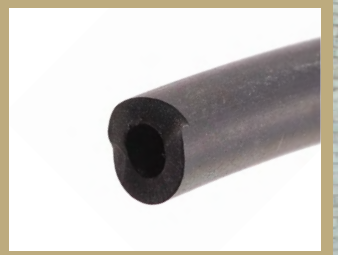

WINDSHIELD WASHER PARTS

PART #	PIC	DESCRIPTION	NOTE	YEAR	PRICE
BM-17618	G	Windshield Washer Reservoir Bag w/ Cap		1955-59	29.95 ea.
BF-17615-A	H	Windshield Washer Toptee Assembly		1954-59	9.95 ea.
BM-17632-A	I	Cap for Washer Reservoir		1954-59	5.95 ea.
8A-17664-RP	J	Washer Rubber Repair Pump	Foot Operated	1949-64	14.95 ea.
BA-17666-A	K	Nozzle Assembly Windsdshield Washer		1952-56	14.95 ea.
8A-17664-P	L	Washer Pedal Pad		1949-64	2.95 ea.
BH-17665-PR	M	Washer Nozzle/Jet Assembly for Wiper Bezel	(2) Jets, (2) Adj. Screws	Mercury 1949-53	39.95 pr.



WIPER ARM - ORIGINAL

PART #	PIC	DESCRIPTION	YEAR	PRICE
BD-17527-A		LH	52-54	14.95 ea.
BD-17526-A	N	RH	52-54	14.95 ea.
B5A-17527-A		LH	55-56	19.95 ea.
B5A-17526-A	O	RH	55-56	19.95 ea.
B7A-17527-A		LH	57-58	19.95 ea.
B7A-17526-A	P	RH	57-58	19.95 ea.
B9A-17527-A		LH	59	19.95 ea.
B9A-17526-A	Q	RH	59	19.95 ea.

WIPER BLADES

PART #	PIC	LENGTH	TYPE	YEAR	PRICE
8A-17528	R	11"	Original	49-54	15.95 ea.
8A-17528	R	11"	Original	49-53 Mercury	15.95 ea.
B5A-17528-A	S	12"	Original	55-58	19.95 ea.
B9A-17528-A		13"	Original	59	19.95 ea.
B2T-17528-A	T		Replacement	55-60	19.95 ea.

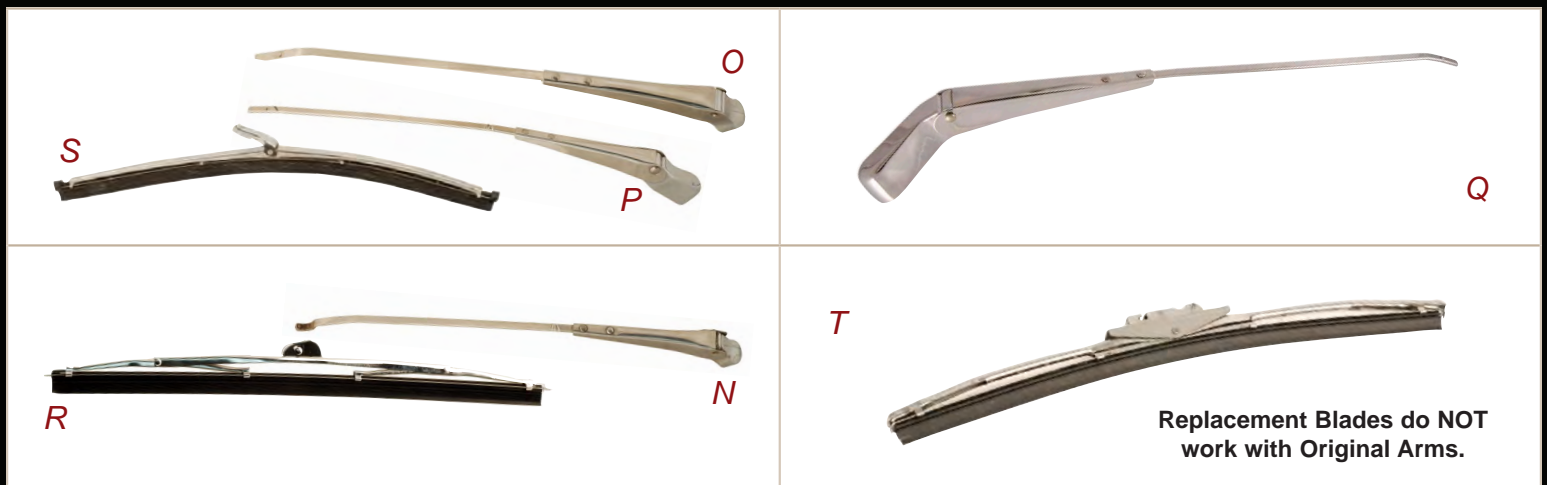

Replacement Blades do NOT work with Original Arms.

FENDER, HOOD, & EXTERIOR → REAR VIEW MIRROR

OUTSIDE REAR VIEW MIRROR

Made in USA - Gaskets are included with Mirrors

Type	With Ford Script
Note	Round Head
Fits	RH or LH
Price	74.95 ea.

B5A-18402	1 Hole - 1952-56
B5A-18402-A	2 Hole - 1955-56



Type	Without Ford Script
Note	Round Head
Fits	RH or LH
Price	59.95 ea.

B6A-17696	1 Hole - Early 1955
B6A-17696-A	2 Hole - 1955-59



Type	Hooded
Note	Square Head
Fits	RH or LH
Price	149.95 ea.

B6A-18402-K	1956-59
-------------	---------



INSIDE REAR VIEW MIRROR

w/ Arm & Installation Bracket
Chrome Plated - Imported
No Hardware

PART #	PIC	DESCRIPTION	YEAR	PRICE
BAAA-17700-B	C	All	52-54	49.95 ea.
B6C-17700-B	D	All Fairlane	55-56	49.95 ea.

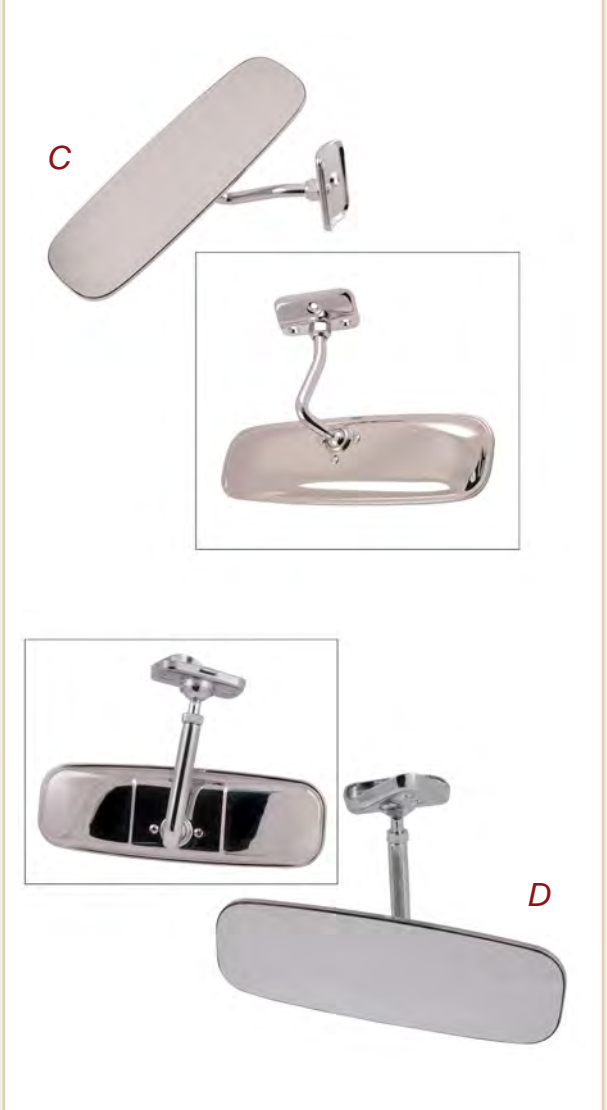

OUTSIDE REAR VIEW MIRROR GASKETS

PART #	PIC	DESCRIPTION	YEAR	PRICE
Made in USA - Gaskets are included with Mirrors				
B5A-17697	A	Paper	55-59	1.95 ea.
B5A-17696-R	B	Rubber	55-59	7.95 ea.

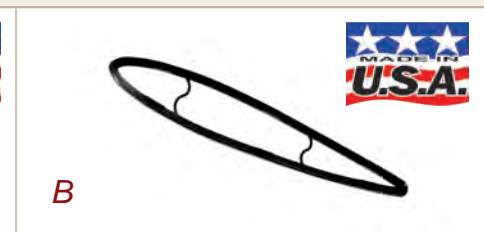

50,000
PART NUMBERS
IN STOCK!
SHOP ONLINE
www.dennis-carpenter.com

FRONT BUMPER STONE DEFLECTORS - NOS

Add \$25.00 For Packaging Charge - LIMITED SUPPLY

PART #	PIC	DESCRIPTION	YEAR	PRICE
BA-17748-D	E	6 cylinder	52-53	100.00 ea.
BM-17748-A	E	8 cylinder	54	150.00 ea.
BM-17748-B	E	6 cylinder	54	100.00 ea.
B9A-17748-A	E	All	59	274.95 ea.

FRONT STONE DEFLECTOR SEAL

PART #	PIC	DESCRIPTION	YEAR	PRICE
B5A-17740	F	Front Stone Deflector to Radiator Seal - 19-3/4"	55-56	4.95 ea.
1A-17749		Front Stone Deflector to Bumper Arm Anti-Rattler	51-55	4.95 pr.
B6A-17749	G	- 2 per.....	56	4.95 pr.

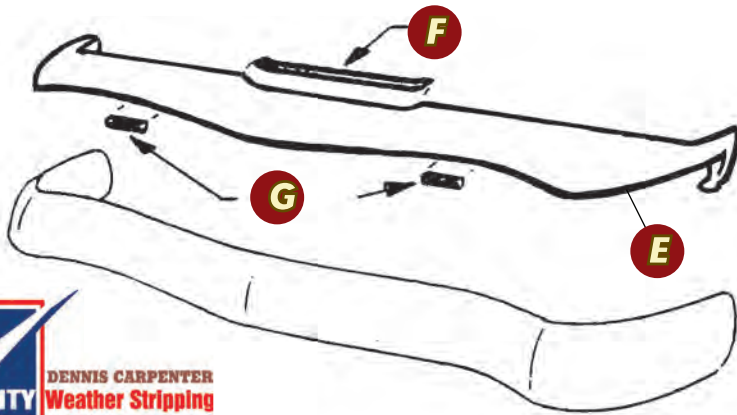

REAR STONE DEFLECTOR SEAL

PART #	PIC	DESCRIPTION	YEAR	PRICE
ALL STONE DEFLECTOR RUBBERS COME WITH STAPLES				
BA-17832-B		Between body & rear bumper	52-54	19.95 ea.
B5A-17832		Between body & rear bumper	55-56	9.95 ea.
B7A-17832	H	All except Retractable	57-58	29.95 ea.
B7A-17832-RT		Retractable Only	57-58	29.95 ea.
B9A-17808-E	I	All	59	34.95 ea.

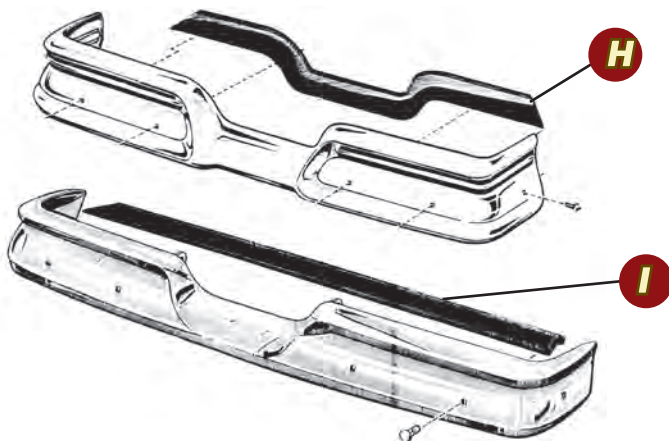

BUMPER BOLTS & WASHER

Part #	B9A-17758
Type	Bumper Bolts Stainless Steel
Note	(4) per front (6) per rear
Year	1949-59
Price	3.50 ea.



Part #	351503-S40
Type	Bumper Bolt Crush Washer
Note	10/12 per Bumper
Year	1959-64
Price	1.95 ea.



BUMPER GUARD BUMPER - RUBBER

Part #	B9A-17088-A
Fits	Front or Rear
Year	1959-64
Price	19.95 pr.

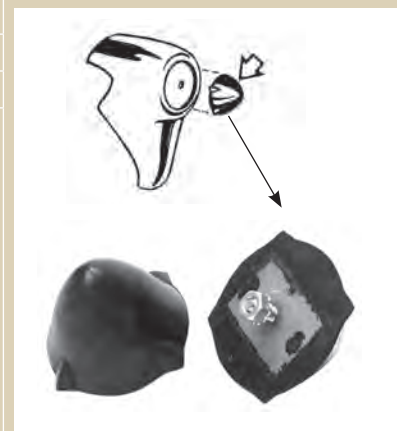

FRONT BUMPER WING GUARD TEMPLATE

PART #	DESCRIPTION	YEAR	PRICE
B7A-17891-T	Template for installing front bumper wing guard	57	1.95 ea.



FRONT MOUNT ANTENNA ASSEMBLY

Includes lead-in wire (wire from radio to antenna), installation instructions & template.



PART #	DESCRIPTION	YEAR	PRICE
B5A-18813-C	Ford Passenger Car	52-56	59.95 ea.
B5A-18813-C	Mercury	52-54	59.95 ea.
B5A-18813-C	Mercury (Inexact fit)	55-56	59.95 ea.

PART #	YEAR	PRICE
B7A-18813-F	1957	89.95 ea.

PART #	YEAR	PRICE
B8A-18813-A	58-59	89.95 ea.



1952-56



1957



1958-59

Antenna Base Pads - FRONT

All Antenna Parts are Included with Kits/Assemblies

PART #	PIC	DESCRIPTION	YEAR	PRICE
BA-18818	A	Front Mount	52-56	4.95 ea.
B7A-18818-S	B	Front Mount	57	5.95 ea.
B8A-18818-S	C	Front Mount	58-59	4.50 ea.

ANTENNA FRONT MOUNT RELATED PARTS

All Antenna Parts are Included with Kits/Assemblies

PART #	PIC	DESCRIPTION	YEAR	PRICE
6A-18815-S	D	Antenna Mast Assembly	ALL	19.95 ea.
B5A-18912-A	E	Antenna Lead-in Grommet	55-67	2.95 ea.
BA-18919-A	F	Antenna Base	52-56	9.95 ea.



A



B



C



D



E



F

REAR MOUNT ANTENNA ASSEMBLY

Includes lead-in wire (wire from radio to antenna), installation instructions & template.



PART #	DESCRIPTION	YEAR	PRICE
B5A-18813-B	Left Rear Quarter Panel Rear Mount	55-56	99.95 ea.

PART #	DESCRIPTION	YEAR	PRICE
B7A-18813-A	Passenger Car & T Bird	57-58	99.95 ea.



1955-56



1957-58

Antenna Base Pads - REAR

All Antenna Parts are Included with Kits/Assemblies

PART #	PIC	DESCRIPTION	YEAR	PRICE
B5A-18818	G	Rear Mount	55-56	6.95 ea.
B7A-18818-AS	H	Rear Mount	57-58	6.50 ea.

G



H



ANTENNA REAR MOUNT RELATED PARTS

All Antenna Parts are Included with Kits/Assemblies

PART #	PIC	DESCRIPTION	YEAR	PRICE
6A-18815-S	D	Antenna Mast Assembly	ALL	19.95 ea.
B5A-18817-S	I	Antenna Lead Wire - 192"	55-58	24.95 ea.

D

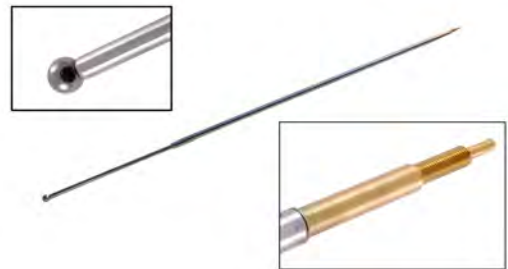

I



\$9.99 *or* **\$14.99** **FLAT RATE SHIPPING**
See shipping page for details.

HEATER MOTOR

PART #	PIC	DESCRIPTION	TYPE	SPEED	YEAR	PRICE
21A-18527-B	A	Universal Heater Motor	6 volt	1 speed	49-55	87.50 ea.
B6C-18527-B	B	Universal Heater Motor	12 volt	1 speed	56	87.50 ea.
B6A-18527-B	C	Universal Heater Motor	12 volt	2 speed	56	119.95 ea.
353789-S	D	Heater Motor Wire Grommet			57-58	0.95 ea.



HEATER CORE

PART #	PIC	DESCRIPTION	YEAR	PRICE
B5A-18476	E	For Fresh Air Heater	52-56	109.95 ea.



ABS HEATER PLENUM

Plastic				
PART #	PIC	DESCRIPTION	YEAR	PRICE
FDK-18471-BP	F	For Fresh Air Heater	52-54	124.95 ea.
B6A-18471-B	G	For Recirculating Heater	55-56	134.95 ea.



HEATER DOOR KNOB

Part #	FAB-19203-A
Type	Black Plastic
Note	For Hot Water Heater
Year	1952-57
Price	7.50 ea.



HEATER DUCT, CLAMP, & GASKETS

PART #	PIC	DESCRIPTION	YEAR	PRICE
Heater Connecting Duct				
*B6A-18489-A	A	Square - 4" Diameter	52-56	22.95 ea.
*B5A-18584-A	B	Round - 4" Diameter	52-56	14.95 ea.
Heater Duct Retainer Clamp Square shaped				
FAA-8725-A	C	Air Duct Retainer Clamp	52-56	3.95 ea.
Heater Gaskets				
BA-18568	D	Housing to Heater Core	52-56	5.95 ea.
B7A-18568	E	Housing to Heater Core (3 pcs)	57-58	14.95 kit
BA-18570	F	Heater to Firewall	52-56	5.95 ea.
FAD-18583		Motor to Housing	52-59	6.95 ea.
B9A-18596		Heater Tube to Firewall	59	3.95 ea.
BA-18688	G	Duct Inlet to Heater Core	52-56	5.95 ea.

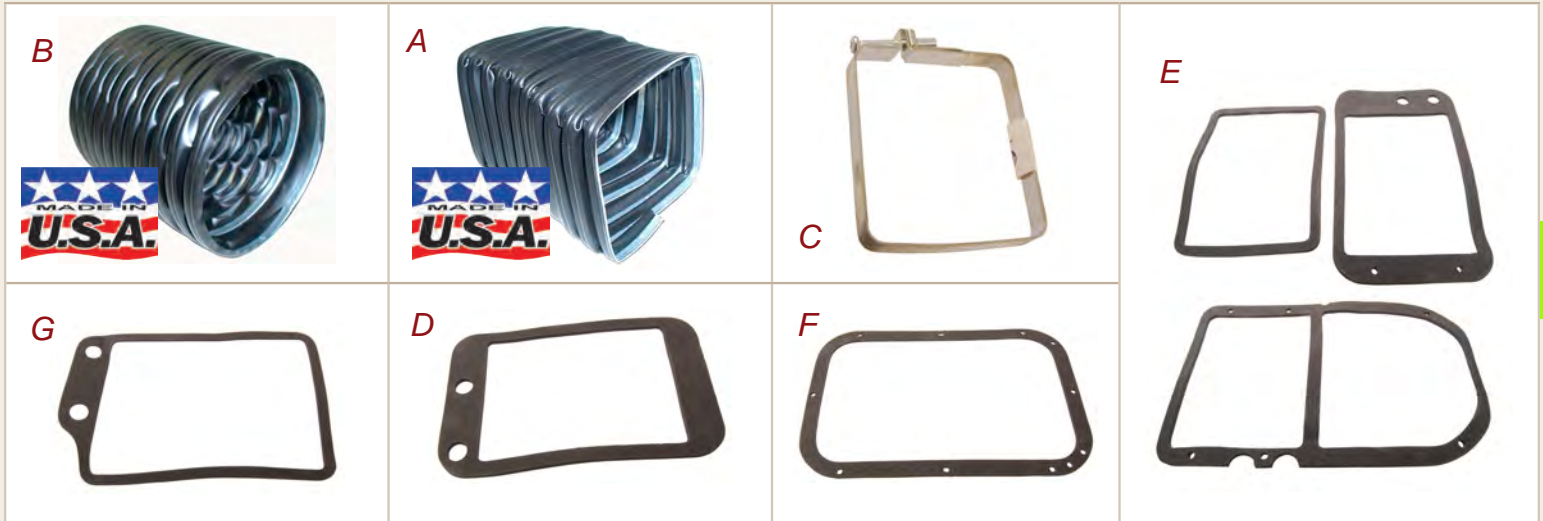
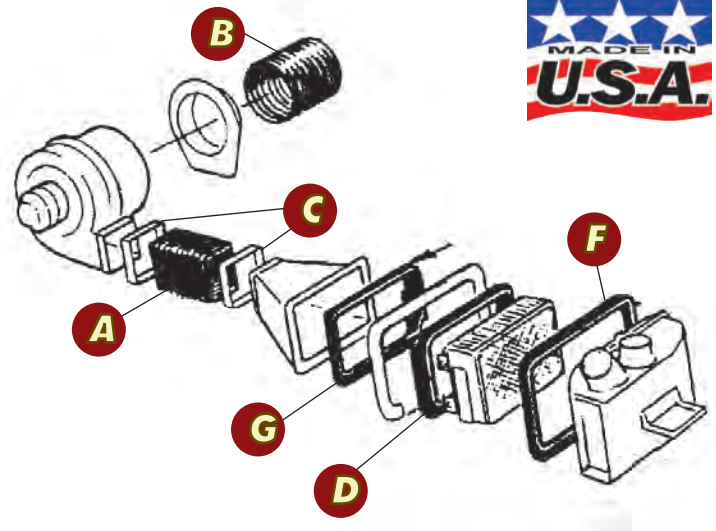

WINDSHIELD DEFROSTER HOSE NOZZEL GASKET

Part #	B7A-18490-SET
Note	(6) pcs.
Year	1957-58
Price	14.95 kit



HEATER PLENUM CHAMBER TO DEFROSTER NOZZLE CONNECTOR

Part #	B7A-19466-A
Year	1957-58
Price	7.95 ea.



HEATER CONTROL VALVE SEAL

Part #	B7A-19460-A
Year	1957-58
Price	4.95 ea.

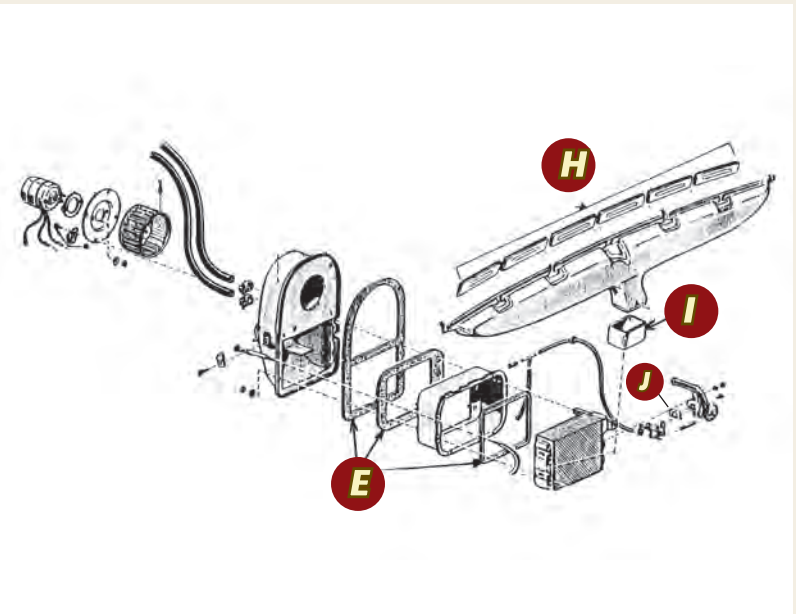

HEATER MOTOR ON/OFF SWITCH

PART #	PIC	DESCRIPTION	YEAR	PRICE
B5A-18578-C	A	NOS - For Fresh Air Heater	55	19.95 ea.
B6A-18578	B	Reproduction - with A/C	56	14.95 ea.
B6A-18578-B		NOS Original Ford - with A/C - Limited Supply	56	45.00 ea.

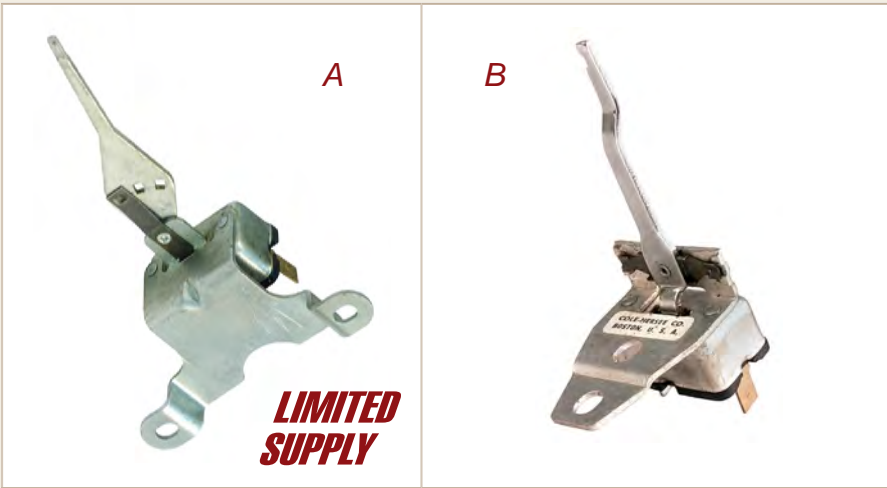

HEATER WIRING

PART #	PIC	DESCRIPTION	YEAR	PRICE
B4AZ-18A627-A	C	Heater Switch to Motor Wire	49-54	15.95 ea.
FEG-19945-A	D	Heater Blower Switch to Motor Wire - A/C only	58	79.95 ea.



HEATER VALVES

Name	Heater Control Valve
Part #	B5A-18495-A
Type	Vacuum type
Note	On motor
Year	1954-56
Price	94.95 ea.



Name	Heater Water Control Valve
Part #	B7A-18495-A
Type	FORD
Year	1957-58
Price	74.95 ea.



Name	Heater Water Control Valve
Part #	FEK-18495-A
Type	MERCURY
Year	1957-58
Price	74.95 ea.



Name	Heater Temperature Regulator Valve w/o A/C
Part #	B7A-18502-A
Note	N.O.S.
Year	1957-58
Price	65.00 ea.



Name	Heater Hose Shut Off Valve
Part #	*91A-15142
Type	Manual
Year	1952-56
Price	19.95 ea.



HEATER & DEFROSTER HOSE

Sold by the foot - Non Returnable

Type	Heater Hose		
APA-18472-A	5/8"	1.95 ft.	
Type	Defroster Hose		
FAB-18556-D	2"	8.95 ft.	
B5A-18556-C	2-1/2"	9.95 ft.	

Heater Hose CLAMP & BRACKET

PART #	PIC	DESCRIPTION	NOTE	YEAR	PRICE
BPA-18572	I	Heater Hose Clamp	5/8"	ALL	1.95 ea.
B7A-10720	J	Heater Hose Bracket		57-58	17.50 ea.



Mounts on Rear of Battery Tray Bolt

SELECT AIR CONDITIONER HEATER PARTS

PART #	PIC	DESCRIPTION	YEAR	PRICE
B7A-19269	E	Evaporator to Firewall Gasket	57	5.95 ea.
B7A-19478	F	Blower Housing to Firewall Gasket	57	9.95 ea.
B7A-19484	G	Blower Motor Mount to Housing Gasket	57-58	3.50 ea.

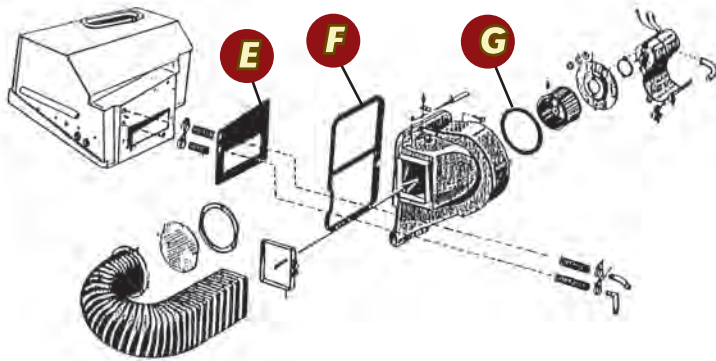

SELECT AIR CONDITIONER EVAPORATOR PARTS

PART #	PIC	DESCRIPTION	YEAR	PRICE
B7A-19227	K	Defroster Nozzle Housing to Garnish Molding Seals	57	6.50 pr.
B7A-19470	L	Evaporator Drain Pan Gasket	57	9.95 ea.
354713-S	M	Evaporator Housing to Hose Grommet - Small hole - (2) per car	57	3.50 ea.
354714-S	N	Evaporator Housing to Hose Grommet - Large hole - (2) per car	57	3.50 ea.
B7A-19268	O	Evaporator to Plenum Chamber Seal	57	32.50 ea.
B7A-19463	P	Connector Assembly Plenum Chamber to Windshield Defroster - A/C Special Bellows - Rubber	57	24.95 ea.

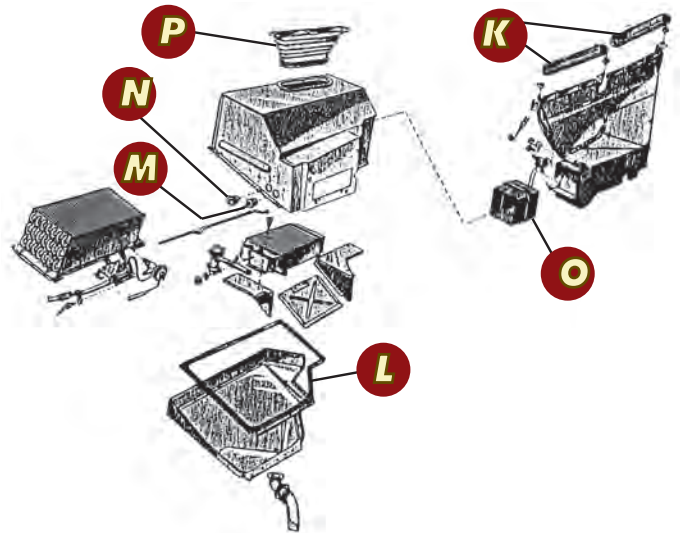

\$9.99 *or* **\$14.99** **FLAT RATE SHIPPING**
See shipping page for details.

AIR CONDITIONER PARTS - 1955-59

PART #	PIC	DESCRIPTION	YEAR	PRICE
B5A-19728-S	A	Drain Hose for Evaporator	55-56	11.95 ea.
354754-S	B	Drain Hose Evaporator Grommet	55-56	3.95 ea.
B5A-19776-S	C	Blower Housing to Dash Outlet Connector Rubber Hose/Elbow		32.50 ea.

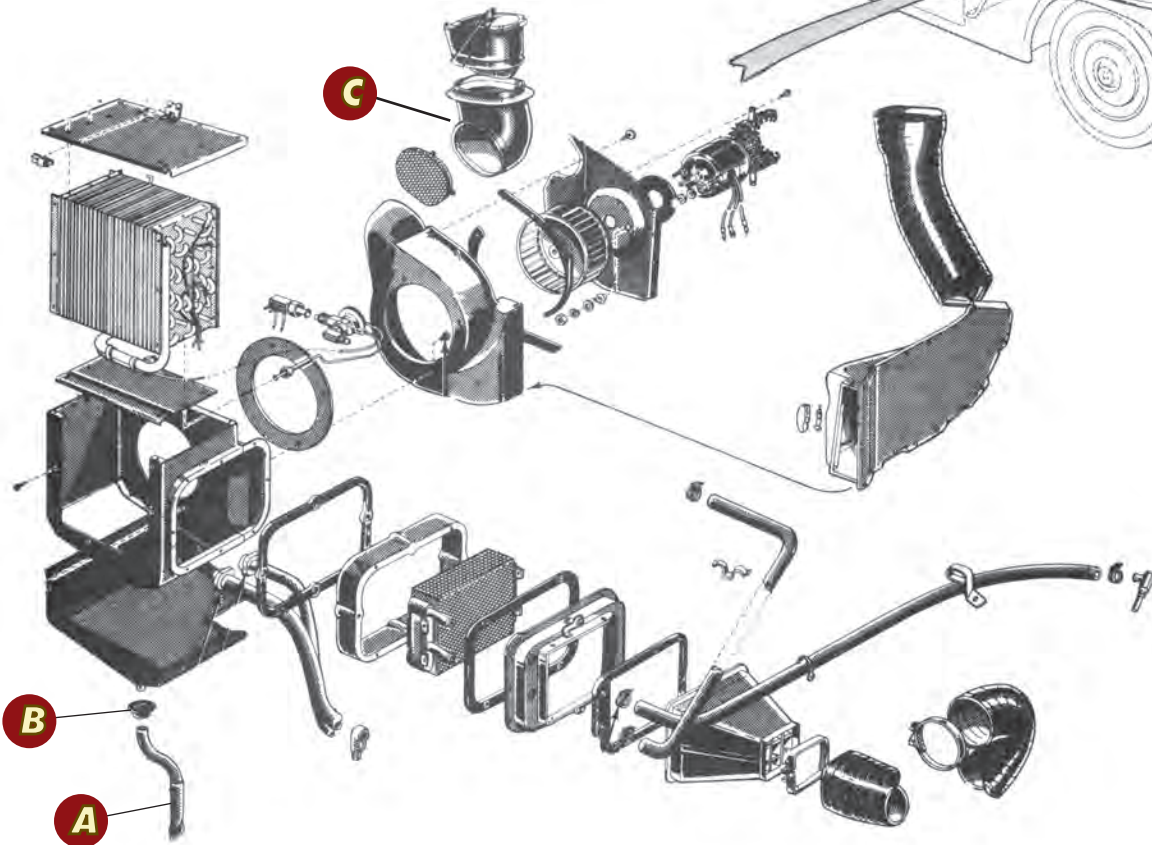
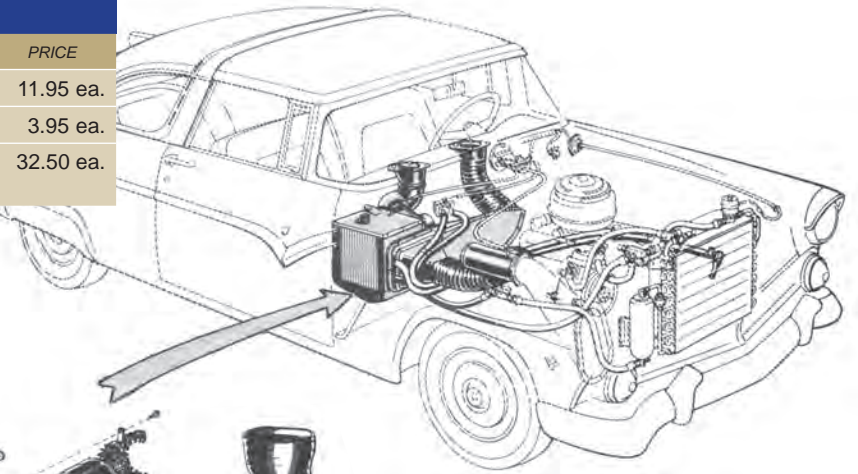

A/C COMPRESSOR GASKET SET

PART #	YEAR	PRICE
B5A-19671-A	1955-56	34.95 set

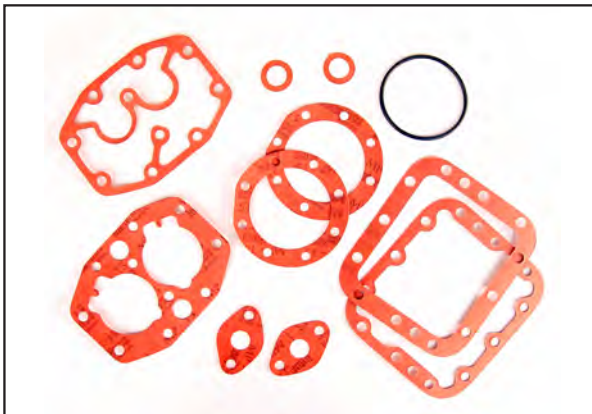

BRUSH & HOLDER ASSEMBLY

PART #	PIC	DESCRIPTION	YEAR	PRICE
B9AE-2979-B	D	- w/ TOP Mounted Hose	58-59	29.95 ea.
C0AE-2979-E	E	- w/ SIDE Mounted Hose	58-59	34.95 ea.



VENTILATOR SYSTEM PARTS - 1952-56

PART #	PIC	DESCRIPTION	NOTE	YEAR	PRICE
BA-16878-A	F	Hood Hinge Assembly to Body Seal		52-54	14.95 pr.
BA-7001878-C	G	Air Duct Ventilator Connector Rubber	Need (2) per car	52-54	14.95 ea.
8A-7001862-S	H	Air Vent Damper Rubber Seal - Must drill out spot welds & reassemble with screws supplied		49-56	14.95 pr.
BA-7001880-A	I	Ventilator Air Valve Gasket	Sold as (1) pair	52-54	7.95 pr.
BA-7001880-A	I	Ventilator Air Valve Gasket	Sold as (2) pair	55-56	7.95 pr.
B5A-7002042-S	J	Air Ventilator Duct Cable to Firewall Grommet	Need (2) per car	55-56	5.95 ea.

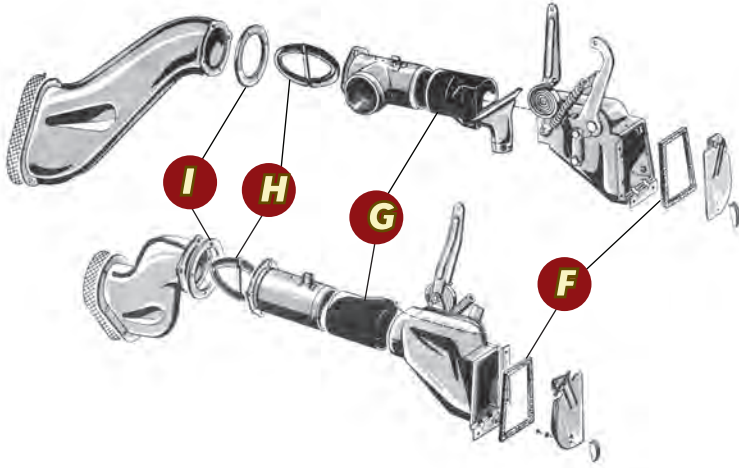

50,000
PART NUMBERS
IN STOCK!
www.dennis-carpenter.com **SHOP ONLINE**

VENTILATOR SYSTEM PARTS - 1957-59

PART #	PIC	DESCRIPTION	YEAR	PRICE
B7A-7001852	K	Ventilator Air Inlet Duct Door to Duct Seal - Inside	57-58	7.95 pr.
B7A-7001862-S	L	Air Vent Damper Rubber Seal	57-58	14.95 pr.
B7A-7001998-B	M	Air Vent Inlet Duct to Heater Seal - Outside	57-59	24.95 pr.

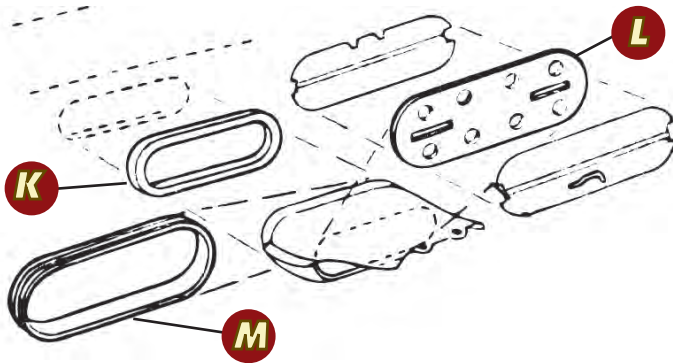

\$9.99 or **\$14.99**
FLAT RATE SHIPPING
See shipping page for details.

FIREWALL COVER & INSULATION

PART #	PIC	DESCRIPTION	YEAR	PRICE
BA-7001670-ABS	A	- ABS Plastic	52-54	259.95 ea.
B5A-7001670-ABS		- ABS Plastic	55-56	274.95 ea.
B7A-7001670-ABS		- ABS Plastic	57-58	249.95 ea.
B9A-7001670-ABS		- ABS Plastic	59	249.95 ea.

A



FIREWALL INSULATOR & CLIPS

PART #	PIC	DESCRIPTION	TYPE	YEAR	PRICE
48-7001670-CLIP	B	Original	Metal	ALL	2.95 ea.
390018-S	C	Replacement	Plastic	ALL	1.95 ea.

B



C



UNDER DASH COWL KICK PANELS

PART #	PIC	DESCRIPTION	NOTE	YEAR	PRICE
B5A-7002341-BL	F	Black		55-56	14.95 pr.
B5A-7002341-G	G	Gray	Can be dyed	55-56	14.95 pr.
B7A-7002341-G	I	Gray	Can be dyed	57-58	14.95 pr.
B7A-7002341-BL	J	Black		57-58	14.95 pr.

WINDSHIELD COWL DRAIN TUBE

Part #	B7A-7002207-A
Year	1957
Price	16.50 pr.



COWL TOP VENTILATOR GRILL ANTI-SQUEAK

PART #	PIC	DESCRIPTION	YEAR	PRICE
B7A-7002204-A	D	U-Shaped	57-59	5.95 kit
B7A-7002286-A	E	Round	57-58	2.50 kit

D



E

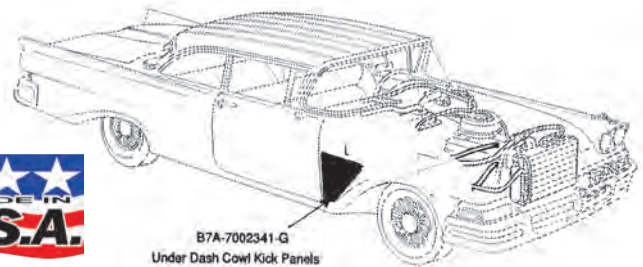

GARNISH MOULDING TO DASH RUBBER

PART #	DESCRIPTION	YEAR	PRICE
BA-7003127-A	82" long	52-55	8.50 ea.
B6A-7003127-A	64" long	56	7.95 ea.
B7A-7003127-B	46" long - To be used w/ A/C	57-58	7.95 ea.
B7A-7003127-E	84" long- For all except A/C	57-58	7.95 ea.
B9A-7003127	86" long	59	7.95 ea.

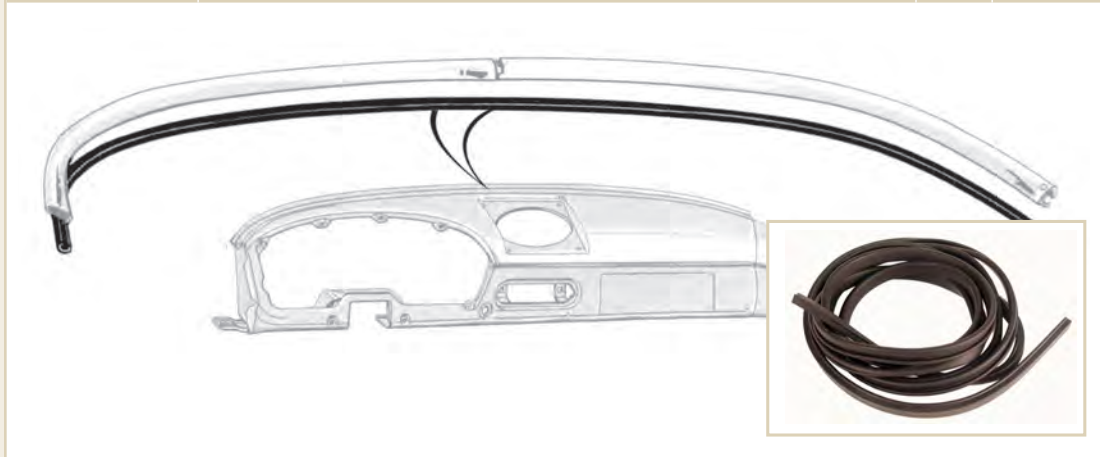

PADDED DASH

PART #	DESCRIPTION	YEAR	PRICE
B7A-4004290-BL	Black	57-58	424.95 ea.
B9A-4004290-BL	Black - For Dyeing	59	424.95 ea.

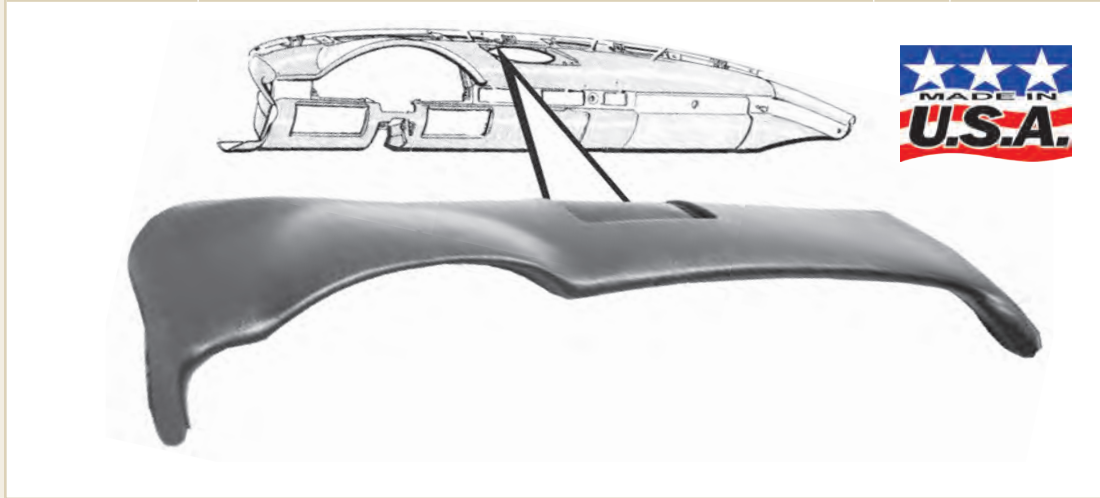

DASH TO COWL SEALS

PART #	PIC	DESCRIPTION	YEAR	PRICE
B6A-6404336-PR		On sides	56	24.95 pr.

COWL & FLOOR PAN PLUGS

352291-S 1.95 ea.



3/4"
diameter hole

377949-S 0.95 ea.



7/8"
diameter hole

377678-S 1.95 ea.



1"
diameter hole

352284-S 1.95 ea.



1 1/4"
diameter hole

352285-S 2.95 ea.



1 1/2"
diameter hole

357216-S 2.95 ea.



1.87"

\$9.99 *or* **\$14.99** **FLAT RATE SHIPPING**
See shipping page for details.

**Sunvisor - CARDBOARD
Gray - RH or LH**

PART #	PIC	FITS	YEAR	PRICE
BA-7004104-A	A	#70,72,73 Sedan	52	24.95 ea.
BF-7004104-A	B	#70,72,73 Sedan	53	24.95 ea.

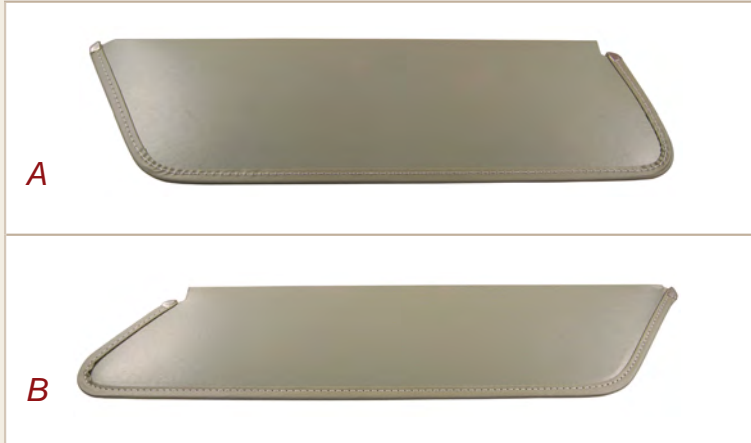

**Sunvisor - PADDED
Off White - To be Dyed**

PART #	PIC	FITS	YEAR	PRICE
B6A-7004104-PR	C	All ex. Hardtop & Convertible	56	94.95 pr.
B6A-6404104-PR	D	Victoria, Conv.& Crown Victoria	56	94.95 pr.
B8A-7604104-PR	E	All except Retractable & Conv.	57-58	94.95 pr.
B7A-7604104-PR	F	Convertible Only	57-58	94.95 pr.
B9A-7604104-PR	G	Convertible	59	194.95 pr.

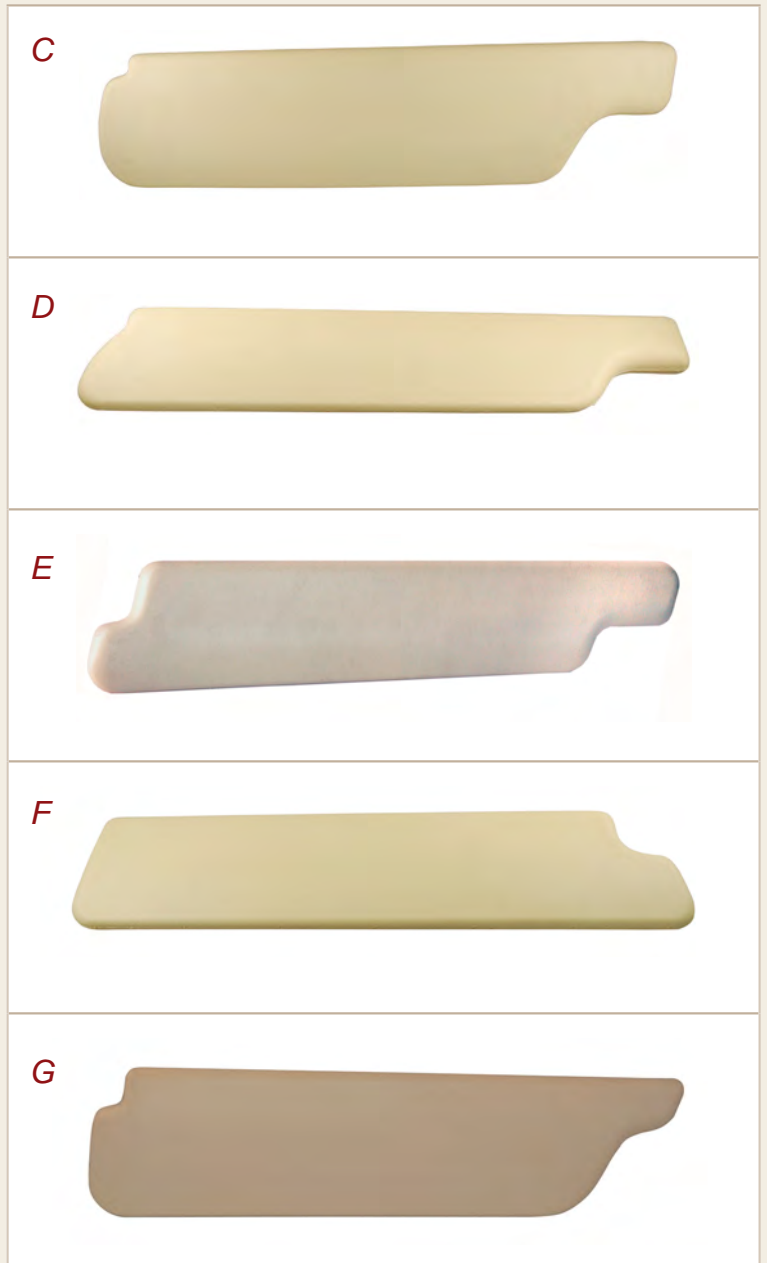

50,000 PART NUMBERS IN STOCK!

SHOP ONLINE

www.dennis-carpenter.com



SUNVISOR ARM & BRACKET

PART #	PIC	SIDE	TYPE	YEAR	PRICE
--------	-----	------	------	------	-------

**Sunvisor Arm & Bracket
FORD - PLAIN**

BA-7604144-BP	A1	RH	Convertible	52-54	49.95 ea.
BA-7604145-BP		LH	Convertible	52-54	49.95 ea.
B6A-7604144-BP	B1	RH	Convertible	55-56	49.95 ea.
B6A-7604145-BP		LH	Convertible	55-56	49.95 ea.
B7A-7604144-AP	C1	RH	Convertible	57-58	34.95 ea.
B7A-7604145-AP		LH	Convertible	57-58	34.95 ea.
B7A-5104144-AP	D1	RH	Retractable	57-58	59.95 ea.
B7A-5104145-AP		LH	Retractable	57-58	59.95 ea.

**Sunvisor Arm & Bracket
FORD - CHROME**

BA-7604144-CC	A2	RH	Convertible	52-54	59.95 ea.
BA-7604145-CC		LH	Convertible	52-54	59.95 ea.
B6A-7604144-CC	B2	RH	Convertible	55-56	59.95 ea.
B6A-7604145-CC		LH	Convertible	55-56	59.95 ea.
B7A-7604144-CC	C2	RH	Convertible	57-58	49.95 ea.
B7A-7604145-CC		LH	Convertible	57-58	49.95 ea.
B7A-5104144-C	D2	RH	Retractable	57-58	74.95 ea.
B7A-5104145-C		LH	Retractable	57-58	74.95 ea.

**Sunvisor Arm & Bracket
MERCURY - CHROME**

BC-7604144-D	E2	RH	Convertible	52-54	59.95 ea.
BC-7604145-D		LH	Convertible	52-54	59.95 ea.
B5A-7604144-A	F1	RH	Convertible	55-56	59.95 ea.
B5A-7604145-A		LH	Convertible	55-56	59.95 ea.

**Sunvisor Arm & Bracket
MERCURY - PLAIN**

B5A-7604144-BP	F2	RH	Convertible	55-56	49.95 ea.
B5A-7604145-BP		LH	Convertible	55-56	49.95 ea.

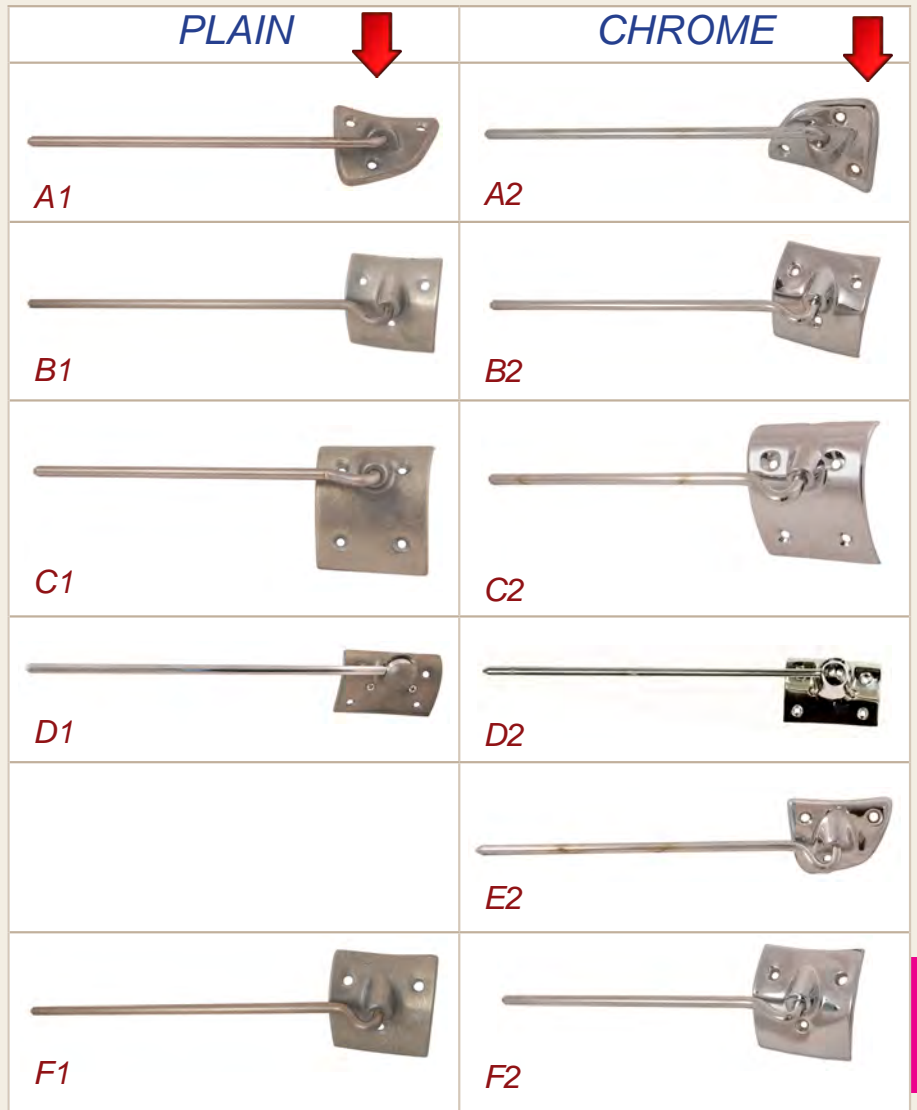

SUNVISOR CENTER MOUNT PIN

Part #	BC-7604114-B
Type	2 1/8" long - 2 per car
Note	Chrome - Goes center end of sun visor
Fits	Mercury Conv. Only
Year	1952-56
Price	5.95 ea.



SUNVISOR ANCHOR PIN

Part #	B8A-7004114-A
Note	Grey Plastic - 2 per car
Year	1958-59
Price	4.95 ea.



**SUNVISOR CLIP PIN
Grey Plastic**

PART #	PIC	DESCRIPTION	YEAR	PRICE
B8A-7004132-A	H	Except Ret. & Convertible	58	14.95 ea.
B9A-5704132-A	I	Except Ret. & Convertible	59	14.95 ea.



SUNVISOR ARM CLIP ASSEMBLY

Part #	BC-7604131-A
Type	Brass Casting
Note	Takes 2
Fits	Mercury - Convertible
Year	1952-54
Price	49.95 pr.



GLOVE BOX EMBLEMS

No Fasteners

PART #	PIC	DESCRIPTION	YEAR	PRICE
B5A-7004460-A	A	Ford Script	55-56	39.95 ea.
B6A-7004407-A	B	Ford V-8 Emblem	55-56	19.95 ea.
B7A-7004407-A	C	Push Button Emblem	57-59	24.95 ea.



GLOVE BOX GROMMETS & BUMPERS

FORD

PART #	PIC	DESCRIPTION	YEAR	PRICE
8A-7006122	D	Glove Box Check Arm Grommet	49-55	2.50 ea.
B7A-7006122	E	Glove Box Door Check Arm Stop Bumper	56-68	1.95 ea.
0A-16378	F	Glove Box Door Bumpers	52-59	2.95 pr.



GLOVE BOX DOOR LOCK & CYLINDER

Each contain (2) keys.

PART #	PIC	DESCRIPTION	YEAR	PRICE
BA-7006081-C		Replacement	52-54	24.95 ea.
B9A-6406081-A	G	Mercury Keys	57-64	24.95 ea.
B8F-6406081-A	H	NOS - Mercury	57-58	19.95 ea.
B9A-6406081-A	G		59	24.95 ea.



GLOVE BOX LINERS

Mounting clips already installed. Includes mounting screws.

PART #	PIC	DESCRIPTION	YEAR	PRICE
BA-7006010-A	I		52-53	24.95 ea.
*BC-7006010	J	Mercury	52-54	24.95 ea.
BM-7006010-A	K		54	24.95 ea.
B5A-7006010-A	L		55	24.95 ea.
B6A-7006010-A	M		56	24.95 ea.
B7A-7006010-A	N	All except w/ Air	57-58	24.95 ea.
B9A-7006010-A	O	All	59	24.95 ea.
B5A-7006010-CC	P	For Factory Air Only	55	24.95 ea.
B6A-7006010-CC	Q	For Factory Air Only	56	24.95 ea.
B7A-7006010-CC	R	For Factory Air Only	57-58	24.95 ea.

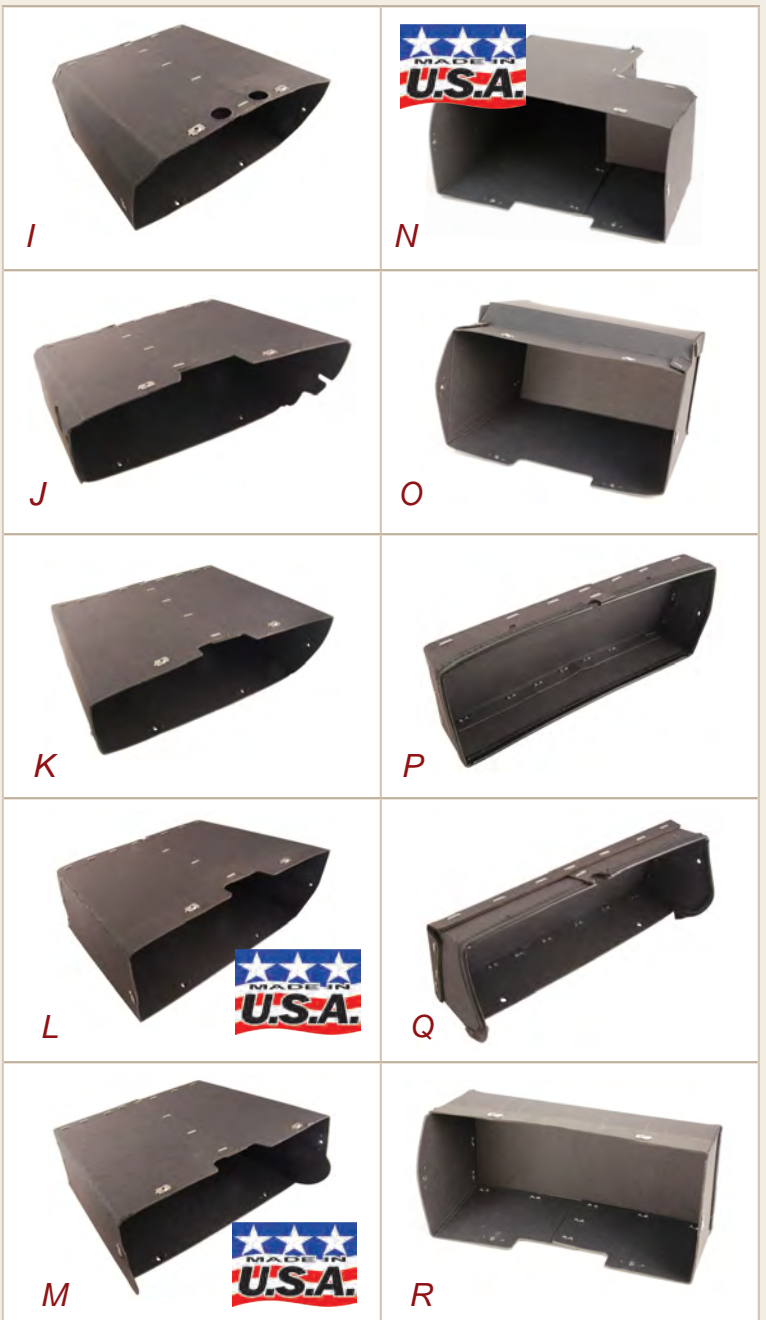

GLOVE COMPARTMENT & INSTRUMENT PANEL BULBS

PART #	PIC	DESCRIPTION	TYPE	YEAR	PRICE
78-13466-55	S	Glove Compartment	6 volt	49-55	1.50 ea.
B6A-13466-57	T	Glove Compartment	12 volt	56	0.95 ea.
78-13466-55	S	Instrument Panel	6 volt	48-55	1.50 ea.
B6A-13466-57	T	Instrument Panel	12 volt	56-59	0.95 ea.



ASH TRAY Door Bumper

Part #	359422-S	
Year	1957-59	
Price	2.50 pr.	

INSTRUMENT CLUSTER LENS SEAL KIT

Part #	B6A-17248-S	
Year	1956	
Price	6.95 kit	

INSTRUMENT PANEL TO DASH GASKET

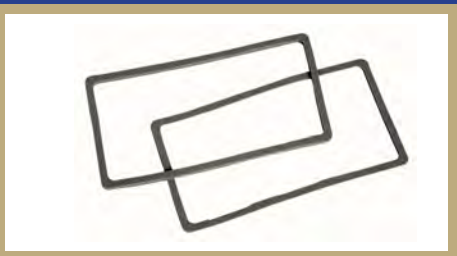
Part #	B8A-11628-S	
Year	1957-58	
Price	7.95 pr.	

SPEEDOMETER FACE DIAL

PART #	PIC	DESCRIPTION	YEAR	PRICE
B5A-17265-A	U	Speedometer Face Dial	55-56	34.50 ea.
B7A-10887-E	V	Speedometer Face Dial	57	49.95 ea.



INSTRUMENT FACES

Made in USA in our Shop!

Part #	B7A-10896-B	
Type	Odometer Bezel	
Year	1957	
Price	14.95 ea	
Part #	B7A-15805-A	
Type	Shift Indicator Dial	
Note	Auto Tran.	
Year	1957	
Price	12.50 ea.	

INSTRUMENT FACE SETS

Made in USA in our Shop!

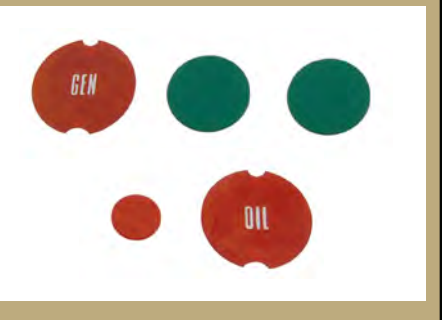
Part #	B7A-10887-SET	
Type	Instrument Cluster Dial Set	
Note	Includes: (1) B7A-10887-E (1) B7A10896-B (1) B7A-15805-A	
Year	1957	
Price	69.95 ea.	
Part #	B7AZ-10A936-SET	
Type	Instrument Warning Lens Set	
Note	Includes: (1) generator (red) (1) oil (red) (2) turn signal (green) (1) high beam (red)	
Year	1957	
Price	14.95 set	

50,000
PART NUMBERS
IN STOCK!

SHOP ONLINE

www.dennis-carpenter.com



1957

DASH KNOBS

BLACK with SILVER INSERTS (where applicable)

PART #	PIC	KNOB TYPE	PRICE
B7A-11661-B	7A	Headlight Switch (w/ Shaft)	8.95 ea.
B7A-7001890-B	7B	Air Vent Knob	6.95 ea.
B7A-17513-B	7C	Windshield Wiper On/Off Switch	6.95 ea.
B7A-7023352-A	7D	Window Crank Handle	5.95 ea.
B7A-15052-B	7E	Cigar Lighter	5.95 ea.
B7A-18513-A	7F	Heater Blower Switch	5.95 ea.
B7A-18519-A	7G	Heater Temp. & Regulator Control	5.95 ea.
B7A-18805	7H	Radio	6.95 ea.
B7A-7213-B	7I	Gear Shift	5.95 ea.
B7A-13305-B	7J	Turn Signal Lever	5.95 ea.



7B Need (2) per car

7C

7D Includes installation pin

7A

7E

7F

7G Need (2) per car

7H Need (2) per car

7I

7J



1958

DASH KNOBS

WHITE with GOLD INSERTS (where applicable)

PART #	PIC	DESCRIPTION	PRICE
B8A-11661-A	8A	Headlight Switch (w/ Shaft)	8.95 ea.
B8A-7001890-A	8B	Air Vent	6.95 ea.
B8A-17513-A	8C	Windshield Wiper On/Off Switch	6.95 ea.
B8A-7023352-A	8D	Window Crank Handle	5.95 ea.
B8A-15052-A	8E	Cigar Lighter	5.95 ea.
B8A-18513-A	8F	Heater Blower Switch	5.95 ea.
B8A-18519-A	8G	Heater Temp. & Regulator	5.95 ea.
B8A-18805	8H	Radio	6.95 ea.
B8A-7213-W	8I	Gear Shift	5.95 ea.
B8A-13305-W	8J	Turn Signal Lever	5.95 ea.



8B Need (2) per car

8C

8D Includes installation pin

8A

8E

8F

8G Need (2) per car

8H Need (2) per car

8I

8J



DASH KNOBS
WHITE with SILVER INSERTS (where applicable)

PART #	PIC	DESCRIPTION	PRICE
B9A-11661-A	9A	Headlight Switch (w/ Shaft)	8.95 ea.
B9A-6301890-A	9B	Air Vent	6.95 ea.
B9A-17513-A	9C	Windshield Wiper On/Off Switch	6.95 ea.
B8A-7023352-A	9D	Window Crank Handle	5.95 ea.
B9A-15052-A	9E	Cigar Lighter	5.95 ea.
B8A-18513-A	9F	Heater Blower Switch	5.95 ea.
B8A-18519-A	9G	Heater Temp. & Regulator Control	5.95 ea.
B9A-18805	9H	Radio	6.95 ea.
B8A-7213-W	9I	Gear Shift	5.95 ea.
B8A-13305-W	9J	Turn Signal Lever	5.95 ea.



INSTRUMENT PANEL WIRING

Part #	FAB-9272-A
Name	Instrument Cluster Wire
Type	FORD
Fits	Goes from Ignition Switch to Oil, Fuel, & Temperature Gauges
Year	1952-53
Price	8.95 ea.



Part #	FAB-9272-C
Type	Instrument Cluster Wire
Note	MERCURY
Fits	Goes from Dash Wiring to High Beam & Oil, Fuel, & Temperature Gauges
Year	1952-53
Price	29.95 ea.



Part #	FDC-9272-B
Name	Instrument Cluster Wire
Type	MERCURY
Fits	Goes from Dash Wiring & Ignition Switch to Oil, Fuel, & Temp. Gauges
Year	1954
Price	29.95 ea.



Part #	B6A-14444
Type	Dash Panel Light Bulb Wiring & Socket Assembly
Year	1956-59
Price	9.95 ea.



Part #	B7A-15026-B
Name	Electric Clock Feed Wire with Fuse Holder
Year	1957-58
Price	49.95 ea.



Part #	B9A-14289-C
Name	Dash to Engine Gauge Feed Wire
Type	8 cylinder
Year	1959
Price	99.95 ea.



SCUFF PLATES

Manufactured exactly as Original in our Shop.
Complete with Installation Screws.



PART #	PIC	FITS	TYPE	YEAR	PRICE
Scuff Plates					
2-Door					
BA-7013208-PR	A	All	2-Door	52-54	114.95 pr.
B5A-7013208-PR	B	All	2-Door	55-56	114.95 pr.
B7A-7013208-PR		All	2-Door	57-58	114.95 pr.
B9A-7013208-PR		All	2-Door	59	114.95 pr.

Scuff Plates					
4-Door FRONT					
BA-7313208-PR		All 4-Dr.	4-Door Front	52-54	114.95 pr.
B5A-7313208-PR		All 4-Dr. Sedan	4-Door Front	55-56	114.95 pr.
B7A-7313208-PR		#73 4-Dr. Sedan	4-Door Front	57-58	114.95 pr.
B7A-7313208-PR		#79 4-Dr. Station wagon	4-Door Front	57-58	114.95 pr.
B7A-5813208-PR		#57 4-Dr. Hardtop	4-Door Front	57-58	114.95 pr.
B7A-5813208-PR		#58 4-Dr. Hardtop with post	4-Door Front	57-58	114.95 pr.
B9A-7313208-PR		All 4-Dr.	4-Door Front	59	114.95 pr.

Scuff Plates					
4-Door REAR					
BA-7313228-PR		All 4-Dr.	4-Door Rear	52-54	114.95 pr.
B5A-7313228-PR		All 4-Dr. Sedan	4-Door Rear	55-56	114.95 pr.
B7A-7313228-PR		#73 4-Dr. Sedan	4-Door Rear	57-58	114.95 pr.
B7A-5813228-PR	C	#57 4-Dr. Hardtop	4-Door Rear	57-58	114.95 pr.
B7A-5813228-PR	C	#58 4-Dr. Hardtop with post	4-Door Rear	57-58	114.95 pr.
B7A-7913228-PR		#79 4-Dr. Station wagon	4-Door Rear	57-58	114.95 pr.
B9A-7313228-PR		All 4-Dr.	4-Door Rear	59	114.95 pr.

Scuff Plates					
MERCURY - 2 & 4 Door					
BM-7013208-PR	D	All	2-Door	52-54	149.95 pr.
BM-7313208-PR		All 4-Dr.	4-Door Front	52-54	149.95 pr.
BM-7313228-PR		All 4-Dr.	4-Door Rear	52-54	149.95 pr.

FLOOR MAT
FRONT - BLACK RUBBER
Ford or Mercury

PART #	YEAR	PRICE
*BA-7013000	52-54	119.95 ea.
*B5A-7013000	55-56	139.95 ea.
B7A-7013000	57-59	139.95 ea.

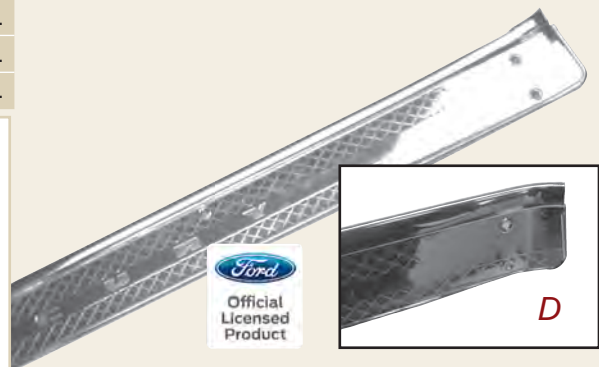
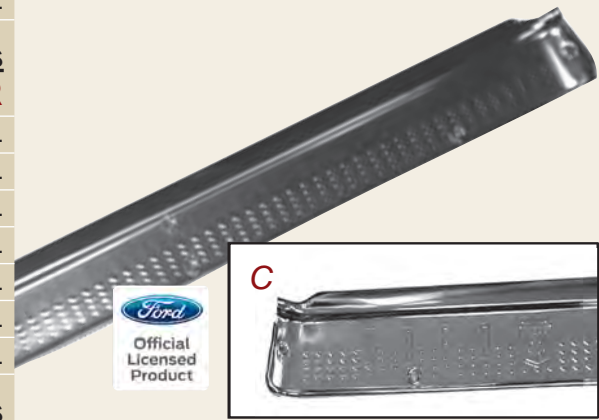
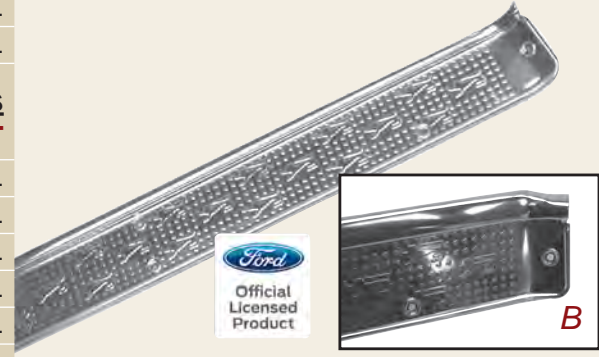
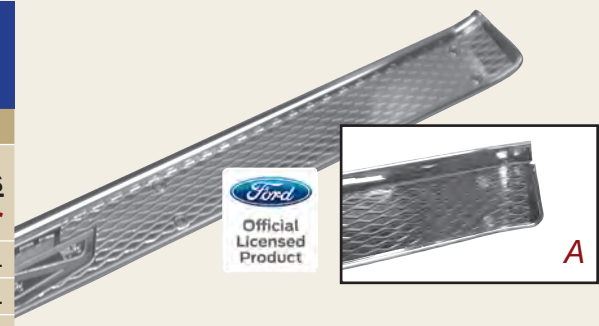
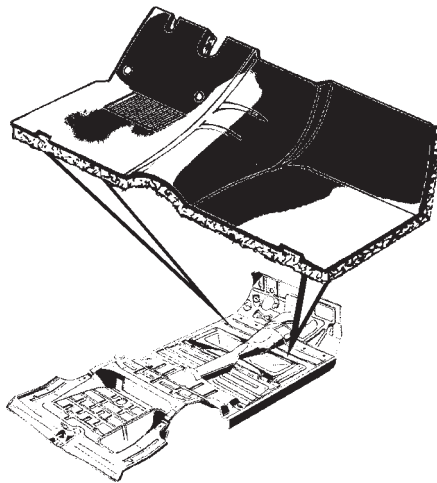

All 52-59
SCUFF PLATES
are **MADE IN U.S.A.**

ROCKER PANEL MOULDING SETS

Clips not included in moulding sets. Sold separately.

Rocker Panel Moulding Set	
Part #	B5A-7010176-PR
Type	w/ clips & template
Note	(2) door only
Year	1955-56
Price	499.95 set



Clips are Included with Moulding Set

Rocker Panel Moulding Set	
Part #	B7A-7010176-PR
Note	w/ Hockey Sticks & Clips - (4) pcs.
Year	1957-58
Price	524.95 set



Clips are Included with Moulding Set



Set of 18

Rocker Molding Clip Set	
Part #	B7A-7010182-SET
Note	Set of (18)
Year	1957-58
Price	71.95 set

Rocker Panel Moulding Set	
Part #	B9AB-6410176-PR
Note	Includes Clips
Year	1959
Price	499.95 set



Clips are Included with Moulding Set



Set of 10

Rocker Molding Clip Set	
Part #	B9A-7010182-SET
Note	Set of (10) clips
Year	1959
Price	39.95 set

ROCKER PANELS

PART #	PIC	DESCRIPTION	YEAR	PRICE
BA-7010130-PR		2-dr	52-54	79.95 pr.
BA-7310130-PR		4-dr	52-54	84.95 pr.
B5A-7010130-PR		2-dr	55-56	79.95 pr.
B5A-7310130-PR		4-dr	55-56	84.95 pr.
B7A-7010130-PR	F	2-dr.	57-58	79.95 pr.
B9A-7010130-PR		2-dr.	59	79.95 pr.
B7A-7310130-PR		4-dr. Custom Series	57-58	84.95 pr.
B7A-5810130-PR		4-dr. Fairlane Series	57-58	119.95 pr.
B9A-7310130-PR		4-dr.	59	84.95 pr.

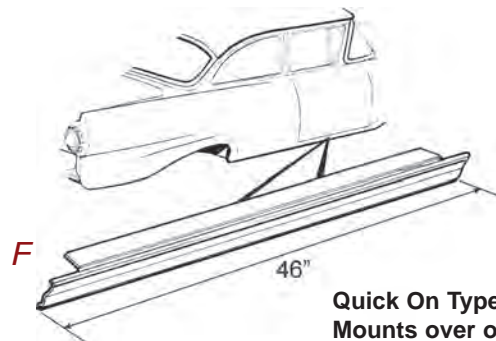

Quick On Type - Ford & Mercury Mounts over old rocker panel.

What you should know about Dennis Carpenter Weather Stripping.

(It's the last one you'll ever have to replace.)



**CARPENTER
MADE**

PREMIUMLINE
WEATHER STRIPPING
by Dennis Carpenter



Made Right, Fits Right, Lasts Longer

4140 Concord Parkway South Concord, North Carolina 28027 U.S.A. PH. 704.786.8139 800.476.9653 EMAIL: info@dennis-carpenter.com



1. WE MAKE IT.

Designed, Engineered and Manufactured by Dennis Carpenter.

Our rubber extrusion department is capable manufacturing 15,000 feet daily of specially formulated EPDM rubber to make our quality windshield and rear window seals. We use the same machinery to extrude thousands of feet of soft sponge rubber which is an integral component of producing our door, roof rail and trunk seals. With over forty-five years of experience Dennis Carpenter is the leading manufacturer and distributor of superior quality Ford weatherstripping and molded rubber parts.



Over 99% of our Dennis Carpenter Weather Stripping is made right here in Concord, NC, USA. We are proud to be the largest manufacturer of Ford Restoration parts made in the United States.



2. IT'S THE VERY BEST.

Why is Dennis Carpenter WEATHER STRIPPING the absolute best on the market?

Combine 45 plus years of manufacturing experience with 60 durometer E.P.D.M. dense rubber compound and you get a rear window seal that not only holds 50 lbs. of safety glass in place but better resists drying and shrinking from the sun's harmful ultraviolet rays.

At Dennis Carpenter Reproductions beginning with quality ingredients is the secret to making quality weather stripping products. Our attention to detail and quality control ensures that you're getting a premium product that is the absolute best on the market.



Competitor Brand

- Cheap Materials
- Cracks and fades



Carpenter Brand

after 6 months in our testing laboratory (Outside exposed to the elements)



- Made exact of original
- Quality Materials
- Long Lasting



Ours

• Exact fit and mold

• Made kinda like original

Theirs



WINDSHIELD POST TO DOOR SEAL

PART #	PIC	DESCRIPTION	YEAR	PRICE
BA-7602626-PR B5A-6002626-A		Windshield Post to Door Seal - Convertible - Crown & Hardtop	52-54 55-56	34.50 pr. 9.95 pr.
B5A-7603198-PR		Windshield Post to Door Seal Special Weatherstrip that goes up windshield post & across top - Convertible Only	55-56	39.95 pr.
B7A-7603198-PR B9A-5103198-PR		Windshield Post to Door Seal - Conv. & Retractable - Conv. & Retractable	57-58 59	19.95 pr. 49.95 pr.



WINDSHIELD SEALS - FORD - 52-54

PART #	DESCRIPTION	YEAR	PRICE
Mfg. USA in our Shop			
BA-7603110-D	Windshield Rubber Seal with Groove for Chrome #60B Crestline Victoria #60F Crestline Skyliner #76B Crestline Convertible	52-54 54 52-54	69.95 ea.
BA-7003110-E	Windshield Rubber Seal Without Groove for Chrome Molding Except Across Bottom #59A Mainline "Ranch Wagon" #70A Mainline 2-Door Sedan #72C Mainline Business Coupe #73A Mainline 4-Door Sedan #78A Sedan Delivery "Courier"	52-54 52-54 52-54 52-54 52-54	69.95 ea.
BA-7003110-F	Windshield Rubber Seal With Groove for Chrome #70B Customline 2-Door Sedan #72B Customline Club Coupe #73B Customline 4-Door Sedan #73C Crestline 4-Door Sedan #79B Customline Wagon Country Sedan #79C Crestline Wagon Country Sedan #59B Customline Ranch Wagon	52-54 52-54 52-54 54 52-54 52-54 54	69.95 ea.

WINDSHIELD SEALS - FORD - 55-56

PART #	DESCRIPTION	YEAR	PRICE
Mfg. USA in our Shop			
B5A-7003110-G	Windshield Rubber Seal with Groove For Chrome #59A Mainline 2-Door Ranch Wagon #64A Fairlane Crown Victoria w/ solid top #64B Fairlane Crown Victoria w/Transparent Top #64C Fairlane Victoria #64D Customline Victoria #70A Mainline 2-Door Sedan #70D Mainline Business 2-Door Sedan #73A Mainline 4-Dr Sedan #78A Sedan Delivery	55 55-56 55-56 56 56 55 55 55 55	59.95 ea.
B5A-7003110-H	Windshield Rubber Seal With Groove for Chrome #57A Fairlane 4-Door Victoria #59B Customline Ranch Wagon #59C Fairlane Ranch Wagon #60B Fairlane Victoria #70B Customline 2-Door Sedan #70C Fairlane Club Sedan #73B Customline 4-Door Sedan #73C Fairlane Town Sedan #59A Mainline 2-Door Ranch Wagon #70A Mainline 2-Door Sedan #70D Mainline Business 2-Door Sedan #73A Mainline 4-Door Sedan #78A Sedan Deliver (from 6/1/56) #79 All 4-Door Station Wagons	56 55-56 56 55 55-56 55-56 55-56 55-56 56 56 56 56 56 56 55-56	59.95 ea.
B5A-7003110-J	Windshield Rubber Seal Without Groove for Chrome #59A Mainline 2-Door Ranch Wagon #70A Mainline 2-Door Sedan #70D Mainline 2-Door Business Sedan #73A Mainline 4-Door Sedan #78A Sedan Delivery	55-56 55-56 55-56 55-56 55-56	59.95 ea.
B5A-7603110-B	Windshield Rubber Seal With Groove for Chrome #76B Fairlane Convertible	55-56	59.95 ea.

#63A...#76 HUH??

What do these numbers mean in our catalog?



Various parts in this catalog are identified with Body Type Codes. A complete listing of these codes and the body types which they represent are shown on page 149.

For instance, a 54A would equal a Galaxie Town Sedan.

This code can be found on the Body Plate located on the door pillar of your car.

This way you can be sure the parts you're ordering fits your car!



WINDSHIELD SEALS - FORD - 57-59

PART #	DESCRIPTION	YEAR	PRICE
Mfg. USA in our Shop			
B7A-7003110-C	#59 Ranch Wagon - 2 dr. #66 Ranchero #70 Custom - 2 dr. Sedan #73 Custom - 4 dr. Sedan #78 Sedan Delivery #79 - 4 dr. Station Wagon	57-58	59.95 ea.
B7A-6403110-A	#51A Retractable #57A Fairlane 500 Town Victoria #58B Fairlane 500 Town Sedan #63A Fairlane 500 Club Victoria #64B Fairlane 500 Club Sedan #76 Convertible	57-58	59.95 ea.
B7A-6403110-B	#57B Fairlane Town Victoria #58A Fairlane Town Sedan #63B Fairlane Club Victoria #64A Fairlane Club Sedan	57-58	59.95 ea.
B9A-6403110-B	All except #51A & #76	59	74.95 ea.
B9A-7603110-B	#51A Retractable #76 Convertible	59	74.95 ea.

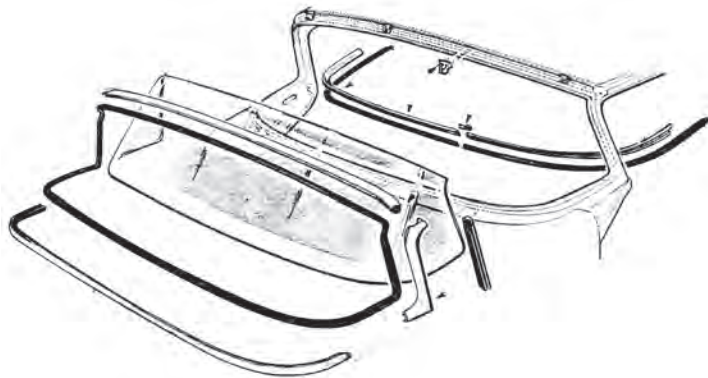

WINDSHIELD SEALS - MERCURY - 52-59

PART #	DESCRIPTION	YEAR	PRICE
Mfg. USA in our Shop			
BA-7603110-D	<u>Windshield Rubber Seal with Groove for Chrome</u> #60B 6-Passenger Monterey..... #60E 6-Passenger Sport #60F 6-Passenger Sun Valley #76B 6-Passenger Monterey Conv.	52-54 52-54 53-54 52-54	69.95 ea.
BA-7003110-F	<u>Windshield Rubber Seal with Groove for Chrome</u> #70B 2-Door Sedan..... #73B 4-Door Sedan..... #73C Monterey 4-Door Sedan..... #79B 8-Passenger Wagon..... #79D 6-Passenger.....	53-54 53-54 53-54 53-54 53-54	69.95 ea.
B5A-7003110-G	<u>Windshield Rubber Seal with Groove For Chrome</u> #58A Montclair 4-Dr. Sedan..... #64A 6-Passenger Montclair Coupe #64B 6-Passenger Montclair Sun Valley Coupe..... All body styles ex. Conv.....	55 55 55 56	59.95 ea.
B5A-7003110-H	<u>Windshield Rubber Seal with Groove for Chrome</u> #60B 6-pass. Monterey Coupe..... #60E 6-pass. Sport Coupe..... #70B 2-Dr. Sedan..... #73B 4-Dr. Sedan..... #73C Monterey 4-Dr. Sedan..... #79B 8-Passenger Wagon..... #79D 8-Passenger Monterey Wagon	55 55 55 55 55 55 55	59.95 ea.
B5A-7603110-B	<u>Windshield Rubber Seal with Groove for Chrome</u> #76A Custom Conv..... #76B 6-Passenger Monterey Conv.. #76B Montclair Convertible.....	56 55 56	59.95 ea.
BAE-6403110-B	<u>Windshield Seal</u> All except #65 & #75.....	57-58	79.95 ea.
BAE-6503110-B	<u>Windshield Seal - Montclair</u> #65A 2-Door Turnpike Cruiser..... #75A 4-Door Turnpike Cruiser.....	57-58 57-58	149.95 ea.
BAE-6503110-B	<u>Windshield Seal - Parklane</u> #75B 4-Dr Turnpike Cruiser	58	149.95 ea.

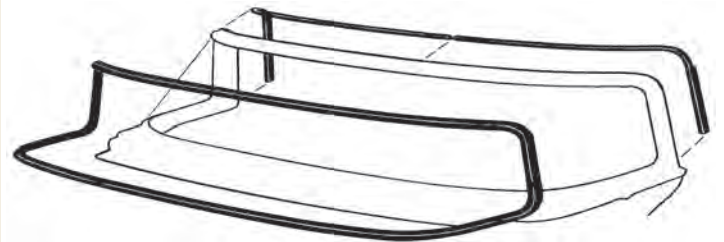



PREMIUM LINE
WEATHER STRIPPING
by Dennis Carpenter



Salt Is The Cure
 and this machine makes it work.



Technically a mixture of potassium nitrate and sodium nitrate is used to cure the rubber that our Premium Line windshield and rear window seals are made of but that's only part of the story. In the mid 1980's Dennis Carpenter envisioned a facility equipped with the machinery that could manufacture his brand of Ford weather stripping that was formulated to his specifications. Then in 1987 Dennis and employee Karl Young, along with other skillful Carpenter employees, embarked on a six month long project to construct a machine that would extrude the rubber necessary to make Ford window and door seals. The finished extrusion machine consisted of a Davis-Standard Model 350SII extruder turning a 3 1/2" diameter screw, 70' of elevated stainless steel curing tanks connected to an additional 30' of water filled stainless steel tanks needed for cooling and rinsing the heated rubber. To resist corrosion from the potassium/sodium nitrate mixture all of the plumbing, hardware, and fixtures used in the construction were also made of stainless steel. With the safety of his employees in mind a complete exhaust system was constructed and installed to extract the fumes generated by the curing process.

Finally in November of 1987 as witnessed by Dennis Carpenter, Karl Young, and a few employees the first footage of Ford windshield rubber extrusion began flowing through the dies. To this day the same rubber extrusion machine that Dennis and his employees built over a quarter century ago is still being used at Carpenter Industries and is capable of producing over 15,000 feet of extruded rubber during a ten hour shift.





BACK WINDOW SEALS - FORD

PART #	PIC	DESCRIPTION	YEAR	PRICE
BA-6042084-E		- (3) piece glass #60B Crestline Victoria	52	159.95 ea.
BA-7042084-E		- w/o Groove For Chrome #70A Mainline 2-Door Sedan #72C Mainline Business Coupe #73A Mainline 4-Door Sedan	52-54 52-54 52-54	69.95 ea.
BA-7042084-F		- w/ Groove for Chrome #70B Customline 2-Door Sedan #72B Customline Club Coupe #73B Customline 4-Door Sedan #73C Crestline 4-Door Sedan	52-54 52-54 52-54 53-54	69.95 ea.
BF-6042084-A		#60B Crestline "Victoria" #60F Crestline "Skyliner"	53-54 54	79.95 ea.
B5A-6442084-C		#64 Crown Victoria	55	89.95 ea.
B6A-6442084-H	A	#64A Crown - Solid Top #64B Crown - Transparent Top #64C Fairlane 2-Dr Hardtop #64D Customline 2-Dr Hardtop	56 56 56 56	89.95 ea.
B5A-7042084-D		- w/ Groove for Chrome #60B Fairlane "Victoria" #70B Customline 2-Dr Sedan #70C Fairlane Club Sedan #73B Customline 4-Dr Sedan #73C Fairlane Town Sedan #70A Mainline 2-Door Sedans #73A Mainline 4-Door Sedan	55 55-56 55-56 55-56 55-56 56 56	79.95 ea.
B5A-7042084-E		- w/o Groove For Chrome #70 Mainline 2-Door Sedan #73A Mainline 4-Door Sedan	55-56 55-56	79.95 ea.
B7A-6442084-A	A	#58 Fairlane Town Sedans #63 Fairlane Club Victorias #64 Fairlane Club Sedans	57-58	119.95 ea.
B7A-7042084-A		#70 Custom 2 dr. Sedans #73 Custom 4 dr. Sedans	57-58	119.95 ea.
B7A-5142084-A		#51A Retractable	57-59	79.95 ea.
B7A-6642084-B		#66 Ranchero	57-59	59.95 ea.
B9A-5442084-A		#54A GalaxieTown Sedan #64H Galaxie Club Sedan #65A Galaxie Club Victoria #75A Galaxie Town Victoria	59	79.95 ea.
B9AB-6442084-C		#57A Fairlane 500 Town Victoria #58 Fairlane Town Sedans #63A Fairlane 500 Club Victoria #64 Fairlane Club Sedans	59	99.95 ea.

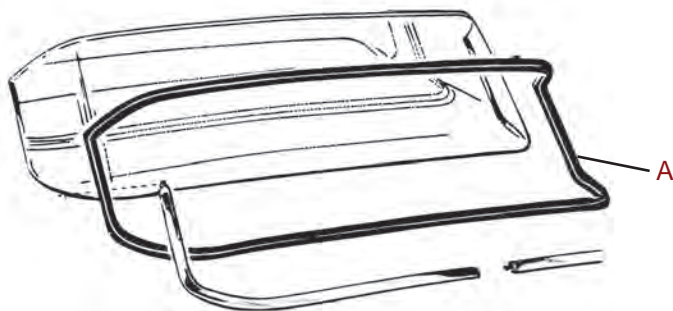

BACK WINDOW SEALS - MERCURY

PART #	PIC	DESCRIPTION	YEAR	PRICE
BA-7042084-F		- w/ Groove for Chrome #70B 2 dr. Sedan #73B 4 dr. Sedan #73C Monterey 4 dr. Sedan	52-54	69.95 ea.
BU-6042084-B		#60B 6-Pass. MontereyCoupe #60E 6-Pass. Sports Coupe #60F 6-Passenger Monterey Sun Valley Coupe	53-54 53-54 53-54	79.95 ea.
B6A-6442084-H	B	#64A Montclair 2-Dr Hardtop	56	89.95 ea.
B5A-7042084-D		- w/ Groove for Chrome #60B 6-Pass. Monterey Coupe #60E 6-Pass. Sports Coupe #70A 2-Door Sedan #73 4-Door Sedan #73C Monterey 4-Door Sedan	55 55 55-56 55-56 55-56	79.95 ea.



#63A...#76 HUH??

What do these numbers mean in our catalog?



Various parts in this catalog are identified with Body Type Codes. A complete listing of these codes and the body types which they represent are shown on page 149.

For instance, a 54A would equal a Galaxie Town Sedan.

This code can be found on the Body Plate located on the door pillar of your car.

This way you can be sure the parts you're ordering fits your car!

WEATHER STRIPPING GLUE - Black

PART #	PRICE
C0AZ-19554-A	11.95 ea.



Comes in 5oz. tube.
Glue is black in color to blend in with your weather stripping for a beautiful and clean look.

DOOR SEALS - 1952-54 - 2-DOOR



PART #	PIC	DESCRIPTION	YEAR	PRICE
*BA-7020530-PR		#59 2 dr. Ranch #70 2 dr. Sedan #72 2 dr. Coupe, & Sedan Del. Will fit front doors on: - #73 4 dr. Sedan - #79 4 dr. Station Wagon	52-54	99.95 pr.
*BA-7620530-PR	A	#76 Convertible #60 Victoria	52-54	99.95 pr.
*BA-7320530-SET		#73 - 4-dr. Sedan	52-54	224.95 kit

DOOR SEALS - 1956



PART #	PIC	DESCRIPTION	YEAR	PRICE
*B6A-7020530-PR		#70 2 dr. Sedan #59 2 dr. Ranch Wagon #78 Sedan Delivery	56	99.95 pr.
*B6A-7320530-SET		#73 4-Door Sedan	56	224.95 kit
*B6A-7620530-PR		#76 Convertible #64 Crown Victoria #64C Victoria	56	99.95 pr.
*B6A-7420530-PR		#73 - 4-dr Sedan for Australian Utilities Vehicles	56	99.95 pr.

A

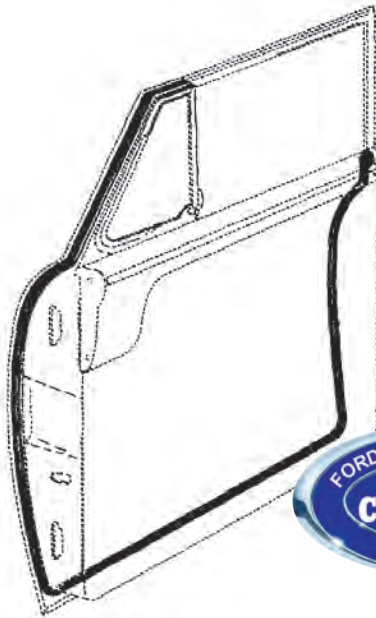

DOOR SEALS - 1955

PART #	PIC	DESCRIPTION	YEAR	PRICE
*B5A-7020530-PR		#70 2 dr. Sedan #59 2 dr. Ranch Wagon #78 Sedan Delivery	55	99.95 pr.
*B5A-7320530-SET		#73 4-dr. Sedan	55	224.95 kit
B5A-6020530-PR		#60B Victoria	55	99.95 pr.
*B5A-7620530-PR		#76 Convertible #64 Crown Victoria	55	99.95 pr.

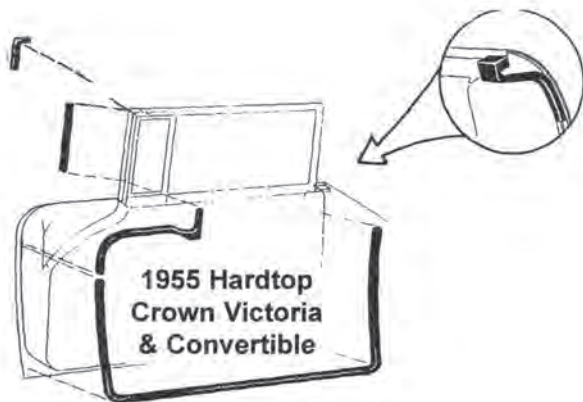
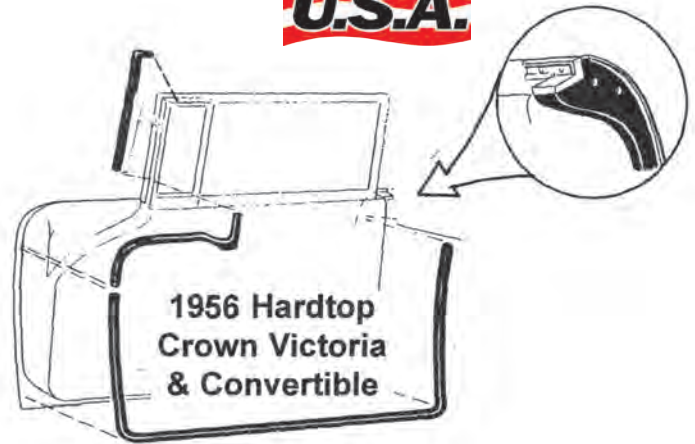
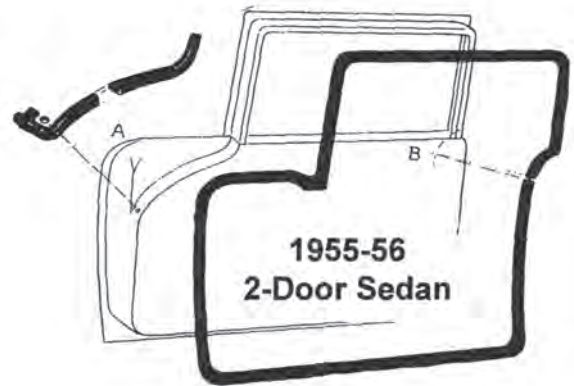

DOOR SEALS - 1957-59



PART #	PIC	DESCRIPTION	YEAR	PRICE
B7A-6420530-PR		#64A Fairlane Club Sedan #64B Fairlane 500 Club Sedan (like a hardtop, but has a post)	57-58	119.95 pr.
B7A-7020530-PR		#59 2 dr. Ranch Wagon #66 Ranchero #70 2 dr. Sedan, Custom #78 Sedan Delivery	57-58	99.95 pr.
B7A-7020530-PR		#70B Custom 2 dr. Sedan	57	99.95 pr.
B7A-7320530-SET		#73 4 dr. sedan	57-58	239.95 set
B7A-7620530-PR		#51A Retractable #57 Fairlane Town Victorias #63 Fairlane Club Victorias #76 Convertible	57-58	99.95 pr.
B9A-7320530-SET		#54 Galaxie Town Sedan #58A Fairlane Town Sedan #58B Fairlane 500 Town Sedan #58E Custom 300 4 dr. Sedan #71 4 dr. Station Wagon	59	239.95 set
B9A-7020530-PR		#59 2 dr. Station Wagon #64 2 dr. Sedan #66C Ranchero	59	99.95 pr.
B9A-7620530-PR		#51 Retractable #76 Convertible #63 2 dr. Hardtop	59	99.95 pr.

DOOR SEALS - 1957-58 - MERCURY



PART #	PIC	DESCRIPTION	YEAR	PRICE
BAE-6320530-PR		Door Seals #56 2 dr. Wagon #63 Phaeton Coupe #65 Turnpike Cruiser #76 Convertible	57-58	149.95 pr.

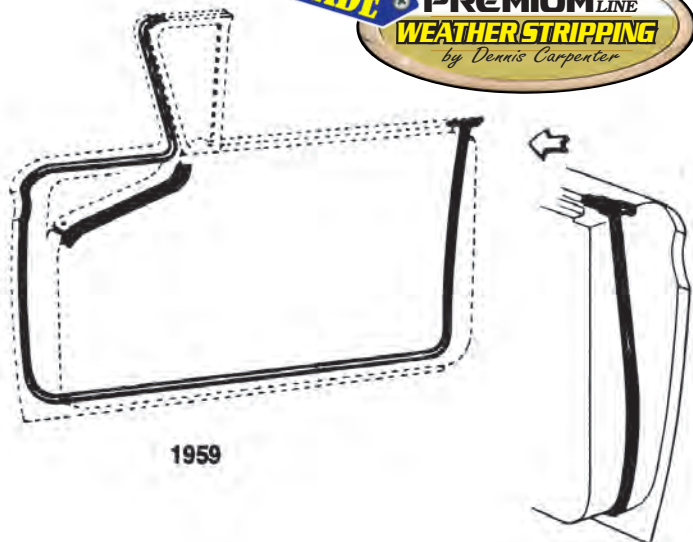

1959

NOTE: All door seals are reproduced exactly as when car was new. Complete with special molded corners & installation instructions. - NO DETAIL OVERLOOKED!

DOOR SEAL PARTS



PART #	PIC	DESCRIPTION	YEAR	PRICE
B5A-6420536-PR		Top Rear of Door Seal - Included in Door Seal Kit	55	19.95 pr.
B6A-7620565-PR		- Included in Door Seal Kit - #63 Hardtop - #64 Crown Victoria - #76 Convertible	56	39.95 pr.

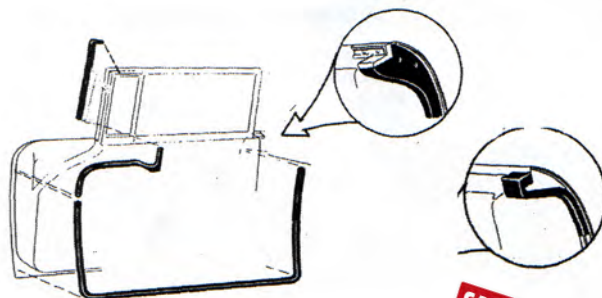

INNER DOG LEG SEALS



PART #	PIC	DESCRIPTION	YEAR	PRICE
B5A-7020570-PR		Inner Dog Leg Weatherstripping for Door - Included w/ Door Seal Kit	55-56	9.95 pr.
B7A-7020580-PR	B	- Not Included w/ Door Seals	57-58	39.95 pr.
B9A-7020580-PR		- Not Included w/ Door Seals	59	39.95 pr.

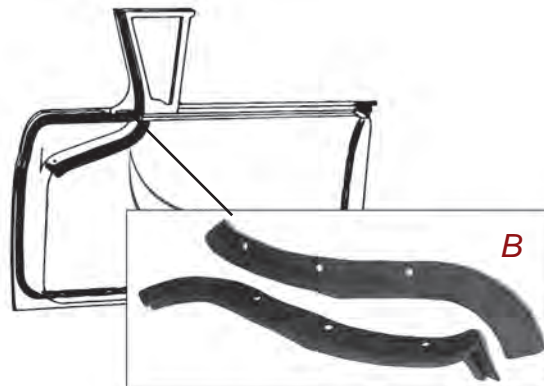

DOOR BUMPERS

PART #	PIC	DESCRIPTION	YEAR	PRICE
BA-13398-B	C	Lower Door Bumper Fits: 2-Door Hardtop, Conv. & Retractable	55-58	4.95 pr.
358939-S	D	- with Threaded End - slips over screw head	55-58	6.95 pr.
372167-L	E	Lower Door Bumper - 5/8" High - Retractable Only - Fits on rear lower door jamb	57-59	4.95 pr.





TRUNK LID PARTS

PART #	PIC	DESCRIPTION	YEAR	PRICE
B9A-16792-S		Trunk Torsion Bar Anti-Rattler	57-59	2.95 ea.



GLASS TOP RUBBER - Mfg. in USA

PART #	PIC	DESCRIPTION	YEAR	PRICE
B4A-6450080-A	A	Glass Top Rubber	54	99.95 ea.
B5A-6450080-B		Glass Top Rubber - Ford	55-56	99.95 ea.
BU-6450080-A		- Mercury	55-56	109.95 ea.

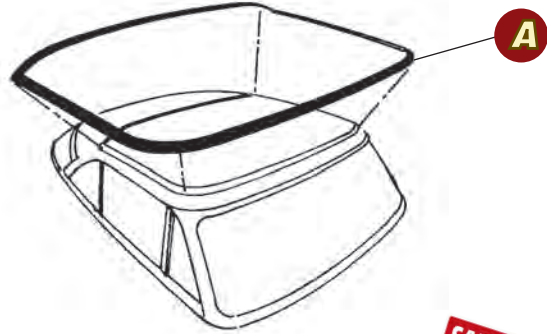

TRUNK LID BUMPER

PART #	PIC	DESCRIPTION	YEAR	PRICE
BD-16754-A		Trunk Lid Bumper - All Except Sedan & Wagon	52-54	11.95 pr.

ROOF RAIL WEATHERSTRIP



PART #	PIC	DESCRIPTION	YEAR	PRICE
BF-6051222-PR		- Ford & Mercury - 2-Door Hardtop	52-54	219.95 pr.
B5A-6451222-PR	B	- Cloth covered like original - Crown Victoria	55	99.95 pr.

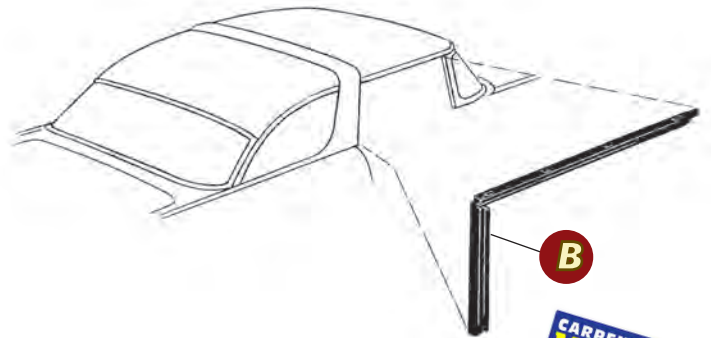

TRUNK LID SEAL



PART #	PIC	DESCRIPTION	YEAR	PRICE
BA-7043720		Trunk Lid Seal - All except Retractable. - See page 145 for Retractable Trunk Seal	52-59	24.95 ea.

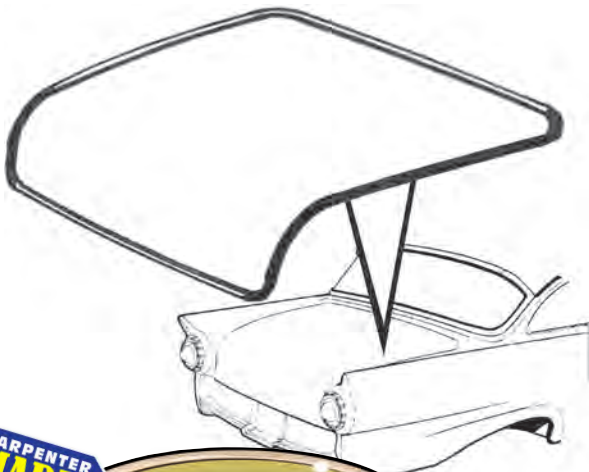

ROOF RAIL SIDE SEALS



PART #	PIC	DESCRIPTION	YEAR	PRICE
B6A-6451676-PR	C	Roof Side Rail Front Corner Seal - Glues on body - Crown & Hardtop	56	19.95 pr.
B6A-6451678-PR	D	Roof Side Rail Center Seal - Fits Hardtop Only	56	19.95 pr.

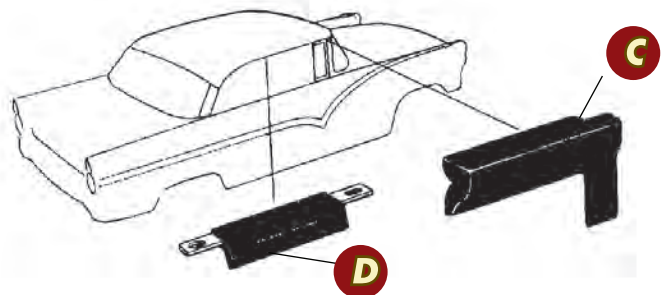

CONVERTIBLE TOP WEATHERSTRIPPING

PART #	PIC	DESCRIPTION	YEAR	PRICE
Convertible Top Kits are all cloth covered and are exact of original! Mounting bolts not included.				
BA-6451562-KIT		- (10) piece	52-54	349.95 kit
B5A-6451562-KIT	E	- (7) pieces	55-56	349.95 kit
B7A-6451562-KIT		- (7) pieces	57-58	349.95 kit
B9A-7651562-KIT		- (7) pieces	59	349.95 kit



HEADER BOW SEALS

PART #	PIC	DESCRIPTION	YEAR	PRICE
BA-7651330-B		<u>Header Bow Seal</u>		
*B5A-7651338-A		- on Top Header	52-54	14.95 ea.
B7A-7651338-A		- on Top Header	55-56	9.95 ea.
*BA-7651338-B		- on Top Header	57-58	9.95 ea.
		- on top of windshield frame	52-54	14.95 ea.
B7A-7603144-S		<u>Header Chrome to top of Windshield Seal</u>	57-58	7.95 ea.

CONVERTIBLE TOP PARTS

PART #	PIC	DESCRIPTION	YEAR	PRICE
B7A-6351630-S		<u>Top Irons to Door Glass Weatherstripping Shim</u> - Rubber - 8" length - Retractable & Convertible	57-59	9.95 ea.
B5A-7629986-A		<u>Folding Top Side Arm Bumper</u> - Convertible	55-58	14.95 pr.
B5A-7654682-PR		<u>Folding Top Compartment Watershield Assembly</u>	55-56	49.95 pr



CONVERTIBLE TOP PARTS

PART #	PIC	DESCRIPTION	YEAR	PRICE
<u>Weatherstripping to Top Iron Bolt</u>				
*353014-S		- (16) pieces per car - Merc.	52-58	1.50 ea.
*353013-L	F	- (6) pieces per car - Merc.	52-58	0.95 ea.
*353014-S		- (22) pieces per car - Ford	52-58	1.50 ea.
353014-SET	G	- (22) piece KIT - Ford	52-58	21.95 kit



353014-SET
Includes 22 bolts
and matching nuts

RETRACTABLE FLAPPER SEALS & BUMPER



PART #	PIC	DESCRIPTION	YEAR	PRICE
EXACTLY AS ORIGINAL				
B7A-5151376-A	A	Front of Flapper Seal - 1st seal on front edge of flapper	57-58	19.95 ea.
B7A-5151306-A	B	Front of Flapper Seal - 2nd seal on front edge of flapper	57-58	74.95 ea.
B9A-5151306-A	B	- 2nd seal on front edge of flapper	59	74.95 ea.
B7A-5151308-PR	C	Side of Flapper Seal - Cloth covered like original - mounts on side of flapper	57-58	59.95 pr.
B9A-5151308-PR	C	- mounts on side of flapper	59	59.95 pr.
B7A-5151322-A	D	Rear of Flapper Seal - between top & flapper	57-58	9.95 ea.
B9A-5151322-A	E	- has special molding ends.....	59	24.95 ea.
B9A-5151732-A	F	- has special molded ends	59	19.95 ea.
B7A-5153942-A	G	Flapper to Roof Bumper	57-58	7.95 pr.

RETRACTABLE RUBBER PARTS ON ROOF



PART #	PIC	DESCRIPTION	YEAR	PRICE
EXACTLY AS ORIGINAL				
B7A-5151348-PR	H	Rear of Roof Side Seal - mounts on roof	57-59	37.50 pr.
B7A-16769	I	Roof Assy. to Quarter Panel Bumper - Set of (4)	57-59	14.95 set

RETRACTABLE ROOF RAILS



PART #	PIC	DESCRIPTION	YEAR	PRICE
EXACTLY AS ORIGINAL				
B7A-5151222-PR	J	Roof Side Rail Weatherstripping - cloth covered like original	57-58	174.95 pr.
B9A-5151222-PR	J	- cloth covered like original	59	174.95 pr.
B7A-6351630-S		Roof Rails to Top Shim - Rubber - 8 ft.	57-59	9.95 pr.

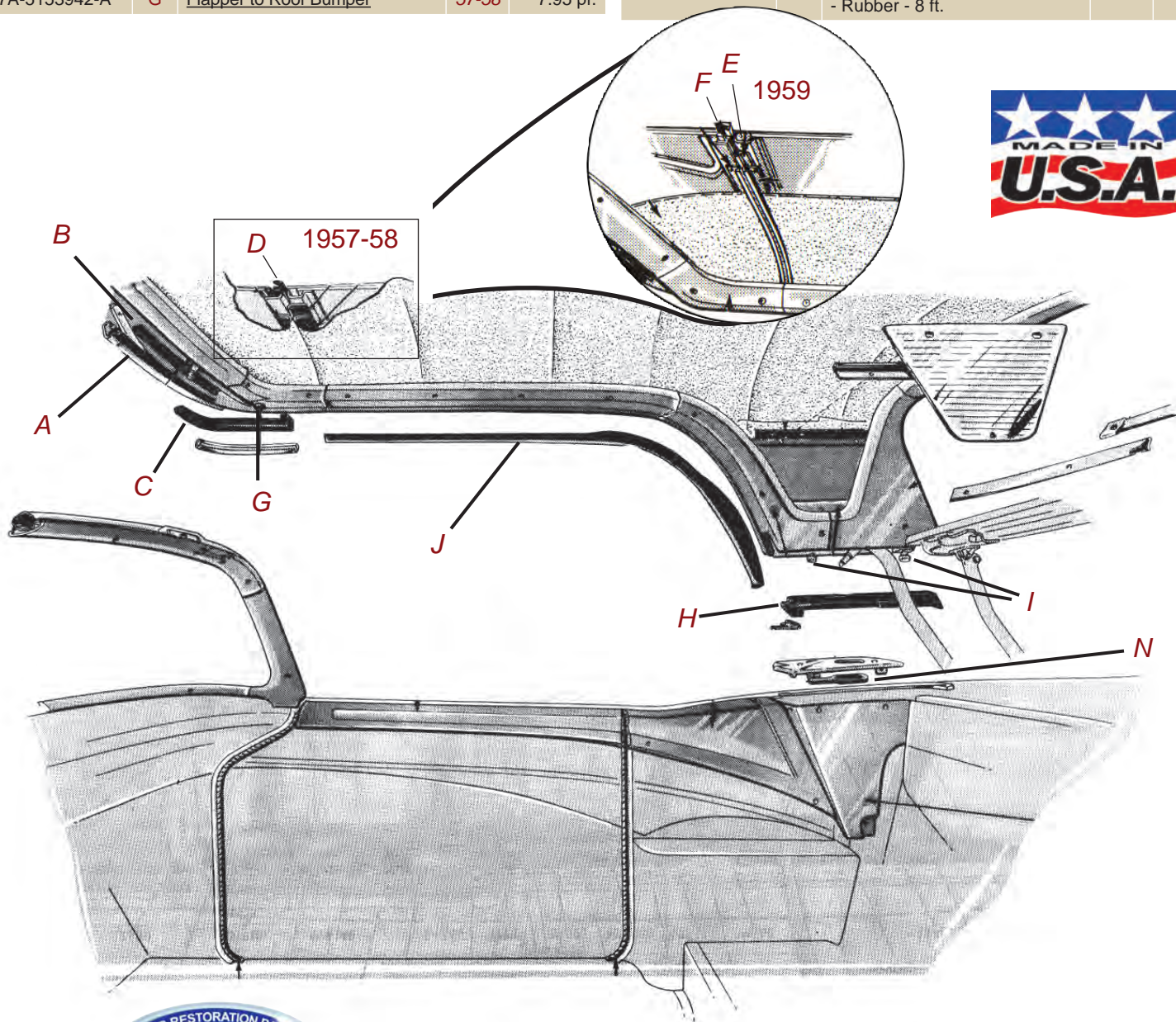

RETRACTABLE RUBBER PARTS ON BODY



PART #	PIC	DESCRIPTION	YEAR	PRICE
B7A-5128151-S	K	Flapper to Rear Well Pad - mounts to top of wheel well	57-59	14.95 pr.
B7A-5128158-PR	L	Rear of Roof Side Seal - mounts on top of quarter	57-59	29.95 pr.
B7A-5140220-S	M	Package Tray Pad - Sponge - mounts between trunk lid & package tray when top is down.	57-58	2.95 pr.
B7A-5153895-A	N	Rear Roof Lock Plate Pad	57-59	4.50 pr.

RETRACTABLE TRUNK LID SEALS



PART #	PIC	DESCRIPTION	YEAR	PRICE
EXACTLY AS ORIGINAL				
BA-7043720	O	Trunk Lid Seal for Side & Back - cut to length	57-59	24.95 ea.
B7A-5143720-A	P	Trunk Lid Seal for Front - w/ Special Molded Corners	57-59	34.95 ea.

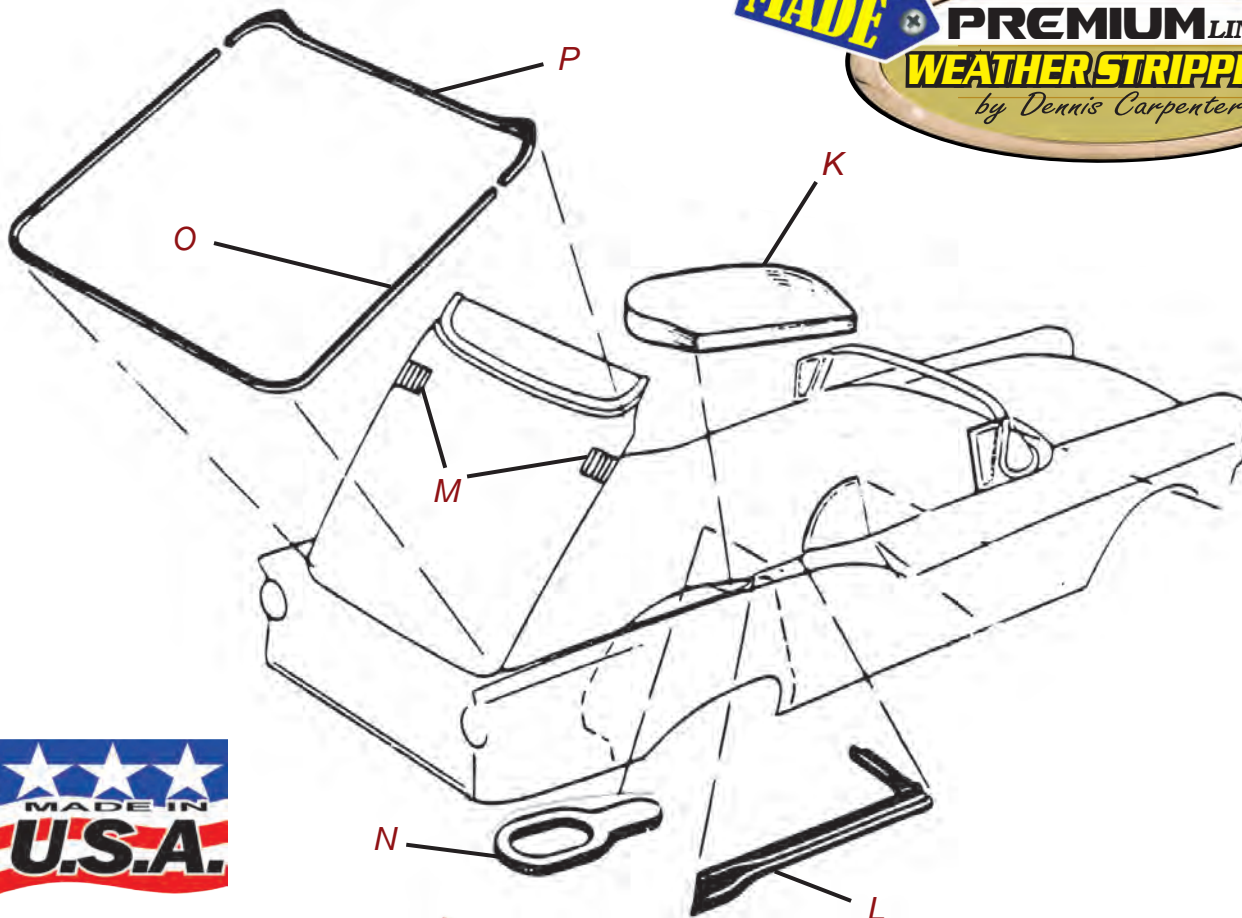

WIRING FOR RETRACTABLE ONLY



PART #	PIC	DESCRIPTION	YEAR	PRICE
B7A-13701-B		License Light Wire	57-58	47.95 ea.
B7A-14276-A		Luggage Compartment Wire	57	224.95 ea.
B7A-14298-A		Power Tray Wire	57-59	539.95 ea.
B7A-14405-E		Rear Lamp Wiring from Junction Box	57	229.95 ea.
FEG-14682-A		Top Circuit Breaker to Starter Solenoid Wire	57-58	29.95 ea.
B7A-14728-A		Top Cycle Actuation Warning Lamp Wire	57-58	34.95 ea.
B7A-14729-B		Top Power Relay Feed Wire	57-58	39.95 ea.

WIRING HARNESS FOR RETRACTABLE ONLY



PART #	PIC	DESCRIPTION	YEAR	PRICE
B7A-15A662-A		Top Motor Lock Wire	57-59	424.95 ea.
B7A-15771-A		Top Control Roof Lock Motor Wire	57	239.95 ea.
B7A-15777-A		Top Control Actuation Switch Wire	57	214.95 ea.
B9A-14276-A		Luggage Compartment Wire	59	199.95 ea.
B9AF-15A569-A		Power Tray Wire	59	549.95 ea.
B9A-15A661-A		Power Top Control Cycle Switch Wire	59	299.95 ea.
B9AF-15A662-A		Top Motor Lock Wire	59	389.95 ea.
FET-15771-B		Top Control Lock Motor Wire	59	219.95 ea.



VENT WINDOW SEALS - No Rivets

PART #	PIC	DESCRIPTION	YEAR	PRICE
*BA-7021448-PR	A	- All Closed Cars & Wagons	52-54	99.95 pr.
*BA-7621448-PR	A	- Convertible & Victoria	52-54	109.95 pr.
B5A-6021448-PR		- #60 Victoria - #60 Mercury Monterey & Sport Coupe	55 55	149.95 pr.
*B5A-7621448-PR	B	- Crown Victoria & Conv. - 2-Door Hardtop Only	55-56 56	99.95 pr.
*B5A-7021448-PR	B	- Ranch, Wagon, 2/4-Door Sedan & Sedan Delivery	55-56	99.95 pr.
B7A-5721448-PR		#51A Retractable #76 Convertible #63 2 dr. Hardtop #57 4 dr. Hardtop	57-58	99.95 pr.
B7A-7021448-PR		#59 2 dr. Wagon #66 Ranchero #70 2 dr. Sedan #73 4 dr. Sedan #78 Sedan Delivery #79 4 dr. Wagon	57-58	99.95 pr.
B9A-6421448-PR		- All Body Styles	59	99.95 pr.



BACK EDGE OF VENT WINDOW SEAL

PART #	PIC	DESCRIPTION	YEAR	PRICE
Like Original With Metal Molded In - Complete With Installation Rivets				
*BA-7021450-PR	C	- 2 & 4 Door Sedans & Wagons	52-54	16.50 pr.
*BA-7621450-PR	C	- Convertible & Hardtop	52-54	16.50 pr.
*B5A-7021450-PR	D	- 2 & 4 Door Sedans	55-56	16.50 pr.
B5A-6021450-PR		- #60 Victoria - #60 Mercury Monterey & Sport Coupe	55 55	24.95 pr.
*B5A-7621450-PR	D	- Crown Victoria, Convertible - 2-Door Hardtop	55-56 56	16.50 pr.
B7A-7021450-PR		#59 2 dr. Station Wagon #66 Ranchero #70 2 dr. Sedan #73 4 dr. Sedan #78 Sedan Delivery #79 4 dr. Station Wagon	57-58	17.50 pr.
B7A-6421450-PR		#58 4 dr. Hardtop with Post #64 2 dr. Hardtop with Post	57-58	19.95 pr.
B7A-7621450-PR		#51 Retractable #76 Convertible #63 2 dr. Hardtop #57 4 dr. Hardtop	57-58	17.50 pr.
B9A-7621450-PR		- All Body Styles	59	17.50 pr.

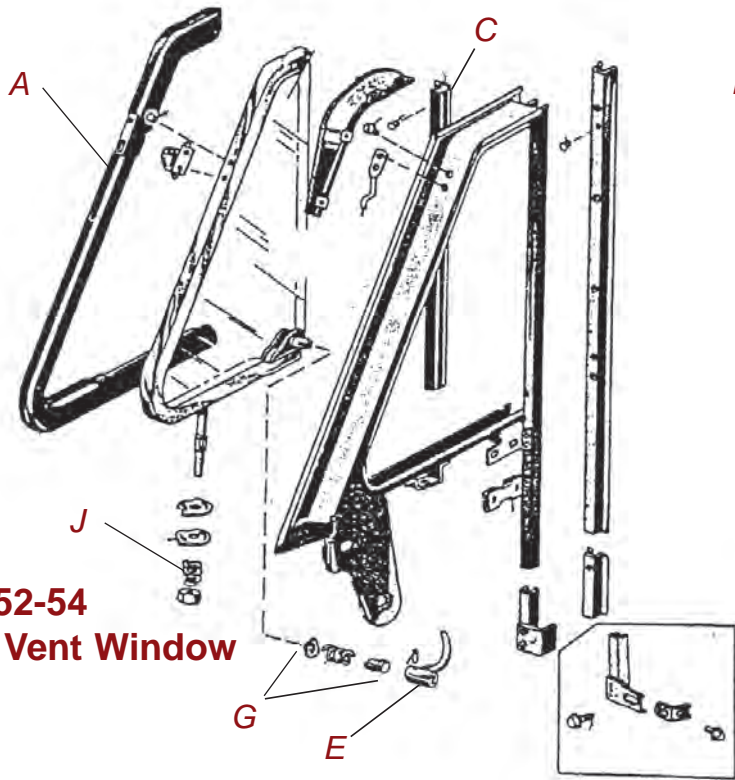

**52-54
Vent Window**

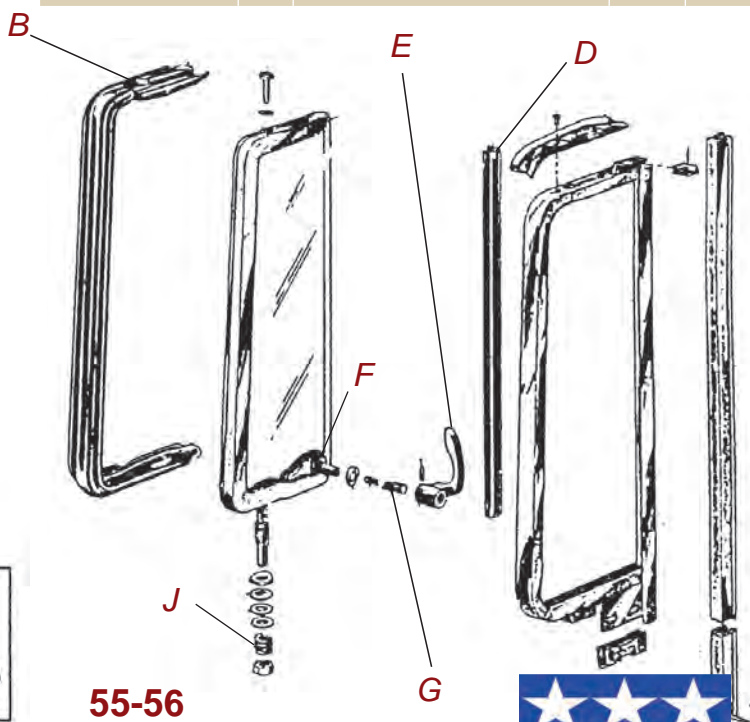

**55-56
Vent Window**

#63A...#76 HUH??

What do these numbers mean in our catalog?

Various parts in this catalog are identified with Body Type Codes. A complete listing of these codes and the body types which they represent are shown on page 149.

For instance, a 54A would equal a Galaxie Town Sedan.

This code can be found on the Body Plate located on the door pillar of your car.



VENT WINDOW HANDLE & BRACKET

Name	Vent Window Handle w/ Button
Part #	A9AZ-7022916-A - RH A9AZ-7022917-A - LH
Note	RH & LH handles are sold individually.
Fits	Does not fit Victoria & Convertible 1952-54
Year	1952-56
Price	24.95 ea.



Name	Vent Window Bracket & Handle Shaft Assembly
Part #	8A-7022938-B - RH 8A-7022939-B - LH
Note	RH & LH assemblies are sold individually.
Year	1949-56
Price	14.95 ea.



Name	Vent Window Handle Button Kit
Part #	8A-7022920-S
Note	For 1 Handle Triple Chrome Plated
Year	1949-56
Price	4.95 kit



UPPER DOOR GLASS BUMPER

PART #	PIC	DESCRIPTION	YEAR	PRICE
B5A-6021774-PR	H	Convertible	55-56	14.95 pr.
B5A-6021774-PR	H	Crown Victoria, 2 Dr Hardtop	55	14.95 pr.
B6A-6021774-PR	I	Crown Victoria, 2/4 Dr Hardtop	56	14.95 pr.
B7A-7621774-PR		#51A Retractable	57-59	14.95 pr.
B7A-7621774-PR		#57 Town Victoria	57-59	14.95 pr.
B7A-7621774-PR		#76 Convertible	57-59	14.95 pr.
B7A-7621774-PR		#63 Hardtop	57-59	14.95 pr.
B7A-7621774-PR		#65A Galaxie Club Victoria	57-59	14.95 pr.
B7A-7621774-PR		#75A Galaxie Town Victoria	57-59	14.95 pr.

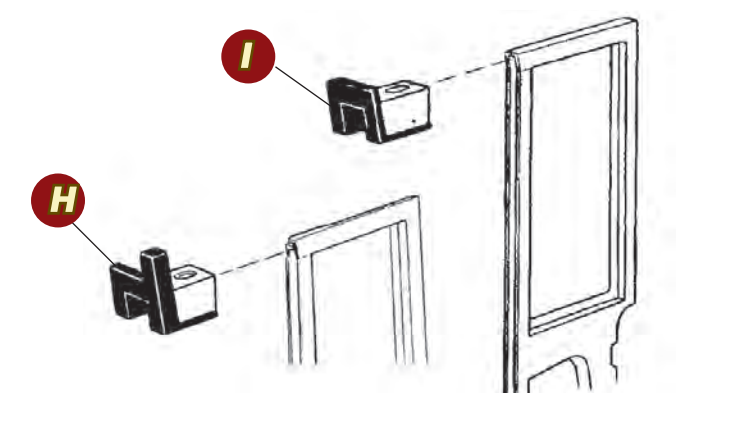

50,000 PART NUMBERS IN STOCK!

SHOP ONLINE

www.dennis-carpenter.com

VENT WINDOW TOP CORNER SEAL

PART #	PIC	DESCRIPTION	YEAR	PRICE
B5A-7621382-PR		- Convertibles Only - Included in Door Seal Kit	55	9.95 pr.



VENT WINDOW ADJUSTMENT HOLE PLUG

Part #	352285-S
Type	1-1/2" plug
Fits	- #63 2-dr Hardtop - #76 Convertibles - 4-dr Hardtops
Year	1953-56
Price	2.95 ea.



VENT WINDOW PIVOT SPRING

Part #	B5A-7022926-A
Year	Ford - 1953-56 Mercury - 1955-56
Price	4.95 ea.



WINDOW CRANK HANDLES

Handles are Chrome with Black or White Knob.
Window Crank Handles include installation clip.

PART #	PIC	DESCRIPTION	YEAR	PRICE
FRONT DOOR				
B5A-7023342-A	A	Black Knob	51-56	24.95 ea.
B7A-7023342-A	B	Black Knob	57	29.95 ea.
B8A-7023342-A	C	White Knob	58-59	29.95 ea.
REAR DOOR				
B5A-7023342-A	D	Black Knob	51-56	24.95 ea.
B7A-7023342-A		Black Knob	57	29.95 ea.
B8A-7023342-A		White Knob #57 4 dr. Hardtop	58	29.95 ea.
B8A-7023342-A		White Knob #58 4 dr. Town Sedan	58	29.95 ea.
B8A-7023342-A		White Knob #73 4 dr. Sedan	58	29.95 ea.
B8A-7023342-A		White Knob #79 4 dr. Wagon	58	29.95 ea.
B8A-7023342-A		White Knob #57A Town Victoria	59	29.95 ea.
B8A-7023342-A		White Knob #58 Town Sedan	59	29.95 ea.
B8A-7023342-A		White Knob #71 4 dr. Wagon	59	29.95 ea.
B8A-6323342-A		White Knob #54A Galaxie Town Sedan	59	34.95 ea.
B8A-6323342-A		White Knob #75A Galaxie Town Victoria	59	34.95 ea.

QUARTER WINDOW				
1A-7630322	E	Black Knob	Hardtop & Convertible	51-56 29.95 ea.
B7A-7023342-B	F	Black Knob	Hardtop & Convertible	57 34.95 ea.
B8A-6323342-A		White Knob #51A Retractable		58-59 34.95 ea.
B8A-6323342-A		White Knob #76B Convertible		58-59 34.95 ea.
B8A-7023342-A		White Knob #63B 2 dr. Hardtop		58 29.95 ea.
B8A-7023342-A		White Knob #64 Club Sedan		58 29.95 ea.
B8A-7023342-A		White Knob #70 2 dr. Sedan		58 29.95 ea.
B8A-7023342-A		White Knob #59 Ranch Wagon		59 29.95 ea.
B8A-7023342-A		White Knob #63A Club Victoria		59 29.95 ea.
B8A-7023342-A		White Knob #64 Club Sedan		59 29.95 ea.
B8A-7023342-A		White Knob #65 Club Victoria		59 29.95 ea.

POWER WINDOW SWITCH AND SWITCH BEZEL

Name	Power Window Switch Bezel
Part #	B5S-14528-A
Type	Chrome
Year	1955-59
Price	29.95 ea.
Name	Power Window Switch
Part #	B7A-14529-B
Type	- Single type
Note	Front or Rear 3 male terminals
Year	1957
Price	39.95 ea.



DOOR HANDLE TOOL
Used to remove or install Door Handle or Window Crank Handle Clip

Part #	TOOL-15
Year	1952-59
Price	6.95 ea.



DOOR & QUARTER WINDOW CRANK HANDLE KNOBS

Manufactured in U.S.A.

PART #	PIC	DESCRIPTION	YEAR	PRICE
1A-7023352	G	Black	51-56	5.95 ea.
B7A-7023352-A	H	Black	57	5.95 ea.
B8A-7023352-A	I	White	58-59	5.95 ea.



DOOR & WINDOW CRANK HANDLE PARTS

PART #	PIC	DESCRIPTION	YEAR	PRICE
357550-S	J	Handle Installation Clip - NOS	51-59	0.60 ea.
*B-7022624-A	K	Handle Spring	All	0.95 ea.
1A-7023370	L	Handle Upholstery Plate	51-52	5.00 ea.



ESCUTCHEON PLATES

For Door Handle, Quarter Window Handle, & Window Crank

Part #	BAAA-8122618
Type	Rubber & Stainless Trim
Note	Need (2) per car
Fits	For Quarter Window Handle #64 Crown Victoria #76 Convertible #63 2-Door Hardtop
Year	1952-59
Price	7.95 ea.



Part #	*B7A-7023370-B
Type	Plastic
Fits	For Window Crank & Door Handle
Year	1952-62
Price	2.95 ea.



FRONT DOOR ARM REST

PART #	PIC	SIDE	COLOR	YEAR	PRICE
B9A-6424140-BL	M	RH	Black	59	24.95 ea.
B9A-6424141-BL		LH	Black	59	24.95 ea.
B9A-6424140-RD	N	RH	Red	59	29.95 ea.
B9A-6424141-RD		LH	Red	59	29.95 ea.



DOOR PANEL CLIPS

Hold panel to door.

PART #	PIC	DESCRIPTION	YEAR	PRICE
B-20015	O	- Set of (50)	52-59	14.95 set
B8A-7020015	P	- Set of (50) - slightly longer	57-67	9.50 set



ARM REST CLIP

Mounts in door for the arm rest screw to attach to. Works on front door, rear door, and quarter arm rests.

PART #	YEAR	PRICE
BA-7024146-A	53-59	2.95 pr.



DOOR OPENING CLIP

Part #	B7A-7002614-A
Type	Door Opening Windlace Clip
Note	Check car & order accordingly
Year	1957-66
Price	2.95 ea.



OUTSIDE DOOR HANDLE

Triple Chrome Plated - No Pads or Buttons
Mounting Hardware is Included.

Outside Door Handles fit ALL except 4 Door Rear Doors



1952-56		
Part #	Side	Price
BA-7022400-C	RH	59.95 ea.
BA-7022401-C	LH	59.95 ea.
BA-7022400-PR	PAIR (RH & LH)	109.95 pr.



1957-58		
Part #	Side	Price
B7A-7022400	RH	62.50 ea.
B7A-7022401	LH	62.50 ea.
B7A-7022400-PR	PAIR (RH & LH)	114.95 pr.



1959		
Part #	Side	Price
B9A-6422404-A	RH	62.50 ea.
B9A-6422405-A	LH	62.50 ea.
B9A-6422404-PR	PAIR (RH & LH)	114.95 pr.



INSIDE DOOR HANDLE

Includes Clips

Part #	B5A-7022600-A
Fits	All
Year	1951-56
Price	19.95 ea.



Part #	C0AZ-6422600-A
Note	Replacment for Hardtop & Convertible
Fits	All
Year	1957
Price	19.95 ea.



Part #	C0AZ-6422600-A
Fits	All
Year	1958-59
Price	19.95 ea.



OUTSIDE DOOR HANDLE PUSH BUTTON

PART #	PIC	SIDE	YEAR	PRICE
BA-7022454-B		RH	52-56	14.95 ea.
BA-7022455-B		LH	52-56	14.95 ea.
B7A-7022454-A	A	RH	57-58	13.95 ea.
B7A-7022455-A		LH	57-58	13.95 ea.



OUTSIDE DOOR HANDLE PADS

Each Kit below does (2) handles.

PART #	PIC	DESCRIPTION	YEAR	PRICE
BA-7222428	B	(4) pieces	52-56	5.95 kit
B7A-7222428	C	(4) pieces	57-58	5.95 kit
B9A-8122428	D	(4) pieces	59	5.95 kit



DOOR & IGNITION LOCK CYLINDERS

Part #	BAAA-7022050-S
Type	<u>Door & Ignition Lock Set</u>
Note	Includes: (1) Ignition Cylinder (1) RH Door Lock Cylinder (1) LH Door Lock Cylinder (1) Key
Fits	All ex/ Retractable
Year	1952-58
Price	49.95 set



Part #	B7A-7021984-PR
Type	<u>Door Lock Set</u>
Note	Includes: (1) RH Door Lock Cylinder (1) LH Door Lock Cylinder (1) Key
Fits	All ex/ Retractable
Year	1952-58
Price	39.95 pr.



DOOR LOCK CYLINDER RETAINER

PART #	PIC	DESCRIPTION	YEAR	PRICE
B5A-7022023-A	E		53-56	4.95 ea.
B7A-7022023-A	F		57-58	16.95 ea.
B5A-7021971-A	G		55-56	5.95 ea.



DOOR HINGE PARTS

PART #	PIC	DESCRIPTION	YEAR	PRICE
*B9A-5943030-A	H	<u>Door Hinge Pin</u> - cut to length	52-59	2.95 ea.
20327-S8 20327-SK	I	<u>Door Hinge Bolt</u> - Each..... - Set of 50.....	55-58 55-58	0.75 ea. 21.95 set
*C3AZ-5422841-B	J	<u>Door Hinge Pin Bushing</u> - Bronze - Replacement	57-59	1.50 ea.



DOOR LOCK ROD PARTS

PART #	PIC	DESCRIPTION	YEAR	PRICE
B9AB-6421952-A	K	Door Lock Rod Clip	56-61	1.95 ea.
B7A-7021850-A	L	Door Lock Control Rod Knob	53-59	6.50 ea.
8M-7221999	M	Door Lock Button to Garnish Molding Grommet	52-56	2.95 ea.



BODY BOLTS

Bolts may fit various locations on body in addition to ones listed below. Check car and order as needed.

DESCRIPTION	Body Bolt
SIZE	5/16" x 24 x 5/8"
LOCATIONS	HOOD, DECK LID
20327-S8	0.75 (each)
20327-SK	21.95 (set of 50)
DESCRIPTION	Body Bolt
SIZE	5/16" x 24 x 1"
LOCATION	FENDER
353483-S	0.50 (each)
353483-SET	19.95 (set of 50)

COAT HANGER w/ Screws

Part #	B2A-7029025-A
Note	Imported
Fits	All Closed Cars
Year	1953-67
Price	9.95 pr.



TAILGATE & IGNITION LOCK CYLINDER SET

Part #	B9A-5943505-SET
Note	Has Edsel Style Keys
Fits	Wagon
Year	1959
Price	74.95 set



Limited Supply



Logo on Front



High Quality Hanes

100% Preshrunk Cotton

Carpenter T-Shirts

Car Back

A



Ford Restoration Parts That **PERFORM**

Classic Ford CAR T-Shirt

PART #	PIC	SIZE	PRICE
CARTRB-M	A	Medium	14.95 ea.
CARTRB-L	A	Large	14.95 ea.
CARTRB-XL	A	X-Large	14.95 ea.
CARTRB-XXL	A	XX-Large	14.95 ea.
CARTRB-XXXL	A	XXX-Large	14.95 ea.

Truck Back

B



Ford Restoration Parts That **PERFORM**

Classic Ford TRUCK T-Shirt

PART #	PIC	SIZE	PRICE
TRUCKTRB-M	B	Medium	14.95 ea.
TRUCKTRB-L	B	Large	14.95 ea.
TRUCKTRB-XL	B	X-Large	14.95 ea.
TRUCKTRB-XXL	B	XX-Large	14.95 ea.
TRUCKTRB-XXXL	B	XXX-Large	14.95 ea.

Carpenter Hats

Dennis Carpenter Ford **CAMO BallCap** **FREE SHIPPING!**

B



C



PART #	PIC	TYPE	SIZE	PRICE
DCF-CAMO	C	Camo w/ solid back	Adjustable	18.95 ea.
DCF-CAMO-M	D	Camo w/ Mesh back	Adjustable	18.95 ea.

Dennis Carpenter Ford **Khaki BallCap**

E



Caps are low profile and 100% brushed cotton with a velcroed back for easy adjustment.

PART #	PIC	COLOR	SIZE	PRICE
DCF-2917	E	Khaki	One size fits all	14.95 ea.

* Shipping is not included but Shirts & Caps do qualify for our flat rate shipping

SEAT BELTS

PART #	PIC	DESCRIPTION	SIDE	YEAR	PRICE
SB-9368-T	A	2 Point Lap Belt - Standard Buckle	Tan		24.95 ea.
SB-9366-R	B	2 Point Lap Belt - Standard Buckle	Red		24.95 ea.
SB-9361-G	C	2 Point Lap Belt - Standard Buckle	Grey		24.95 ea.
SB-9349-BK	D	2 Point Lap Belt - Standard Buckle	Black		24.95 ea.

- **Heavy duty OEM style fabric**
- **CAD Design**
- **Easy push button release**
- **Ideal for all types of vehicles including street rods.**



Seat Belt MOUNTING BRACKET

Safety First! Seat belt anchor kits are ideal for reinforcing your mount for all seat belts. Belt anchors reduce the chance of the belt bolt tearing through the floor when the belt is under load. Rounded corners ensure that your belt will not tear from impact or normal use. Ideal for all applications. Hardware included.

Part #	MB-10178-AN
Type	Angled
Price	19.95 pr.



Part #	MB-10177-ST
Type	Straight
Price	19.95 pr.



SEAT ADJUSTMENT KNOB & RETAINER

Name	Seat Knob & Retainer
Part #	C5AZ-6261753-BA
Type	Black
Note	Includes Retainer Clip
Model	F100/350
Year	1965-86
Price	3.95 ea.



Name	Retainer Clip (only)
Part #	C5AZ-6262060-A
Model	F100/350
Year	1965-86
Price	1.50 ea.



\$9.99 *OR* **\$14.99** **FLAT RATE SHIPPING**
See shipping page for details.

STRIKER PLATES

Striker Plate Bolts are sold separately.

*BA-7022008-A	RH
*BA-7022009-A	LH
Type	(2) screw holes
Year	1950-54
Price	14.95 ea.



*B5A-7022008-C	RH
*B5A-7022009-C	LH
Type	(3) screw holes
Year	1955
Price	19.95 ea.



*B6A-7022008-A	RH
*B6A-7022009-A	LH
Type	(3) screw holes
Year	1956
Price	19.95 ea.



C1TB-9122008-A	RH
C1TB-9122009-A	LH
Type	(3) screw holes
Year	1957-58
Price	19.95 ea.



C0AZ-6222008-A	RH
C0AZ-6222009-A	LH
Type	(3) screw holes
Year	1958
Price	19.95 ea.



STRIKER PLATE BOLT

Part #	353382-S
Year	1949-59
Price	0.95 ea.



STRIKER PLATE INSERTS

PART #	PIC	DESCRIPTION	YEAR	PRICE
B7A-7022040-A	B	Insert - RH or LH - 2 hole	57-58	6.95 ea.
C2AZ-6222040-A	C	Insert - RH or LH - 2 hole	59-62	9.95 ea.



STRIKER PLATE COVERS

PART #	PIC	DESCRIPTION	YEAR	PRICE
B7A-7022014-A	D	Cover - RH - 2 hole	57-58	4.95 ea.
B7A-7022015-A		Cover - LH - 2 hole	57-58	4.95 ea.
C3SZ-6322014-A	E	Cover - RH - 2 hole	59-62	5.95 ea.
C3SZ-6322015-A		Cover - LH - 2 hole	59-62	5.95 ea.



STRIKER PLATE SHIMS AND BOLTS

PART #	PIC	DESCRIPTION	YEAR	PRICE
*BA-7022058-A	F	Striker Plate Shim	50-54	3.95 ea.
*B5A-7022058-A	G	Striker Plate Shim	55-56	3.95 ea.
B7A-7022058-A	H	Striker Plate Shim	57-58	4.95 ea.
C0AB-6422058-A	I	Metal Door Lock Striker Shim	59	5.95 ea.

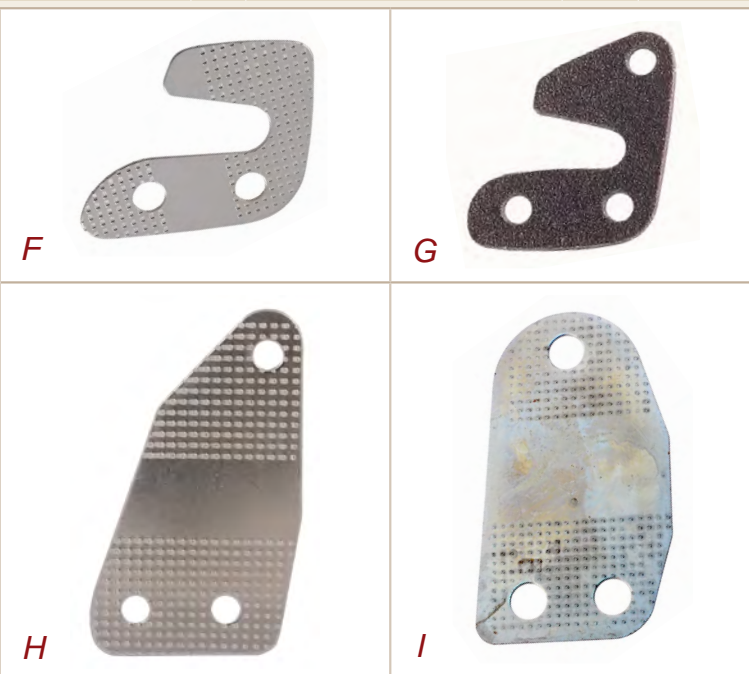

DOOR SCRIPTS - Fasteners Included

PART #	PIC	DESCRIPTION	YEAR	PRICE
B5A-16098-F	J	"Victoria" Script	55-56	69.95 pr.
B5A-16098-G	K	"Sunliner" Script	55-56	74.95 pr.
B5A-6425622-A	L	"Crown Victoria" Script	55-56	89.95 pr.



J

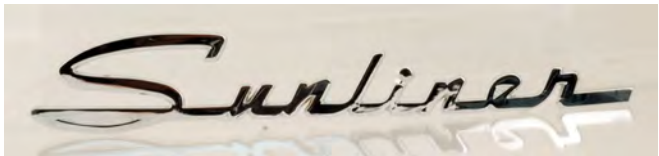

K

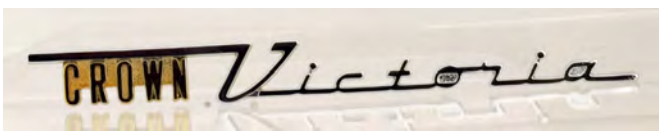

L

DOOR EMBLEM & BEZEL

Fasteners not Included

PART #	PIC	DESCRIPTION	YEAR	PRICE
BM-7325662-B	M	Plastic Emblem		24.50 ea.
B6A-7925666-C	N	Chrome Bezel		19.95 ea.

BODY CODE	BODY STYLE	YEAR
#73C.....	Crestline 4-dr Sedan.....1954
#60B.....	Crestline Victoria.....1955
#64.....	2-dr Crown Victoria.....1955
#70C.....	Fairlane Club Sedan.....1955
#73C.....	Fairlane Town Sedan.....1955
#76.....	Convertible.....1955
#79B.....	Customline "County Sedan" Wagon.....1955
#59C.....	Fairlane Ranch Wagon.....1956



M



N



Carpenter Brand*

- Quality Materials
- Long Lasting
- Exact of original



With over forty-five years of experience Dennis Carpenter is the leading manufacturer and distributor of superior quality Ford weatherstripping and molded rubber parts. Our rubber extrusion department is capable of manufacturing 25,000 feet of specially formulated EPDM rubber to make our quality windshield and rear window seals.

VS.

Competitor Brand*

- Cheap Materials
- Cracks and fades
- Kinda like original



*After 6 months outside in the sun.



FRONT DOOR WINDOW LIFT CHANNELS U.S.A. 1952-54

PART #	PIC	SIDE	DESCRIPTION	PRICE
BA-7021458-A	A	RH	2 Dr. Sedan & Coupe	24.95 ea.
BA-7021459-A		LH	2 Dr. Sedan & Coupe	24.95 ea.
BA-7021458-A	A	RH	2 Dr. Wagon & Sedan Delivery	24.95 ea.
BA-7021459-A		LH	2 Dr. Wagon & Sedan Delivery	24.95 ea.
BA-7321458-A	B	RH	4 Dr. Sedan & 4 Dr. Wagon	24.95 ea.
BA-7321459-A		LH	4 Dr. Sedan & 4 Dr. Wagon	24.95 ea.
BA-7621458-C	C	RH	2 Dr. Hard Top & Convertible	34.95 ea.
BA-7621459-C		LH	2 Dr. Hard Top & Convertible	34.95 ea.



FRONT DOOR WINDOW LIFT CHANNELS U.S.A. 1955-56

PART #	PIC	SIDE	DESCRIPTION	PRICE
B5A-7021458-B	D	RH	2 Dr. Sedan & Coupe	24.95 ea.
B5A-7021459-B		LH	2 Dr. Sedan & Coupe	24.95 ea.
B5A-7021458-B	D	RH	2 Dr. Wagon & Sedan Delivery	24.95 ea.
B5A-7021459-B		LH	2 Dr. Wagon & Sedan Delivery	24.95 ea.
B5A-7321458-B	E	RH	4 Dr. Sedan & 4 Dr. Wagon	24.95 ea.
B5A-7321459-B		LH	4 Dr. Sedan & 4 Dr. Wagon	24.95 ea.
B5A-6021458-B	F	RH	2 Dr. Hard Top & Convertible	34.95 ea.
B5A-6021459-B		LH	2 Dr. Hard Top & Convertible	34.95 ea.

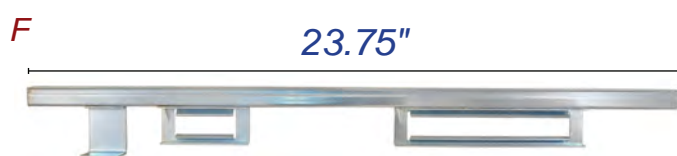
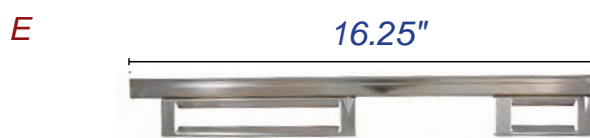

REAR WINDOW LIFT CHANNELS

PART #	PIC	SIDE	DESCRIPTION	PRICE
1952-54				
BA-7326228-A		RH	4 Dr. Sedan & 4 Dr. Wagon	24.95 ea.
BA-7326229-A		LH	4 Dr. Sedan & 4 Dr. Wagon	24.95 ea.



QUARTER WINDOW LIFT CHANNELS

PART #	PIC	SIDE	DESCRIPTION	PRICE
1952-54				
BA-7029900-A	G	RH	2 Dr. Sedan	24.95 ea.
BA-7029901-A		LH	2 Dr. Sedan	24.95 ea.
1955-56				
B5A-7029900-A	H	RH	2 Dr. Sedan	24.95 ea.
B5A-7029901-A		LH	2 Dr. Sedan	24.95 ea.



50,000 PART NUMBERS IN STOCK!



www.dennis-carpenter.com



WINDOW LIFT CHANNEL WEATHERSTRIPPING

PART #	PIC	DESCRIPTION	YEAR	PRICE
	I	Window Lift Channel Seal Rubber piece that goes between glass & window lift channel		
*BA-7621478-C		- 31.5" Long.....	53-56	7.95 ea.
B7A-7621478		- 34.25" Long.....	57-59	7.95 ea.

Made Exactly Like
Original ✓
NOT A GENERIC REPLACEMENT

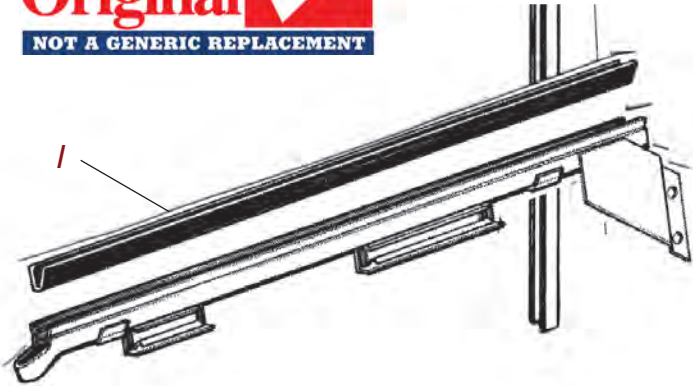

DOOR, QUARTER & VENT WINDOW GLASS SETTING TAPE

PART #	PIC	DESCRIPTION	YEAR	PRICE
8A-7021478	J	- Does 1 glass - 3/64" thick x 4' long x 1 1/2" wide	ALL	6.95 kit
C0AB-7021478		- 1/16" thick x 4' long x 1 1/2" wide	49-59	7.95 ea.

J



WINDOW REGULATOR ROLLER ASSEMBLY

Need (2) per door

PART #	PIC	DESCRIPTION	YEAR	PRICE
BA-7023240-A	K	Nylon	52-58	5.50 ea.
C0AB-6423240-B	L	Plastic	59	1.95 ea.

K



L



POWER WINDOW DRIVE COUPLING

PART #	PIC	DESCRIPTION	YEAR	PRICE
B5A-7023440-A	M	Power Window Drive Coupling		14.95 ea.

BODY CODE	BODY STYLE	YEAR
-----------	------------	------

FRONT DOORS

#60	2 dr. Hardtop	1954
#70	2 dr. Sedan	1954
#73	4 dr. Sedan	1954
#76	Convertible	1954
	Ford	1955-58
	Mercury	1952-56

REAR DOORS

#73	4 dr. Sedan	1954
#57	4 dr. Hardtop	1955-58
#58	Town Sedan	1955-58
#73	4 dr. Sedan	1955-58
#79	4 dr. Wagon	1955-58
	Mercury	1952-56

QUARTERS

#51A	Retractable	1957-59
#70	2 dr. Sedan	1954
#60	Victoria	1955-56
#64	2 dr. Hardtop	1955-59
#70	2 dr. Sedans	1955-58
#76	Convertible	1955-56
	Mercury	1955-56

TAILGATE

Mercury - Station Wagons	1956
--------------------------	------



FRONT DOOR GLASS ANTI-RATTLER

Exact of Original.

Includes (1) outer piece with clips installed & (1) inner piece with installation staples.

PART #	PIC		DESCRIPTION	YEAR	PRICE
BA-6021452-PR	A	RH or LH	Hardtop & Convertible	52-54	19.95 pr.
*B5A-7621452-PR		RH	Crown Victoria, Convertible, 2-Dr Hardtop	55-56	29.95 pr.
*B5A-7621453-PR		LH	Crown Victoria, Convertible, 2-Dr Hardtop	55-56	29.95 pr.
B7A-7621452-PR		RH	Retractable, Convertible, 2-Dr Hardtop	57-58	29.95 pr.
B7A-7621453-PR		LH	Retractable, Convertible, 2-Dr Hardtop	57-58	29.95 pr.

DOOR GLASS RUN - LOCK SIDE

PART #	PIC	DESCRIPTION	YEAR	PRICE	
B7A-7621508-S	B	Rear of Door	Retractable, Convertible, Hardtop	57-58	19.95 ea.
B9A-7621508-S	B	Rear of Door	Retractable, Convertible, Hardtop	59	19.95 ea.

FRONT DOOR DIVISION BAR GLASS RUN

All are pre-drilled

Install on your old brackets

PART #	PIC	DESCRIPTION	YEAR	PRICE
*BA-7022296-U		2-Door & 4-Door Sedan	52-54	29.95 ea.
B5A-7022296-U		2-Door & 4-Door Sedan	55-56	29.95 ea.
B7A-7622296-U	C	Retractable, Convertible, 2 dr. Hardtop	57-58	29.95 ea.

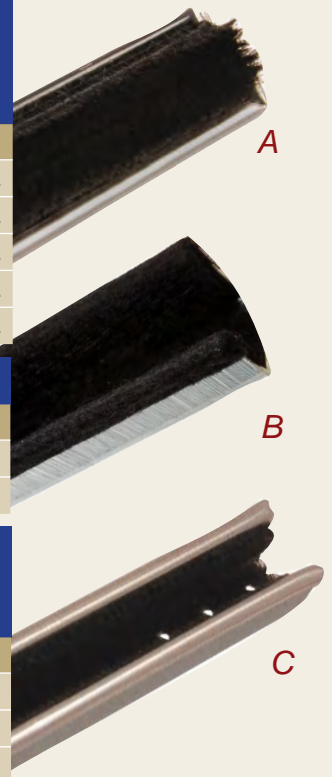

FRONT DOOR GLASS ANTI-RATTLER KIT

Door Glass Anti-Rattlers fit Retractable, Convertible & 2 Dr. Hardtop. Does both doors.



PART #	PIC	YEAR	PRICE
B7A-7621460-S	D	57-58	159.95 kit

INCLUDES

- (1 pr.) #B7A-7621452-PR
- (1 pr.) #B7A-7621453-PR
- (2) #B7A-7621508-S
- (2) #B7A-7622296-U
- (1 pr.) #B7A-7621450

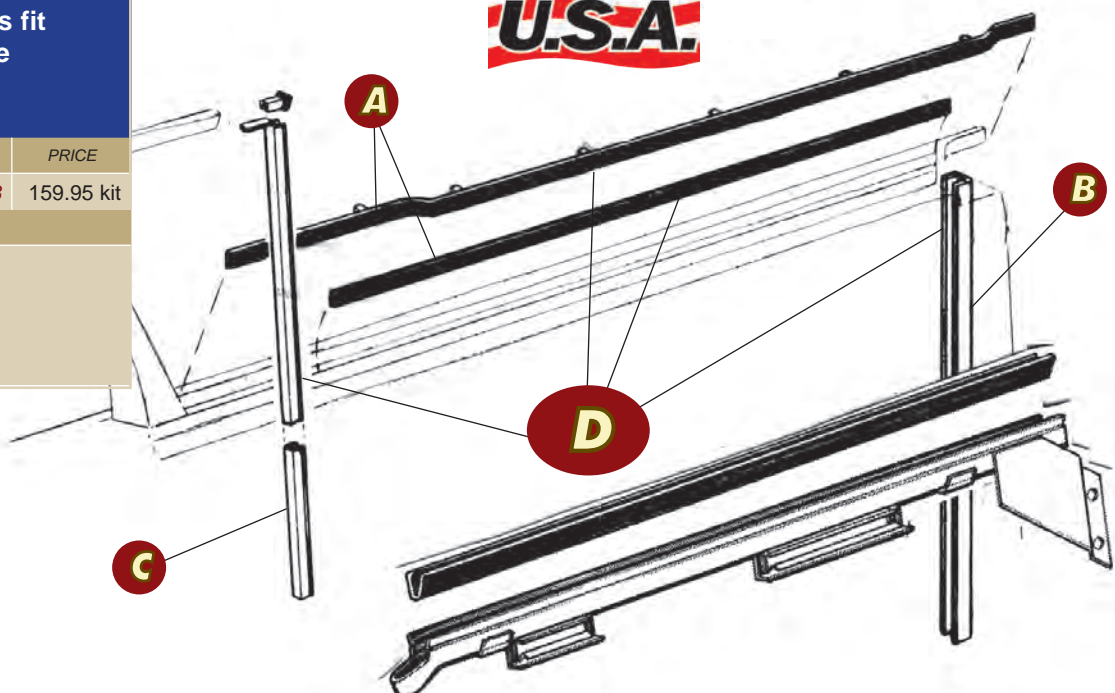

QUARTER WINDOW ANTI-RATTLER KIT

Hardtop & Convertible Kit Comes Pre-Bent with one inner piece, one outer piece, and installation staples.

Note: One pair only does one door - Order accordingly

PART #	PIC	SIDE	FITS	YEAR	PRICE
BA-6029732-PR		RH or LH	2-Dr. Hardtop	52-54	19.95 pr.
B5A-6029732-PR	E	RH	2-Dr. Hardtop	55	24.95 pr.
B5A-6029733-PR		LH	2-Dr. Hardtop	55	24.95 pr.
B6A-6029732-PR		RH	2-Dr. Hardtop	56	29.95 pr.
B6A-6029733-PR		LH	2-Dr. Hardtop	56	29.95 pr.
BA-7629732-PR		RH	Convertible	52-54	19.95 pr.
BA-7629733-PR		LH	Convertible	52-54	19.95 pr.
B5A-7629732-PR		RH	Convertible	55-56	29.95 pr.
B5A-7629733-PR	F	LH	Convertible	55-56	29.95 pr.
B7A-7029732-PR		RH	2 Dr. Sedan	57-58	24.95 pr.
B7A-7029733-PR		LH	2 Dr. Sedan	57-58	24.95 pr.
B5A-6429732-SET	G	RH and LH	Crown Victoria	55-56	59.95 set

NOTE: Our 1955-56 Convertible and Hardtop outer Anti-Rattlers have the special retainers staked in place ready to snap in the holes on top of the quarter. All inner Anti-Rattlers come with special stainless steel staples to install on your garnish molding.

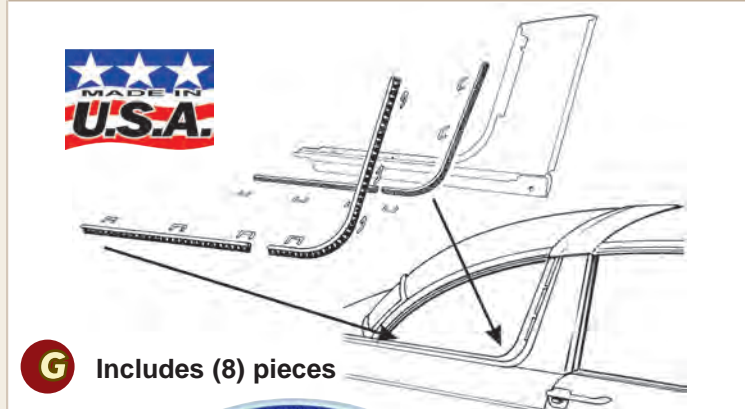
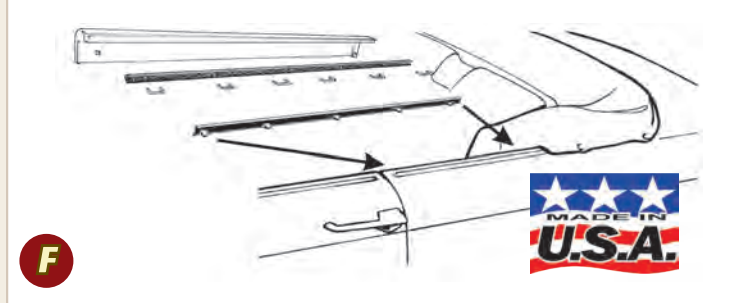
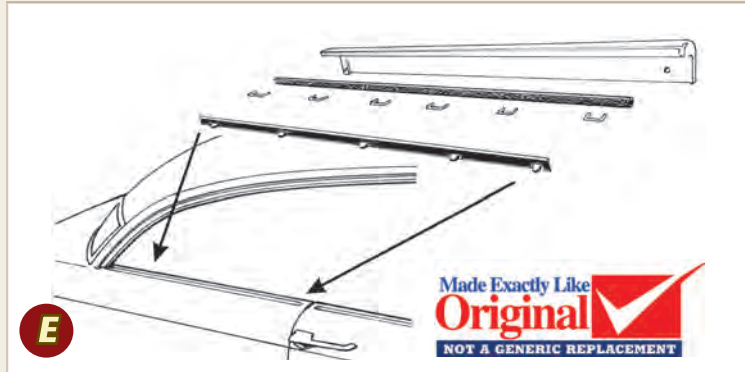

G Includes (8) pieces



DOOR GLASS ANTI-RATTLER - UNIVERSAL

Flexible, Pile Lining, Rubber Covered

PART #	PIC	DESCRIPTION	LENGTH	PRICE
U-7021446-YM3	H	w/ Stainless Steel Bead	96"	24.95 ea.
U-7021446-M123	I	w/ Black Bead	96"	24.95 ea.
U-7021446-M8	J	w/ Fabric Covered Bead	96"	24.95 ea.

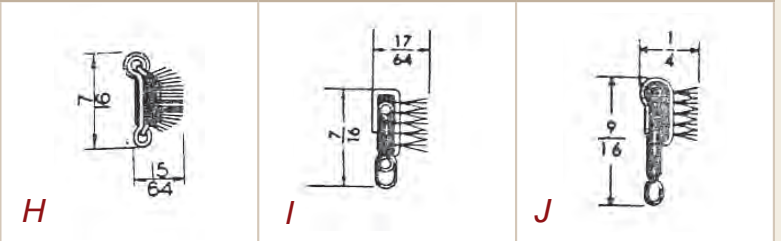

DOOR GLASS RUN - UNIVERSAL

Flexible, Pile Lining, Rubber Covered

PART #	PIC	DESCRIPTION	LENGTH	PRICE
U-7021550-Y526	K	w/ Stainless Steel Bead	60"	29.95 ea.
U-7021550-3C1	L	w/ Fabric Covered Bead	60"	29.95 ea.



QUARTER WINDOW SEAL

For Stationary Windows

PART #	PIC	DESCRIPTION	YEAR	PRICE
BA-7229904-PR		#72C Mainline Business Coupe	52-54	59.95 pr.
B7A-7029904-PR		#70D Business 2-dr	57-58	49.95 pr.
B7A-7929904-A		#79 Station Wagon	57-58	49.95 pr.



50,000 PART NUMBERS IN STOCK!

SHOP ONLINE

www.dennis-carpenter.com

LOWER FRONT OF QUARTER WINDOW PADS

PART #	PIC	DESCRIPTION	YEAR	PRICE
*BA-7629746-PR	A	Convertible & Hardtop	52-54	24.95 pr.
B5A-6420702-PR	B	Crown Victoria	55-56	27.50 pr.
B5A-7629132-PR	C	Convertible	55-56	19.95 pr.
B7A-7629748-PR	D	Retractable ,Conv. & Hardtop	57-58	24.95 pr.
B9A-5129748-PR	E	Retractable ,Conv. & Hardtop	59	24.95 pr.

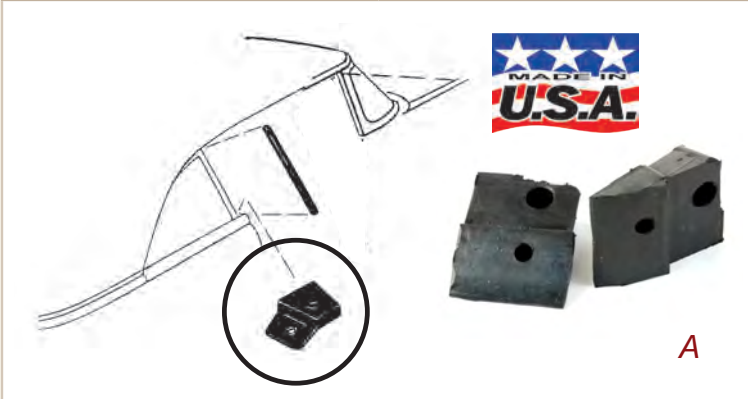

QUARTER LOCK PILLAR UPPER FRONT WEATHER STRIPPING SEAL

Glass closes against seal. Cloth covered like original.

PART #	PIC	DESCRIPTION	YEAR	PRICE
B6A-6428306-PR	F	Crown Victoria	56	49.95 pr.



QUARTER WINDOW LOWER STOP BUMPER

PART #	DESCRIPTION	YEAR	PRICE
B7A-7629986-A	Retractable & Convertible	57-59	11.95 pr.



FRONT EDGE OF QUARTER WINDOW SEAL

PART #	PIC	TYPE	DESCRIPTION	YEAR	PRICE
BA-7630146-S		Cloth Covered	Convertible & 2-Dr Hardtop	52-56	29.95 pr.
BA-7630146-NC		NON-Cloth Covered	Convertible & 2-Dr Hardtop	52-56	11.95 pr.
B7A-5130146-PR	G		Retractable ,Conv. & Hardtop	57-58	29.95 pr.
B9A-6330146-PR			Retractable ,Conv. & Hardtop	59	29.95 pr.
B9A-5725824-PR			4 dr. Hardtop only	57-59	29.95 pr.



\$9.99 or **\$14.99**

FLAT RATE SHIPPING

See shipping page for details.

QUARTER MOLDINGS - No clips included

PART #	PIC	DESCRIPTION	YEAR	PRICE
B6A-7029038-B	H	Stainless - Fits 2-Door Only	56	269.95 pr.
B5A-7029038-C		Stainless - Fits 2-Door Only	55	59.95 ea.



H



QUARTER PANEL MOULDING CLIPS

Part #	B6A-7029144-A
Note	Need (5) per molding
Fits	for B6A-7029038-B
Year	1956
Price	1.95 ea.



REAR QUARTER PANEL MOULDING SPEAR MOLDINGS - Mercury

Chrome Plated - Need (6) per car

PART #	PIC	DESCRIPTION	YEAR	PRICE
BR-7325606-B		Fits Mercury Except Wagon	1954	79.95 ea.



QUARTER PANEL EMBLEM & BEZEL

Fasteners not Included

PART #	PIC	DESCRIPTION	PRICE
BM-7325662-B	I	Plastic Emblem	24.50 ea.
B6A-7925666-C	J	Chrome Bezel	19.95 ea.
BODY CODE		BODY STYLE	YEAR
#76.....		Convertible..... 1954



I



J

SCRIPTS FOR QUARTER PANEL

Scripts include Fasteners

PART #	PIC	DESCRIPTION	YEAR	PRICE
BC-7325622-CPR	K	"Monterey"	52-56	99.95 pr.
B5A-7025622-A		"Club Sedan"	55-56	54.95 pr.
B5A-7325622-A		"Town Sedan"	55-56	54.95 pr.
B6A-5925622-A		"Parklane"	56	74.95 ea.
B7A-6625622-A	L	"Ranchero"	57-58	42.50 ea.
B7A-6425622-PR	M	"Fairlane 500"	57-58	89.95 pr.
B7A-16098-PR	N	"Fairlane"	58	99.95 pr.
B9A-5425622-PR	O	"Galaxie"	59	99.95 pr.



K



L



M



N



O

\$9.99 *or* **\$14.99** **FLAT RATE SHIPPING**
See shipping page for details.



What does it mean? In short, it means Ford parts made EXACTLY like originals

ORIGINAL TOOLING describes the stamping dies, injection molds, roller dies and other tools of mass production that the Ford Motor Company used to manufacture the parts necessary to assemble their cars and trucks. (See ORIGINAL TOOLING below.)



0001

FORD Logo - A most important logo assuring customers of the true origin and authenticity of the classic parts produced from this program. They're also the company responsible for making the tooling in the first place.

0 0 0 1 - These numbers identify Dennis Carpenter Ford Restorations as the first member of a select group to manufacture parts off original tooling, parts which comply with quality standards established by Dennis Carpenter and the Ford Motor Company. What this means is that we've dusted off certain tooling and started using them again, continuing to make quality parts as good or better than the Ford originals.

ORIGINAL TOOLING in Action!

On the right is half of a 1966 Galaxie hub cap forming die mounted in a press. The first stamping operation of making the hub cap is shown below. Each cap proceeds through 9 different stamping operations before completion.



MADE ON
The ORIGINAL Ford Dies

Classic Parts From
Original Tooling

1966 FORD GALAXIE 15" HUB CAPS

Our stamped stainless steel hubcaps are shaped and chrome plated EXACTLY Like the Ford Originals and are available with red or rose colored center caps.
Red center cap #C6AZ-1130-G Rose center cap #C6AZ-1130-A



REAR SEAT BACK EMBLEM & BEZEL

Fasteners not Included

PART #	PIC	DESCRIPTION	YEAR	PRICE
B7A-6461102-A	A	Center Moulding	57-59	74.95 ea.
BM-7325662-B	B	Plastic Emblem	57-59	24.50 ea.
B6A-7925666-C	C	Chrome Bezel	57-59	19.95 ea.
BODY STYLE CODE		BODY STYLE	YEAR	
#59C		Fairlane Ranch Wagon		56
#64		Crown Victoria		56
#76		Convertible		56-59
#51A		Retractable		57-59
#57A		Fairlane 500 Town Victoria		57-58
#58B		Fairlane 500 Town Sedan		57
#63A		Fairlane 500 Club Victoria		57-58
#64B		Fairlane 500 Club Sedan		57

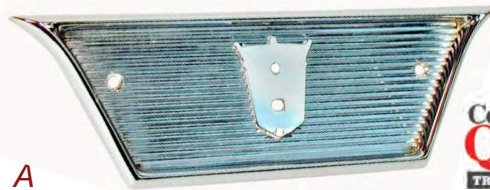

A



B



C



FENDER SKIRT

Fender Skirts include Rubber Seals but do NOT come with Brackets.

PART #	PIC	DESCRIPTION	NOTE	YEAR	PRICE
B5A-7027964-PR	D	Fender Skirts		55-56	159.95 pr.
B7A-7027964-PR	E	Fender Skirts		57-58	159.95 pr.
B5A-7327980-BK	F	Fender Skirt Brackets	Kit does (2) skirts	55-56	49.95 kit
370034-S8B	G	Fender Skirt Pins	Need (6)	59-64	2.95 ea.



FENDER STONE GUARD - Stainless

PART #	PIC	DESCRIPTION	YEAR	PRICE
B5A-7029212-PR	H	Fender Skirt Stone Guards	55-56	74.95 pr.
B5A-7025652-PR	I	Rear Fender Stone Guards	55-56	49.95 pr.

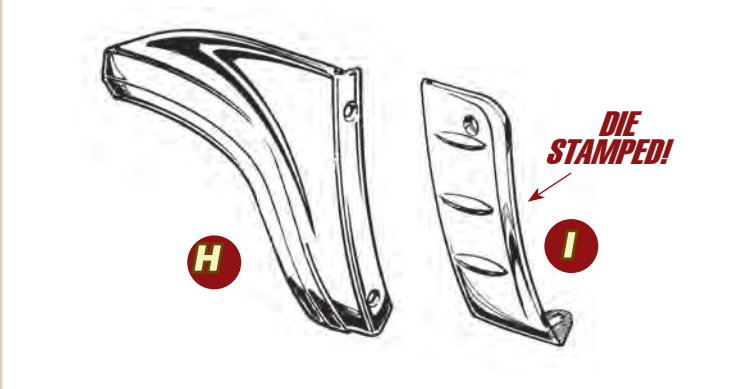

FENDER SKIRT RUBBER for Original Skirts

PART #	PIC	DESCRIPTION	YEAR	PRICE
BA-7327986-PR		For Original Skirts	52-54	19.95 pr.
*B5A-7327986-A		For Original Skirts	55-56	11.95 pr.
B7A-7327986-PR	J	Rubber Only	57-58	11.95 pr.
B9A-7327986-PR	K	Rubber Only	59	11.95 pr.
BC-7327986-PR		Mercury	52-54	24.95 pr.



CRESTMARK SEAT EMBLEM

Part #	B5A-7062186-DF	
Type	Seat only - w/ rivets	
Note	Passenger side of front	
Year	1954-56	
Price	9.95 ea.	

SEAT REGULATOR RELAY WIRE

Part #	B7A-14643-A	
Year	1957	
Price	39.95 ea.	



TRUNK MAT

Burtex Type

PART #	PIC	DESCRIPTION	YEAR	PRICE
B5A-7045455-AA	A		55-56	84.95 ea.
B7A-7045455-BB		All ex. Retractable & Custom	57-58	89.95 ea.
B7A-7045455-CC		Custom Only	57-58	94.95 ea.
B9A-7045455		All except Retractable	59	99.95 ea.

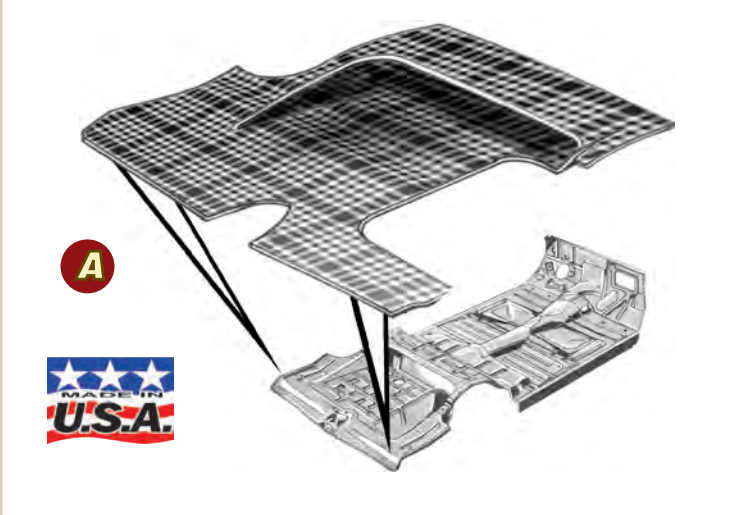

TRUNK LID ASSEMBLY

PART #	DESCRIPTION	YEAR	PRICE
BA-7040110-A		1952	249.95 ea.

TRUNK TORSION BAR ANTI-RATTLER

PART #	DESCRIPTION	YEAR	PRICE
B9A-16792-S	Trunk Torsion Bar Anti-Rattler	57-59	2.95 ea.



TRUNK LID BUMPER

Part #	BD-16754-A
Fits	All Except Sedan & Wagon
Year	1952-54
Price	11.95 pr.

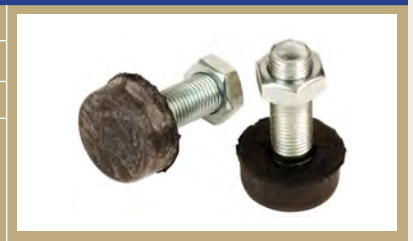

TRUNK SIDE BOARDS - PANELS

PART #	PIC	DESCRIPTION	YEAR	PRICE
BM-7045415-PR			53-54	29.95 pr.
B5A-7045415-PR			55	29.95 pr.
B6A-7045415-PR			56	29.95 pr.
B7A-7045415-PR	B	All ex. Retractable & Custom	57	29.95 pr.

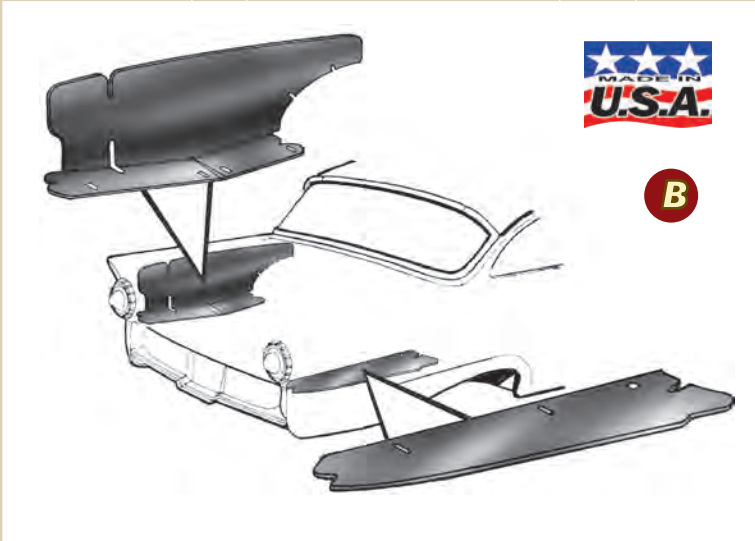

TRUNK LID SEAL

PART #	PIC	DESCRIPTION	YEAR	PRICE
BA-7043720		All except Retractable.	52-59	24.95 ea.



50,000 PART NUMBERS IN STOCK!
 SHOP ONLINE
www.dennis-carpenter.com



TRUNK LID EMBLEMS - Plastic

Emblems are manufactured in the USA!

PART #	PIC	FITS	YEAR	PRICE
0A-7042514-B	A	All ex. Fairlane Series 55-56	50-56	44.95 ea.
B5A-7042514-A	B	Fairlane Series	55	44.95 ea.
B7A-7042514-A	C	Custom Series	57	49.95 ea.
B6A-7042514-A	D	Fairlane Series	56	74.95 ea.
B7A-6442514-A	E	Fairlane 500	57	64.95 ea.



A



B



C



D



E



TRUNK LID BEZELS

Bezels include Fasteners and are manufactured in the USA!

PART #	PIC	FITS	YEAR	PRICE
BF-7043522-A	F	All	53-54	44.95 ea.
B5A-7042522-A	G	Fairlane Series	55	54.95 ea.
B7A-7043500-A	H	Custom Series	57	99.95 ea.
B6A-7043500-C	I	Fairlane 500	56	99.95 ea.
B7A-6443500-A	J	Fairlane 500	57	109.95 ea.



F



G



H



I



J



TRUNK LID LOCK

PART #	PIC	DESCRIPTION	NOTE	YEAR	PRICE
B5A-7043505-A	K	Trunk Lid Lock Cylinders	Original Style - w/ (2) Keys	52-59	24.95 ea.
B9A-6443505-A	L	Trunk Lid Lock Cylinders	Replacement - w/ (2) Keys	52-59	19.95 ea.
B5A-7043603-B	M	Trunk Lid Lock Cylinder Housing & Cover	Fairlane Except Retractable & Wagon	55-57	49.95 ea.
B5A-7043625-B	N	Lock Assembly to Trunk Lid Pad		55-57	3.50 ea.



K



L



M



N

TRUNK LID HANDLE PAD

PART #	PIC	DESCRIPTION	YEAR	PRICE
BA-7043531-D	A	All	52	9.95 ea.
BF-7043531-A	B	All	53	9.95 ea.
BM-7043531-A	C	All	54	9.95 ea.



TRUNK LID EMBLEM PAD

PART #	PIC	TYPE	YEAR	PRICE
0A-16675	D	All except S/D & S/W	50-54	0.95 ea.
B5A-16675-S	E	Fairlane Series	55	0.95 ea.
B6A-7004541-S	F	Fairlane Series	56	2.95 ea.
B7A-6443545-A	G	Fairlane Series	57	0.50 ea.
B5A-7043531-A	H	Mainline, Customline, 2-Dr. & 4-Dr. Sedan	55	9.95 ea.
B7A-7043531-A	I	Custom Series	57	9.95 ea.



TRUNK LID SCRIPTS

Trunk Lid Scripts include Fasteners.

PART #	PIC	DESCRIPTION	YEAR	PRICE
BF-7042527-A	J	"Fordomatic"	53-55	24.95 ea.
BF-7042528-A	K	"Overdrive"	53-55	24.95 ea.
B5A-7042528-B	L	"Fairlane"	55	29.95 ea.
B8A-6442528-A	M	"Fairlane"	58	39.95 ea.
B9A-5842528-A	N	"Fairlane"	59	39.95 ea.



TRUNK LID EMBLEMS - MERCURY

PART #	PIC	DESCRIPTION	YEAR	PRICE
8M-7042530	O	Mercury	49,52	84.95 ea.
BG-7042530-A	P	Mercury	53-54	99.95 ea.
BV-7042530-A	Q	Mercury	55	69.95 ea.
BU-7042530-C	R	Mercury	56	149.95 ea.



ROOF EMBLEM & BEZEL

Victoria Only - (2) per car

PART #	PIC	DESCRIPTION	YEAR	PRICE
1A-7004539	S	Emblem	52-54	29.95 ea.
1A-7004540-A	T	Bezel - Plastic	52-54	29.95 ea.



RETRACTABLE ROOF SIDE EMBLEM

Fasteners not included.



PART #	PIC	DESCRIPTION	YEAR	PRICE
BM-7325662-B	U	Plastic Emblem	57-59	24.50 ea.
B6A-7925666-C	V	Chrome Bezel	57-59	19.95 ea.



"SKYLINER" ROOF SCRIPT

PART #	DESCRIPTION	YEAR	PRICE
B7A-5150399-PR	- Gold Color - Pressure Die Cast and Plated - Includes Fasteners	57-59	99.95 pr.



\$9.99 or **\$14.99** **FLAT RATE SHIPPING**
See shipping page for details.

GLASS TOP RUBBER

PART #	PIC	DESCRIPTION	YEAR	PRICE
B4A-6450080-A	W	Ford	54	99.95 ea.
B5A-6450080-B		Ford	55-56	99.95 ea.
BU-6450080-A		Mercury	55-56	109.95 ea.

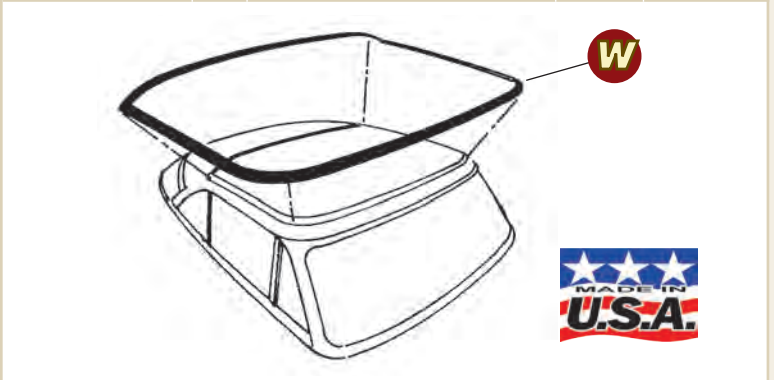

ROOF RAIL WEATHERSTRIP

PART #	PIC	DESCRIPTION	YEAR	PRICE
*BF-6051222-PR		2-Door Hardtop	52-54	219.95 pr.
B5A-6451222-PR	X	Crown Victoria (Cloth covered like original)	55	99.95 pr.

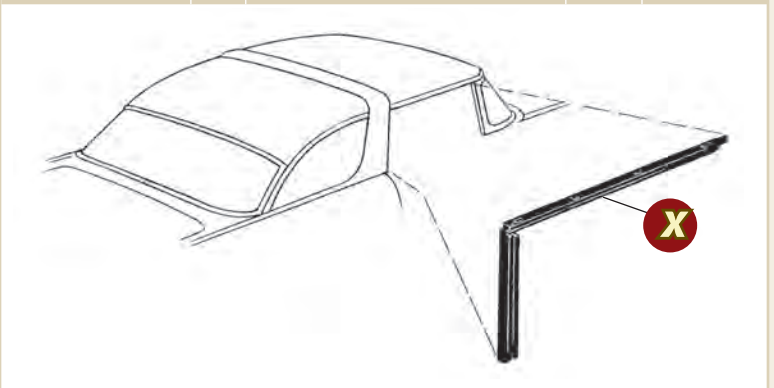

ROOF RAIL SIDE SEALS

PART #	PIC	DESCRIPTION	YEAR	PRICE
B6A-6451676-PR	Y	Roof Side Rail Front Corner Seal - Glues on body - Crown & Hardtop	56	19.95 pr.
B6A-6451678-PR	Z	Roof Side Rail Center Seal - Fits Hardtop Only	56	19.95 pr.

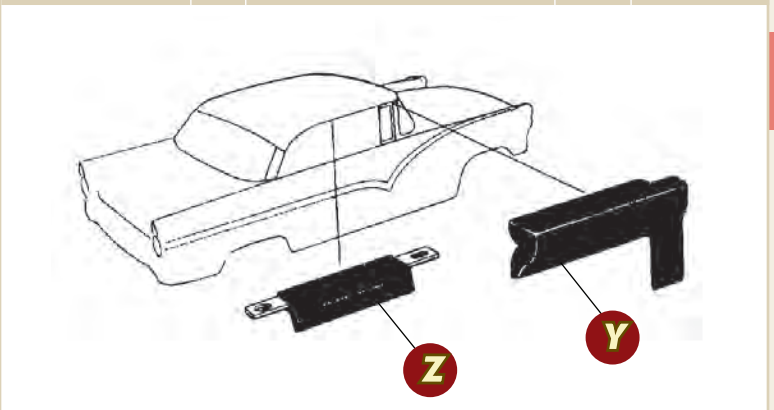

CONVERTIBLE TOP WEATHERSTRIPPING

Convertible Top Kits are all cloth covered and are exact of original!
Mounting bolts not included.

PART #	PIC	DESCRIPTION	YEAR	PRICE
BA-6451562-KIT		(10) pieces	52-54	349.95 kit
B5A-6451562-KIT	A	(7) pieces	55-56	349.95 kit
B7A-6451562-KIT		(7) pieces	57-58	349.95 kit
B9A-7651562-KIT		(7) pieces	59	349.95 kit

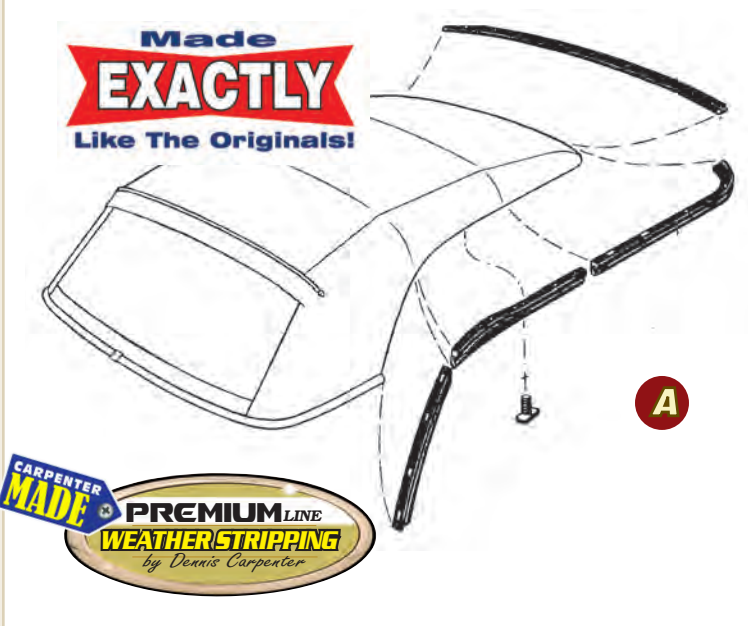

CONVERTIBLE TO TOP IRON BOLTS

PART #	PIC	DESCRIPTION	TYPE	YEAR	PRICE
*353014-S	B	(16) pieces per car	Mercury	52-58	1.50 ea.
*353013-L	C	(6) pieces per car	Mercury	52-58	0.95 ea.
*353014-S	B	(22) pieces per car	Ford	52-58	1.50 ea.
353014-SET	B	(22) piece KIT	Ford	52-58	21.95 kit



TOP IRONS TO DOOR GLASS WEATHER STRIPPING SHIM

Part #	B7A-6351630-S
Type	Rubber
Note	8" length
Fits	Retractable & Convertible
Year	1957-59
Price	9.95 ea.



HEADER BOW SEALS

PART #	PIC	DESCRIPTION	YEAR	PRICE
BA-7651330-B		On Top Header	52-54	14.95 ea.
*B5A-7651338-A		On Top Header	55-56	9.95 ea.
B7A-7651338-A		On Top Header	57-58	9.95 ea.
*BA-7651338-B		On top of windshield frame	52-54	14.95 ea.

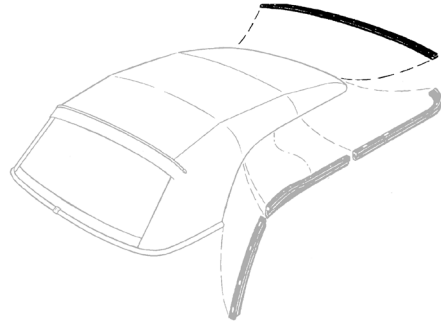

HEADER CHROME TO TOP OF WINDSHIELD SEAL

Part #	B7A-7603144-S
Year	1957-58
Price	7.95 ea.

FOLDING TOP SIDE ARM BUMPERS

Part #	B5A-7629986-A
Fits	Convertible
Year	1955-58
Price	14.95 pr.



FOLDING TOP COMPARTMENT WATERSHIELD ASSEMBLY

Part #	B5A-7654682-PR
Year	1955-56
Price	49.95 pr



TOP CONTROL SWITCH TO TOP MOTOR WIRE

Part #	B7A-14362-A
Fits	Convertible
Year	1957
Price	89.95 ea.



INTERIOR TRIM SCREW KITS

PART #	PIC	DESCRIPTION	YEAR	PRICE
BA-7080902	D	2-Door Sedan	52	16.95 kit
BA-7380902		4-Door Sedan	52	16.95 kit
BA-6080902		Victoria Hardtop	52	16.95 kit
BA-7680902		Convertible	52	16.95 kit
BF-7080902		2-Door Sedan	53	16.95 kit
BF-7680902		Convertible	53	16.95 kit
BF-7380902		4-Door Sedan	53	16.95 kit
BF-6080902		Victoria	53	16.95 kit
B4A-6080902		2-Door Hardtop & Victoria	54	16.95 kit
BM-7680902		Convertible	54	16.95 kit
B4A-7080902		2-Door Sedan	54	16.95 kit
B4A-7380902		4-Door Sedan	54	16.95 kit
B5A-6480902		Crown Victoria	55	16.95 kit
B5A-6080902		2-Door Victoria	55	16.95 kit
B5A-7080902		2-Door Sedan	55	16.95 kit
B5A-7680902		Convertible	55	16.95 kit
B5A-7380902		4-Door Sedan	55	16.95 kit
B6A-7080902		2-Door Sedan	56	16.95 kit
B6A-7380902		4-Door Sedan	56	16.95 kit
B6A-6080902		2-Door Victoria	56	16.95 kit
B6A-7680902		Convertible	56	16.95 kit
B6A-6480902		Crown Victoria	56	16.95 kit
B7A-5180902		Retractable	57	26.95 kit
B7A-6080902		2 dr. Victoria Hardtop	57	16.95 kit
B7A-7080902	D	2 dr. Sedan	57	16.95 kit
B7A-7380902		4 dr. Sedan	57	16.95 kit
B7A-7680902		Convertible	57	16.95 kit
B8A-5180902		Retractable	58	26.95 kit
B8A-6080902		2 dr. Hardtop Victoria	58	16.95 kit
B8A-7080902		2 dr. Sedan	58	16.95 kit
B8A-7380902		4 dr. Sedan	58	16.95 kit
B8A-7680902		Convertible	58	16.95 kit
B9A-5180902		Retractable	59	26.95 kit
B9A-6080902		2 dr. Hardtop	59	16.95 kit
B9A-7080902		2 dr. Sedan	59	16.95 kit
B9A-7380902		4 dr. Sedan	59	16.95 kit
B9A-7680902		Convertible	59	16.95 kit
371211-S		Back-Up Light Lens Screws - set of (6)	59	3.95 set



D



DENNIS-CARPENTER.COM

EDSEL

1958-60



ONLINE

Fully secure ordering - Open 24/7 - Find parts by year, description, or category.

Dennis Carpenter carries a great selection of Edsel parts that are now exclusively listed online.

You can easily order your Edsel parts online or you can gather your part numbers from our website, give us a call and place your order by phone.



For Orders Only: 1-800-476-9653
Shop Online at DENNIS-CARPENTER.COM

Floor Pans - FRONT

PART #	PIC	TYPE	SIDE	YEAR	PRICE
BA-7011135-L	A	Front	Left	52-54	89.95 ea.
BA-7011135-R		Front	Right	52-54	89.95 ea.
B5A-7011135-L		Front	Left	55-56	89.95 ea.
B5A-7011135-R		Front	Right	55-56	89.95 ea.
B7A-7011135-L	B	Front	Left	57-59	89.95 ea.
B7A-7011135-R		Front	Right	57-59	89.95 ea.

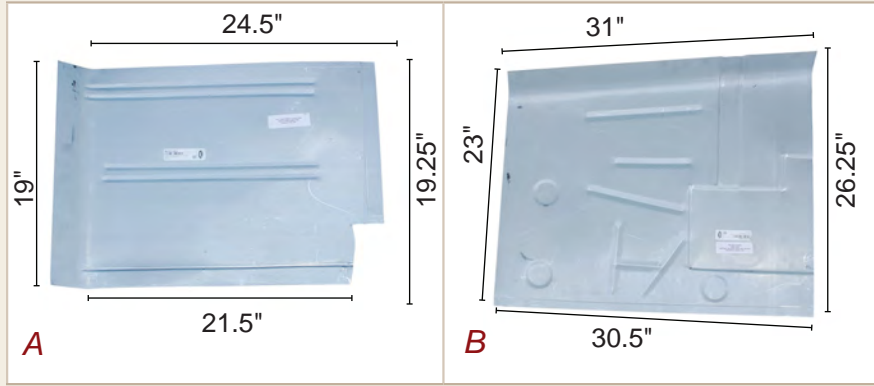

TOE BOARD

PART #	PIC	DESCRIPTION	YEAR	PRICE
BA-7001611-L	F	Left Front	52-54	89.95 ea.
BA-7001611-R		Right Front	52-54	89.95 ea.
B5A-7001611-L	G	Left Front	55-56	89.95 ea.
B5A-7001611-R		Right Front	55-56	89.95 ea.
B7A-7001611-L	H	Left Front	57-59	89.95 ea.
B7A-7001611-R		Right Front	57-59	89.95 ea.

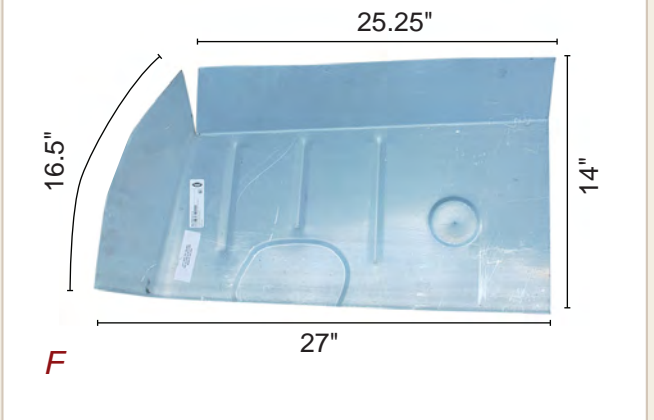

Floor Pans - REAR

PART #	PIC	DESCRIPTION	YEAR	PRICE
BA-7012136-L	C	Left Rear	52-54	89.95 ea.
BA-7012136-R		Right Rear	52-54	89.95 ea.
B5A-7012136-L	D	Left Rear	55-56	89.95 ea.
B5A-7012136-R		Right Rear	55-56	89.95 ea.
B7A-7012136-L	E	Left Rear	57-59	89.95 ea.
B7A-7012136-R		Right Rear	57-59	89.95 ea.

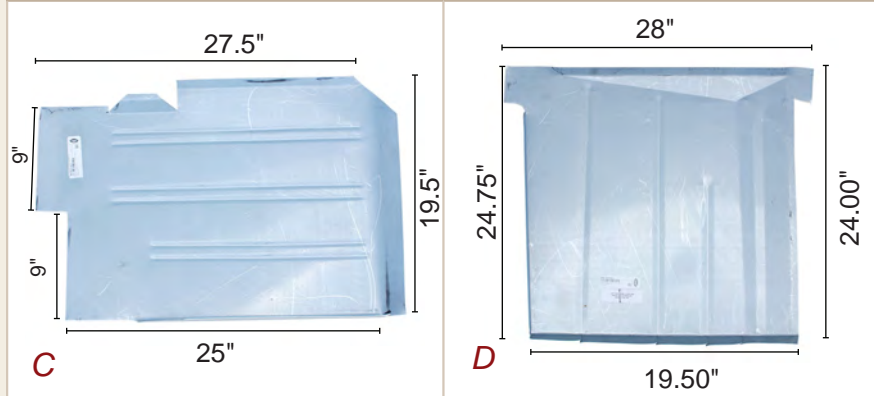

Some listed sheet metal parts have multiple applications and may require minor cutting or modification to accommodate your particular vehicle. All sheet metal requires fitting for proper placing. all sheet metal requires welding to accomplish installation. Painted or otherwise modified sheet metal is not returnable regardless of the reason.

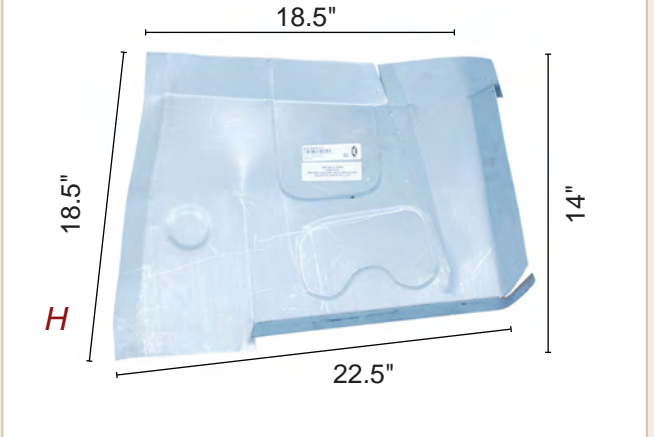
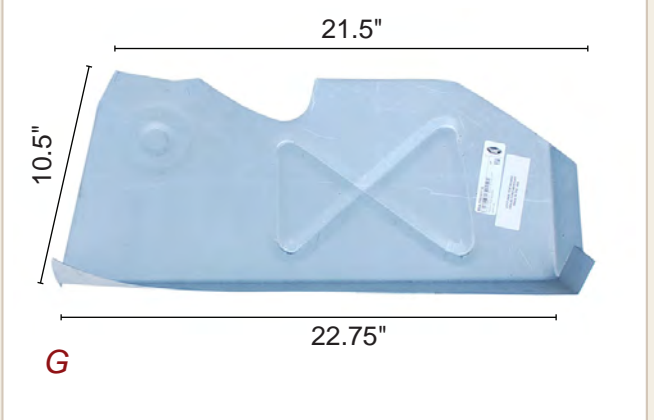

50,000 PART NUMBERS IN STOCK! **SHOP ONLINE**
www.dennis-carpenter.com



Show Schedule

SHOW NAME	DATE	
Bronco Super Celebration	Townsend, TN	APR 19-22, 2017
Spring Carlisle	Carlisle, PA	APR 19-23, 2017
Pate Swap Meet	Fort Worth, TX	APR 27-30, 2017
Ford/Fordson Annual Meet	Brownsboro, IN	May 11-13, 2017
F-100 Super Nationals	Lebanon, TN	MAY 19-20, 2017
All Ford Nationals	Carlisle, PA	JUN 2-4, 2017
Early Ford V-8 Club Eastern National Meet	Chantilly, VA	JUN 7-11, 2017
Cushman Nationals	Hutchinson, KS	JUN 11-15, 2017
LA Roadster Show	Pomona, CA	JUN 17-18, 2017
Back to the 50's	Saint Paul, MN	JUN 23-25, 2017
Old Threshers Reunion	Denton, NC	JUN 30 - JUL 4, 2017
Goodguys Heartland Nationals	DesMoines, Iowa	JUN 30 - JUL 2, 2017
Iola Old Car Swap Meet	Iola, WI	JUL 6-8, 2017
Syracuse Nationals	Syracuse, NY	JUL 14-16, 2017
Vintage Motorbike Meet	Portland, IN	JUL 19-22, 2017
NSRA Street Rod Nationals	Louisville, KY	AUG 3-6, 2017
Tri-State Gas Engine & Tractor	Portland, IN	AUG 23-26, 2017
Frog Follies	Evansville, IN	AUG 25-27, 2017
Shades of The Past	Pigeon Forge, TN	SEP 8-9, 2017
Fall AutoFair Charlotte	Charlotte, NC	SEP 21-24, 2017
Goodguys Lone Star Nationals	Fort Worth, TX	SEP 29 - OCT 1, 2017
Fall Hershey Swap Meet	Hershey, PA	OCT 4-7, 2017
Cruisin The Coast	Biloxi, MS	OCT 5-7, 2017
Goodguys Southeast Nationals	Charlotte, NC	OCT 20-22, 2017
Fall Moultrie Swap Meet	Moultrie, GA	NOV 17-19, 2017
Daytona Turkey Rod Run	Daytona Beach, FL	NOV 23-26, 2017



**CARPENTER
MADE**

**PREMIUM LINE
WEATHERSTRIPPING**
by Dennis Carpenter



Dennis Carpenter Ford Restoration designs, engineers and manufactures it's own brand of quality Weather Stripping, 99% of which is made here in Concord, NC in our Rubber Extrusion department.

- Back Window Rubber
- Trunk Rubber
- Vent Window Seals
- Windshield Rubber
- Door Seals

For Orders Only: 1-800-476-9653
Shop Online at DENNIS-CARPENTER.COM

WAGON TAILGATE & LIFTGATE SEALS

PART #	PIC	DESCRIPTION	FITS	NOTE	YEAR	PRICE
*B5A-5941608-D	A	Lower Tailgate Seal	#59 2-Dr. Ranch Wagon		55-56	49.95 ea.
*B5A-5941608-D	A	Lower Tailgate Seal	#79 4-Dr. Wagon		55-56	49.95 ea.
*B5A-5941614-B	B	Upper Tailgate Seal	#59 2-Dr. Ranch Wagon		55-56	59.95 ea.
*B5A-5941614-B	B	Upper Tailgate Seal	#79 4-Dr. Wagon		55-56	59.95 ea.
*B5A-5943726-A	C	Outer Tailgate Seal	#59 2-Dr. Ranch Wagon	Cut to 43.34"	53-54	9.95 ea.
*B5A-5943726-A		Outer Tailgate Seal	#79 4-Dr. Wagon	Cut to 43.34"	53-54	9.95 ea.
*B5A-5943726-A	C	Outer Tailgate Seal	#59 2-Dr. Ranch Wagon	46"L	55-57	9.95 ea.
*B5A-5943726-A		Outer Tailgate Seal	#66 Ranchero	46"L	57	9.95 ea.
*B5A-5943726-A		Outer Tailgate Seal	#79 4-Dr. Wagon	46"L	55-57	9.95 ea.
*B5A-5943706-C		Lift Gate Seal on Body	#59 2-Dr. Ranch Wagon		55-56	19.95 ea.
*B5A-5943706-C		Lift Gate Seal on Body	#79 4-Dr. Wagon		55-56	19.95 ea.
B7A-5943706-A	D	Lift Gate Seal on Body	Ranch & Station Wagon		57-58	13.95 ea.

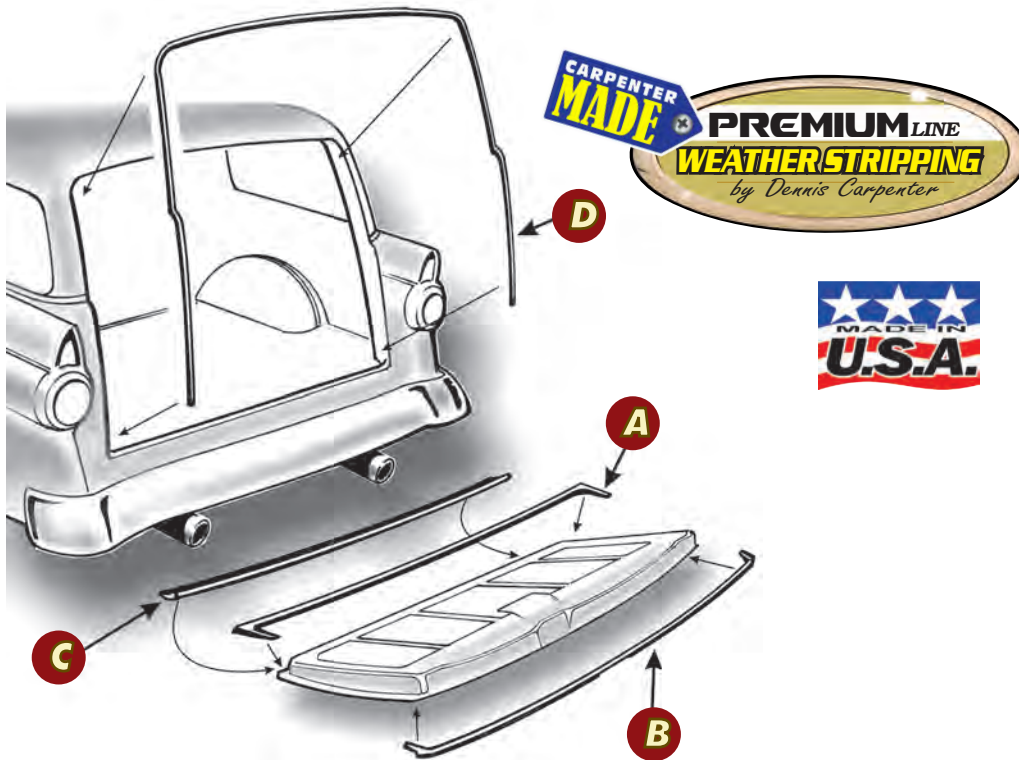

WAGON TAILGATE STRIKER PLATE INSERTS

PART #	PIC	DESCRIPTION	YEAR	PRICE
B5A-5943146-A	E	RH	55-58	12.95 ea.
B5A-5943147-A		LH	55-58	12.95 ea.

TAILGATE & IGNITION LOCK CYLINDER SET

Part #	B9A-5943505-SET
Note	Has Edsel Style Keys
Fits	Wagon
Year	1959
Price	74.95 set



FOLD DOWN SEAT BUMPER

Part #	Year	Price
0A-7961333-PR	1950-64	7.50 pr.



SEAT STOPS

For Front Seats - 2 Dr. Cars
White plastic w/ Screws

Part #	Year	Price
B5A-7061064-A	1953-59	9.95 ea.



Window Crank & Door Handle ESCUTCHEON

Ford & Mercury

Part #	Year	Price
1A-7922618	1951-54	12.50 ea.



Sliding QUARTER GLASS STOPS

Ford & Mercury
Fasteners not included.

Part #	Year	Price
357385-S	1950-54	9.95 pr.

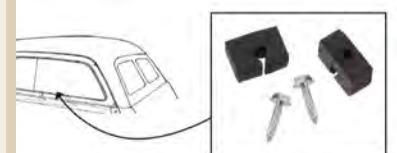



Station Wagon BACK WINDOW SEAL - FORD

PART #	PIC	NOTE	TYPE	FITS	YEAR	PRICE
BA-5942084-B			Ford	#59 Mainline Ranch Wagon	52-54	59.95 ea.
BA-5942084-B			Ford	#78 Sedan Delivery	52-54	59.95 ea.
BA-7942084-B			Ford	#79 All 4-Dr Wagons	52-54	69.95 ea.
BA-7942084-B			Ford	#59B Customline Ranch Wagon	54	69.95 ea.
B5A-5942084-C	F		Ford	#59 2-Dr Ranch Wagons	55-56	79.95 ea.
B5A-5942084-C	F		Ford	#78 Sedan Delivery-before 6-1-56	55-56	79.95 ea.
B5A-5942084-C	F	Back Window (when rear door is used)	Ford	#79 4-Door Wagon	55-56	79.95 ea.
B5A-5942084-D		w/ Groove for Stainless Molding	Ford	#59B Customline Ranch Wagon	55-56	79.95 ea.
B5A-5942084-D		w/ Groove for Stainless Molding	Ford	#59C Fairlane Ranch Wagon	55-56	79.95 ea.
B5A-5942084-D		w/ Groove for Stainless Molding	Ford	#59A Mainline Ranch Wagon	56	79.95 ea.
B5A-5942084-D		w/ Groove for Stainless Molding	Ford	#78 Sedan Delivery-from 6-1-56	56	79.95 ea.
B5A-5942084-D		w/ Groove for Stainless Molding	Ford	#79 4-dr. Wagon	55-56	79.95 ea.
B7A-5942084-A	F		Ford	#59 2-dr Ranch Wagon	57-58	59.95 ea.
B7A-5942084-A	F		Ford	#79 4-dr Ranch Wagon	57-58	59.95 ea.
B7A-7842084-A		Back Window w/ Rear Door - 3 pc. set	Ford	#59 2 dr. Ranch Wagon	57	174.95 set
B7A-7842084-A		Back Window w/ Rear Door - 3 pc. set	Ford	#79 4 dr. Ranch Wagon	57	174.95 set
B7A-7842084-A		Rear Door - 3 pc. set	Ford	#78 Sedan Delivery or Courier	57-58	174.95 set
BA-7942084-B			Mercury	#79B 8-Passenger Wagon	52-54	69.95 ea.
BA-7942084-B			Mercury	#79D 6-Passenger Wagon	52	69.95 ea.
B5A-5942084-D		w/ Groove for Stainless Molding	Mercury	#79 4-dr. Station Wagon	55-56	79.95 ea.

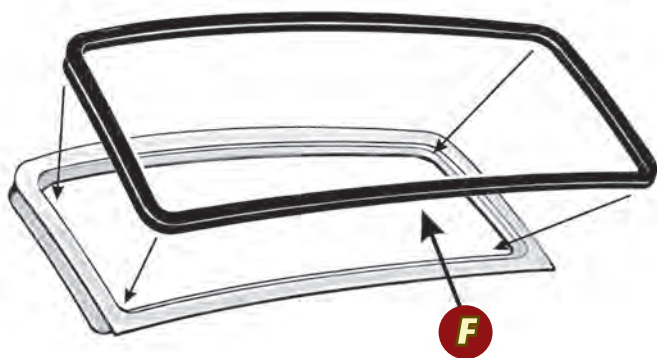

REAR CARGO AREA MAT (Tailgate & Rear of Back Seat)

PART #	PIC	DESCRIPTION	YEAR	PRICE
*0M-7901354		Brown Rubber w/ Grooves	50-64	199.95 ea.

Mat Measures - 59.76" x 43.75". Order accordingly.
You may need more than (1) mat to complete all areas.



STATION WAGON DOOR SCRIPTS

Fasteners Included

PART #	PIC	DESCRIPTION	YEAR	PRICE
1A-7920978-PR		"Country Squire"	51-54	149.95 pr.



TAILGATE LOCK CYLINDER HOLD ORNAMENT

Part #	B7A-6643830-A
Type	Chrome w/ Red
Fits	For Ranchero
Year	1957-59
Price	44.95 ea.



ENGINE COMPARTMENT DECALS

PART #	PIC	DESCRIPTION	YEAR	PRICE
DF-33	A	Coil	56-64	4.95 ea.
DF-131	B	Starter	56-57	4.95 ea.
DF-38	C	Heater Box Removal Instruction	55-56	3.95 ea.
DF-683	D	Heater Box Removal Instruction	52-54	3.95 ea.
DF-358	E	A/C Compressor	55-56	4.95 ea.
DF-623	F	Windshield Washer Bracket	52-54	4.95 ea.

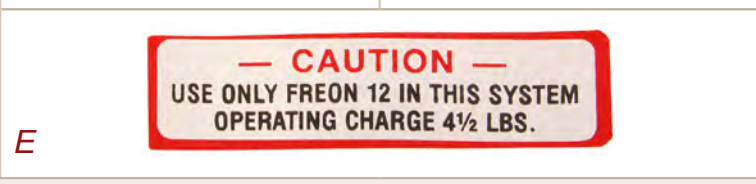
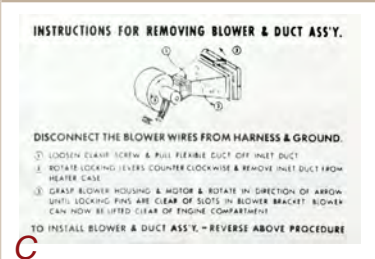
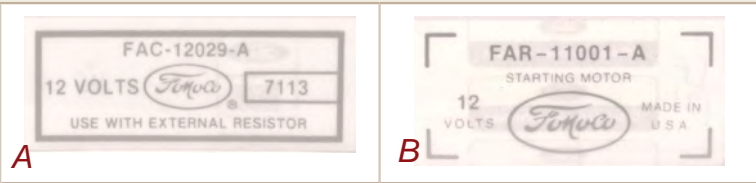

VOLTAGE REGULATOR DECALS

PART #	PIC	DESCRIPTION	YEAR	PRICE
DF-109	G	Ford 6-volt Voltage Regulator Decal	52-54	4.95 ea.
DF-84	H	Ford 6 Volt Voltage Regulator Decal	55	4.95 ea.
DF-32	I	Ford Voltage Regulator Decal	56-57	4.95 ea.
CC-104		Voltage Regulator Metal Tag	49-53	6.50 ea.
DF-107	J	Voltage Regulator Decal	58-61	4.95 ea.



AIR CLEANER DECALS

PART #	PIC	DESCRIPTION	YEAR	PRICE
DF-286	K	Oil Bath Air Cleaner Decal	52-53	5.95 ea.
DF-231	L	Oil Bath Air Cleaner Decal	54	6.50 ea.
DF-232	M	Oil Bath Air Cleaner Decal	54	5.50 ea.
DF-67	N	Oil Bath Air Cleaner Decal	55-56	6.95 ea.
DF-287	O	Air Cleaner Service Instruction	52-53	5.95 ea.
DF-66	P	Air Cleaner Service Instruction	55-56	6.95 ea.
DF-83	Q	Air Cleaner Service Instructions Decal	57-64	4.95 ea.
DF-430	R	Interceptor Air Cleaner Decal - Small	58-59	5.95 ea.

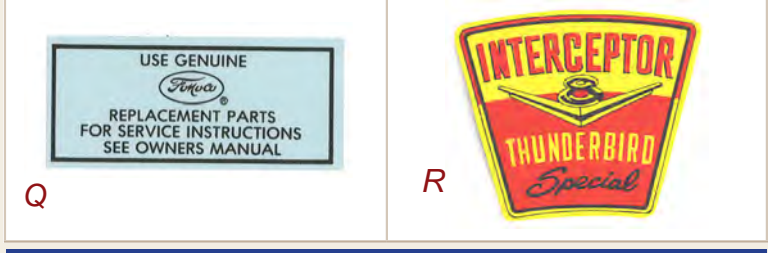
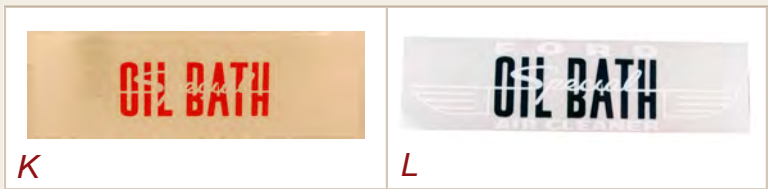

FORD PAINT "OK" DECAL SET

PART #	PIC	DESCRIPTION	YEAR	PRICE
DF-235	S	Ford Paint "OK" Decal Set	55	4.50 ea.
DF-236	T	Ford Paint "OK" Decal Set	56	4.50 ea.

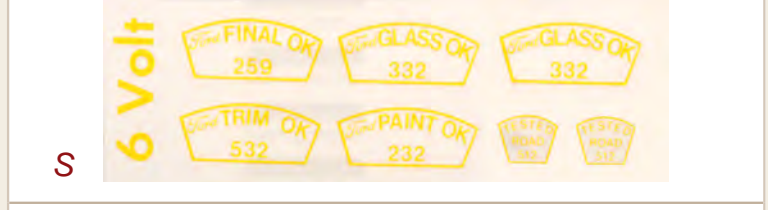

GENERATOR DECALS & TAGS

PART #	PIC	DESCRIPTION	YEAR	PRICE
DF-68	U	Ford 12 Volt Generator Decal	56	4.95 ea.
DF-69	V	Generator Decal	57	4.95 ea.
DF-1134	W	Generator Warning Tag - Red - 6V	52-55	4.95 ea.
DF-1125	X	Generator Warning Tag - Green - 12V	56-64	3.50 ea.

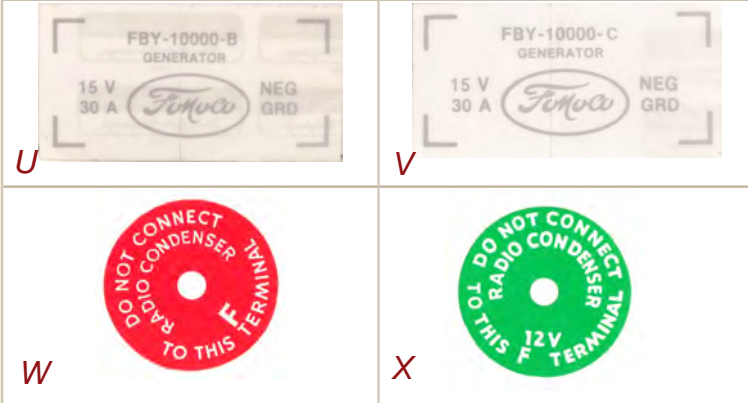

OIL FILTER DECALS

PART #	PIC	DESCRIPTION	YEAR	PRICE
DF-375	Y	Ford Oil Filter Decal Set	52-53	11.95 set
DF-64	Z	Ford Oil Filter Decal	40-53	4.95 ea.
DF-82	A1	Ford Oil Filter Canister Decal	54-56	6.95 ea.



VALVE COVER DECALS

PART #	PIC	DESCRIPTION	YEAR	PRICE
DF-70	A	272 Cubic Inch Valve Cover Decal	55	11.95 pr.
DF-71	B	312 Cubic Inch Valve Cover Decal	55-56	11.95 pr.
DF-72		292 Cubic Inch Valve Cover Decal	56	11.95 pr.
DF-230		239 Cubic Inch Valve Cover Decal	54	11.95 pr.
DF-450		I-Block Valve Cover Decal	54	6.95 ea.
DF-885		Ford I-6 Valve Cover Decal	55-56	6.95 ea.



\$9.99 *or* **\$14.99** **FLAT RATE SHIPPING**
See shipping page for details.

Battery Warranty Certificate & Card

PART #	PIC	DESCRIPTION	YEAR	PRICE
DF-9	K	Battery Warranty Certificate	39-53	3.95 ea.
DF-117	L	Battery Warranty Card	56-57	3.95 ea.

PAMPHLETS, SHEETS, AND TAGS

PART #	PIC	DESCRIPTION	YEAR	PRICE
DF-445	A	"Ford Service Policy" Pamphlet	54-55	3.95 ea.
DF-29	B	"Ford Service Policy" Pamphlet	56	3.95 ea.
DF-121	C	"How to Service your Tubeless Tires" Pamphlet	55-56	3.95 ea.
DF-151	D	"About the new Tubeless Tires" Pamphlet	55-56	3.95 ea.
DF-152	E	Ford New Car Delivery Report Pamphlet	55-56	3.95 ea.
DF-76	F	Ford Owners Manual Maintenance Insert Sheet	55-57	4.50 ea.
DF-156	G	Ford Electric Clock Instructions	49-56	4.50 ea.
DF-120	H	FoMoCo Anti-Freeze Tag	54-59	4.95 ea.
DF-154	I	Glare Proof Mirror Instruction Tag	50-56	4.95 ea.
DF-229	J	Y - Block Foundry Tag	54-59	4.95 ea.



K



L



A



B



C



D



E

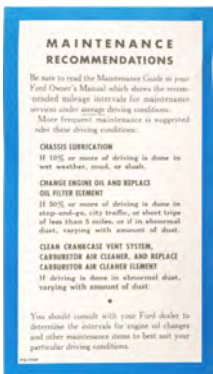

F



G

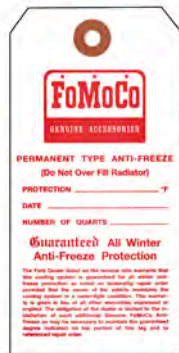

H



I



J

INTERIOR DECALS

PART #	PIC	DESCRIPTION	YEAR	PRICE
DF-93	M	Ford Life Guard Body Decal	56-57	5.95 ea.
DF-275	N	Transistorized Radio Decal	57-59	4.95 ea.
DF-359	O	Ford A/C Glove Box Service Decal	55-56	4.95 ea.
DF-1129	P	Convertible Top Warning Decal	55-56	4.95 ea.
DF-180	Q	Life Guard Door Lock Decal	57	6.95 kit



M

WARNING

This is a transistor powered radio. Do not attempt to service without reference to Motorola service manual for this model. Operate only with (+) voltage to 'A' lead and (-) to chassis. When soldering disconnect radio from supply voltage. When checking for noise do not tap tubes, rather tap housing with rubber mallet.

LABEL 54P539787 O.C.L. Printed in U.S.A.

N

FORD SELECT AIRE SYSTEM

COMPRESSOR MUST BE DISCONNECTED FOR COLD WEATHER HEATER OPERATION (TEMP. BELOW 45°)

O

CAUTION

UNLATCH HEADER LOCKS AND ACTUATE TOP MOTOR TO LIFT ROOF AT LEAST 6" ABOVE WINDSHIELD BEFORE OPENING OR CLOSING REAR WINDOW ZIPPER. LOWER REAR WINDOW BEFORE LOWERING TOP.

SEE OWNERS MANUAL FOR DETAILED OPERATING INSTRUCTIONS.

P



Q

RADIO DECALS

PART #	PIC	DESCRIPTION	YEAR	PRICE
DF-223	R	Deluxe Radio Owners Manual	53	4.95 ea.
DF-273	S	Ford Radio Schematic Decal	56	3.95 ea.
DF-274	T	Radio Schematic Decal	57-59	3.95 ea.



R

TUBE LOCATIONS



This apparatus uses inventions of United States patents licensed by Radio Corporation of America. Patent numbers supplied upon request.

MOTOROLA

S

TUBE LOCATIONS



THIS APPARATUS IS LICENSED UNDER THE UNITED STATES PATENT RIGHTS OF RADIO CORPORATION OF AMERICA. PATENT NUMBERS SUPPLIED UPON REQUEST.

LABEL 54A53955 B CL. PRINTED IN U.S.A.

T

GLOVE BOX DECALS

PART #	PIC	DESCRIPTION	YEAR	PRICE
DF-81	U	Ford Automatic Transmission	54-59	4.95 ea.
DF-130	V	Chrome Care Instruction	51-53	3.95 ea.
DF-94	W	Ford Tire Pressure	52-56	4.95 ea.
DF-271	X	Tire & Oil Pressure	52	4.95 ea.
DF-1350	Y	Tire & Oil Pressure	53-54	4.95 ea.
DF-288	Z	Tire Pressure	57-58	4.95 ea.

USE ONLY AUTOMATIC TRANSMISSION FLUID TYPE "A"

CHECK TRANSMISSION FLUID LEVEL TO FULL MARK ON INDICATOR WITH TRANSMISSION AT NORMAL OPERATING TEMPERATURE AND ENGINE ON SLOW IDLE WITH SELECTOR LEVER IN P POSITION

U

IMPORTANT TO OWNERS

THE NATIONAL DEFENSE REQUIREMENTS HAVE PLACED RESTRICTIONS ON USE OF NICKEL IN FINISHING AUTOMOTIVE BRIGHT METAL PARTS. AN ALTERNATE METHOD OF CHROME OVER COPPER PLATING HAS BEEN USED IN FINISHING SOME OF THE BRIGHT METAL PARTS ON THIS CAR.

PROPER CAUTION AND PERIODIC CARE ON YOUR PART WILL PRESERVE THEIR LIFE AND BEAUTY.

PLEASE SEE INSTRUCTIONS COMPARTMENT

V

ENGINE OIL

NOT LOWER THAN 32°F SAE 20 OR 20W
DOWN TO MINUS 10°F SAE 10W
BELOW MINUS 10°F SAE 5W

TIRE PRESSURE

TIRE SIZE	FRONT LBS.	REAR LBS.
6:00 X 16-4 PLY	28	25
6:70 X 15-4 PLY	26	23
7:10 X 15-4 PLY	24	21

and when service is needed specify Genuine Ford Parts

W

ENGINE OIL

NOT LOWER THAN 32°F SAE 20 OR 20W
DOWN TO MINUS 10°F SAE 10W
BELOW MINUS 10°F SAE 5W

TIRE PRESSURES

TIRE SIZE	FRONT LBS.	REAR LBS.
6:00 X 16-4 PLY	28	25
6:70 X 15-4 PLY	26	23
7:10 X 15-4 PLY	24	21

... and when service is needed specify Genuine Ford Parts

X

ENGINE OIL

NOT LOWER THAN 32°F SAE 20 OR 20W
DOWN TO MINUS 10°F SAE 10W
BELOW MINUS 10°F SAE 5W

TIRE PRESSURE

TIRE SIZE	FRONT LBS.	REAR LBS.
6:70 X 15-4 PLY	26	23
7:10 X 15-4 PLY	24	21
7:10 X 15-4 PLY*	23	20

*RANCH WAGON AND SEDAN DELIVERY ONLY

and when service is needed specify Genuine Ford Parts

Y

ENGINE OIL

ABOVE - 32°F SAE 30 OR 20W
ABOVE - 10°F SAE 15W
BELOW - 10°F SAE 5W

TIRE PRESSURES

7:36 X 14-4 PLY FRONT 21 LBS. REAR 21 LBS.
8:00 X 14-4 PLY FRONT 20 LBS. REAR 21 LBS.

AND WHEN SERVICE IS NEEDED SPECIFY GENUINE FORD PARTS

Z



JACK INSTRUCTION DECALS

PART #	PIC	DESCRIPTION	YEAR	PRICE
DF-396	A	Ford Jack Instruction Decal	52-53	3.95 ea.
DF-50	B	Ford Jack Instruction Decal	54-56	3.95 ea.
DF-268	C	Station Wagon Jack Instruction Decal	52-56	3.95 ea.

A

B

C

JACK INSTRUCTION DECALS

PART #	PIC	DESCRIPTION	YEAR	PRICE
DF-47	D	Retractable Jack Instructions	57	3.95 ea.
DF-48	E	Retractable Jack Instructions	58	3.95 ea.
DF-49	F	Retractable Jack Instructions	59	3.95 ea.
DF-415	G	Tire Storage Instructions	52-53	4.95 ea.

D

E

F

G

RETRACTABLE DECALS

PART #	PIC	DESCRIPTION	YEAR	PRICE
DF-262	H	Retractable Storage Instructions Decal	57-59	4.95 ea.
DF-127	I	Retractable Motor Decal Kit	57-59	5.95 ea.

H

I

HEMMINGS
Motor News Magazine
 Current Issue of the
"CAR COLLECTOR'S BIBLE"

Part #	HEMM
Price	\$6.00 ea.

"The Complete Ford Owners Handbook of Repair & Maintenance"

Part #	CA-3211
Year	1932-55
Price	27.50 ea.



"The Official 12 Volt Conversion Guide"

Part #	CA-3200-4
Author	Randy Rundle
Price	9.95 ea.

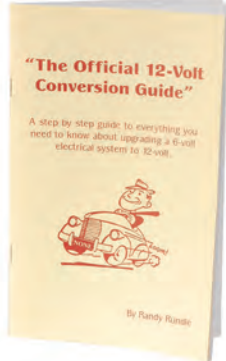

"Fords of the Fifties"

Part #	CA-5000
Price	24.95 ea.

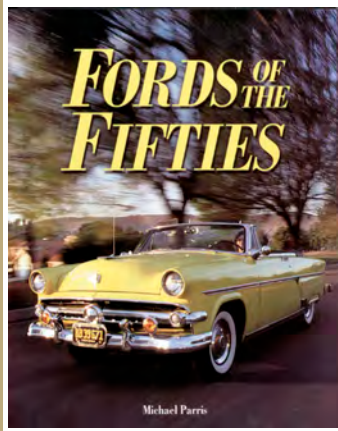

"Flathead V-8 Builders Handbook"

Part #	CA-3200-1
Author	Fisher Books
Year	1932-53
Price	24.95 ea.

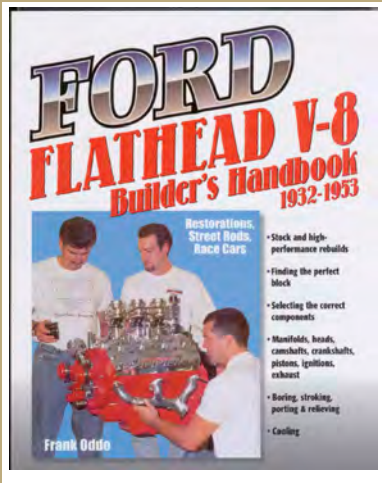

"Thunder Road Flathead Guide"

Part #	CA-3200-2
Author	Bill Sinclair
Note	Modifications on the engine ignition, electrical system, overdrive, carburetion, cooling and more.
Price	39.95 ea.

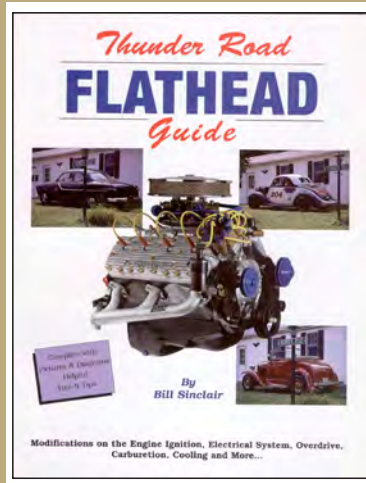

"Thunder Road Electrical Guide"

Part #	CA-3200-3
Author	Bill Sinclair
Note	Six to twelve volt conversion for all cars and trucks
Price	37.50 ea.

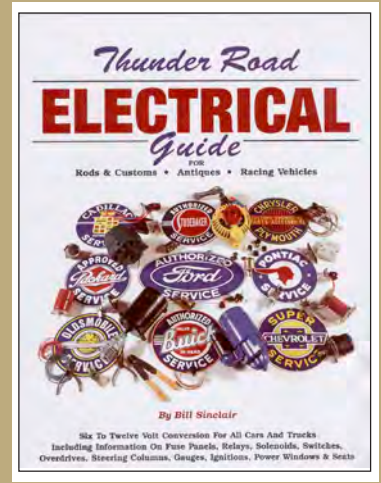

50,000 PART NUMBERS IN STOCK!

SHOP ONLINE

www.dennis-carpenter.com

FORD SHOP MANUALS

PART #	PIC	DESCRIPTION	YEAR	PRICE
CA-5200	A	Ford Shop Manual	52-54	44.95 ea.
CA-5500	B	Ford Shop Manual	55	34.95 ea.
CA-5600	C	Ford Shop Manual	56	34.95 ea.
CA-5700	D	Ford Shop Manual	57	29.95 ea.
CA-5800	E	Ford Shop Manual	58	39.95 ea.
CA-5900	F	Ford Shop Manual	59	39.95 ea.

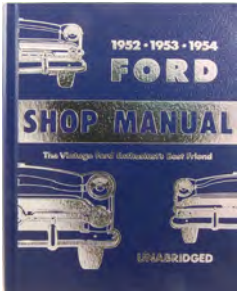

A



B



C

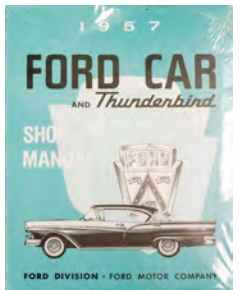

D

BODY, TRIM, & SEALANT ASSEMBLY MANUAL

PART #	PIC	DESCRIPTION	YEAR	PRICE
AM-0178	D		1955	31.95 ea.
AM-0180	E		1956	31.95 ea.
AM-0182	F		1957	29.95 ea.



D

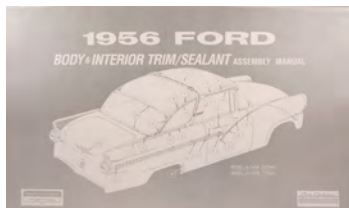

E



F

FORD OWNER'S MANUAL

PART #	PIC	DESCRIPTION	YEAR	PRICE
CA-5210	G	Ford Owner's Manual	52	9.95 ea.
CA-5310	H	Ford Owner's Manual	53	9.95 ea.
CA-5410	I	Ford Owner's Manual	54	9.95 ea.
CA-5510	J	Ford Owners Manual	55	9.95 ea.
CA-5610	K	Ford Owners Manual	56	9.95 ea.
CA-5710	L	Ford Owners Manual	57	9.95 ea.
CA-5810	M	Ford Owners Manual	58	9.95 ea.
CA-5910	N	Ford Owners Manual	59	9.95 ea.

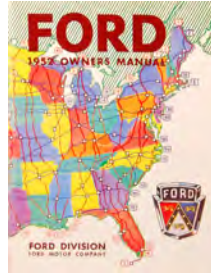

G

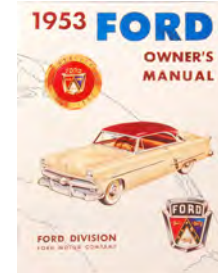

H



I



J

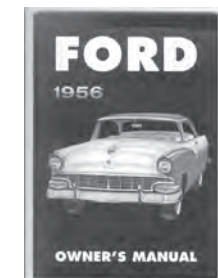

K

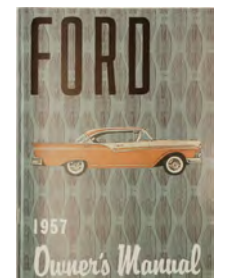

L

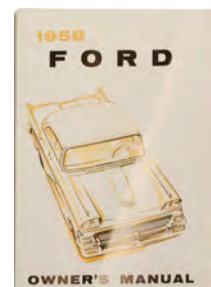

M

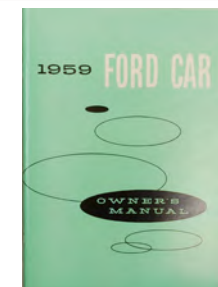

N

\$9.99 *or* **\$14.99** **FLAT RATE SHIPPING**
See shipping page for details.

WIRING DIAGRAM MANUAL

PART #	PIC	DESCRIPTION	YEAR	PRICE
CA-5234	A	Ford	52-54	5.95 ea.
CA-5534	B	Ford	55	7.95 ea.
CA-5634	C	Ford & T-Bird	56	7.95 ea.
CA-5734	D	Ford & T-Bird	57	7.95 ea.
CA-5834	E	Ford	58	5.95 ea.
CA-5934	F	Ford	59	5.95 ea.



A

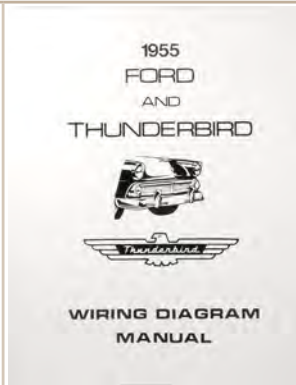

B

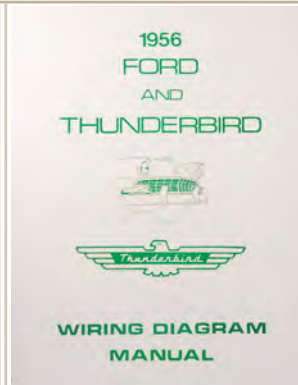

C



D

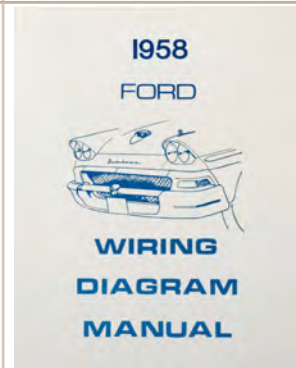

E



F

PARTS AND ACCESSORIES MANUALS

PART #	PIC	YEAR	PRICE
CA-4915-6	G	49-59	249.95 set

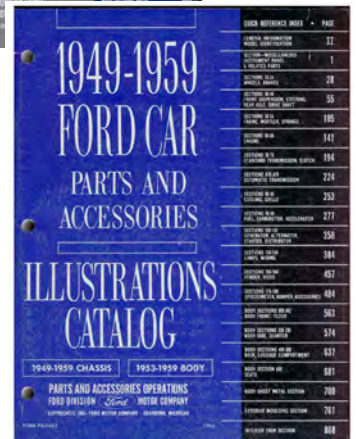
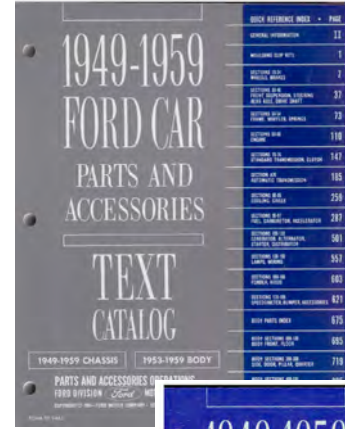

G

- 2 volumes (Text & Illustrations)

RETRACTABLE HARD TOP PARTS AND SHOP MANUALS

PART #	PIC	DESCRIPTION	YEAR	PRICE
CA-5719	H	Retractable Hard Top Parts List	1957	5.95 ea.
CA-5720	I	Retractable Hard Top Shop Manual	1957	8.95 ea.



H - 18 pages - April 1957



I

FORD MANUALS MISCELLANEOUS

PART #	PIC	DESCRIPTION	YEAR	PRICE
CA-5318	J	Ford Body Parts List	53-57	49.95 ea.
CA-5501	K	Specification & Accessories Manual	55	9.95 ea.

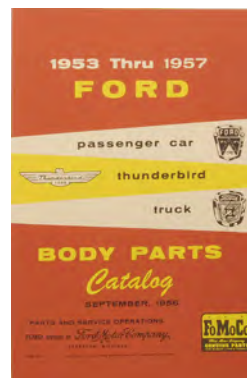

J

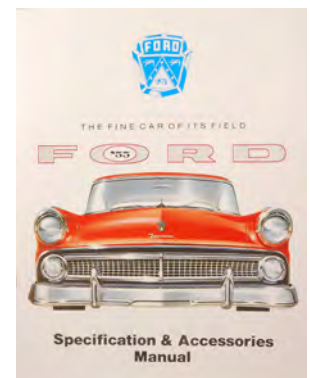

K

PASSENGER CAR TECHNICAL BOOKLETS

Brief technical booklets by Ethyl. Corporation

PART #	PIC	DESCRIPTION	YEAR	PRICE
PD-1958	A		1958	2.00 ea.
PD-1959	B		1959	2.00 ea.



Steering Wheel Restoration Book

Part #	CA-3600
Price	\$12.95 ea.



Station Wagon Living - 1959

Part #	CA-5930-5
Price	\$8.50 ea.

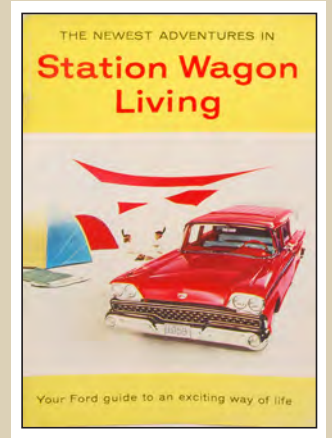

1959 Buyers Digest of New Car Facts

Part #	CA-5930-2
Price	\$10.00 ea.

Original Limited Supply



FORD - All the Facts about the '56 Ford
99 pages

Part #	CA-5632
Price	15.95 ea.

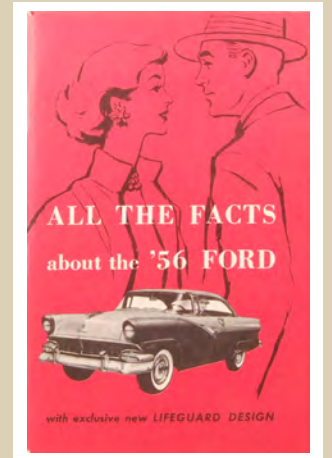

'54 FORD
Full color sales brochure
All Body Styles

Part #	CA-5430
Price	9.95 ea.

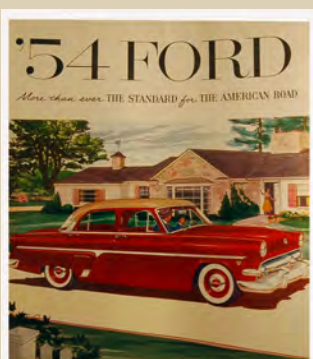

1958 Full Color Ford Fold-out Wall Poster
- All Body Styles

Part #	CA-5822
Price	\$10.00 ea.

Original Limited Supply



FORD TIMES MAGAZINES

A Ford Publication given out at local Ford dealers. Some may be soiled.

PART #	PIC	DESCRIPTION	YEAR
CA-1952-10		October 1952 Edition	4.95 ea.
CA-1952-12		December 1952	4.95 ea.
CA-1953-7		July 1953 Edition	4.95 ea.
CA-1953-10		October 1953 Edition	4.95 ea.
CA-1953-11		November 1953 Edition	4.95 ea.
CA-1954-1		January 1954 Edition	4.95 ea.
CA-1954-3		March 1954 Edition	4.95 ea.
CA-1954-4		April 1954 Edition	4.95 ea.
CA-1954-6		June 1954 Edition	4.95 ea.
CA-1954-9		September 1954 Edition	4.95 ea.
CA-1955-7		July 1955 edition	4.95 ea.
CA-1955-8		August 1955 edition	4.95 ea.
CA-1955-9		September 1955 edition	4.95 ea.
CA-1955-10		October 1955 edition	4.95 ea.
CA-1955-11		November 1955 edition	4.95 ea.
CA-1955-12		December 1955 edition	4.95 ea.
CA-1956-4		April 1956 edition	4.95 ea.
CA-1956-5		May 1956 edition	4.95 ea.
CA-1956-6		June 1956 edition	4.95 ea.
CA-1956-7		July 1956 edition	4.95 ea.
CA-1956-8		August 1956 edition	4.95 ea.
CA-1956-9		September 1956 edition	4.95 ea.
CA-1956-11		November 1956 edition	4.95 ea.
CA-1957-1	A	January 1957 Edition	4.95 ea.
CA-1957-4		April 1957 Edition	4.95 ea.
CA-1957-6		June 1957 Edition	4.95 ea.
CA-1957-10		October 1957 Edition	4.95 ea.
CA-1957-11		November 1957 Edition	4.95 ea.
CA-1957-12	B	December 1957 Edition	4.95 ea.
CA-1958-1		January 1958 Edition	4.95 ea.
CA-1958-2		February 1958 Edition	4.95 ea.
CA-1958-3		March 1958 Edition	4.95 ea.
CA-1958-4		April 1958 Edition	4.95 ea.
CA-1958-8		August 1958 Edition	4.95 ea.
CA-1958-10		October 1958 Edition	4.95 ea.
CA-1959-4		April 1959 Edition	4.95 ea.
CA-1959-5		May 1959 Edition	4.95 ea.
CA-1959-6		June 1959 Edition	4.95 ea.
CA-1959-7		July 1959 Edition	4.95 ea.
CA-1959-8		August 1959 Edition	4.95 ea.
CA-1959-9		September 1959 Edition	4.95 ea.
CA-1959-10		October 1959 Edition	4.95 ea.
CA-1959-11		November 1959 Edition	4.95 ea.
CA-1959-12		December 1959 Edition	4.95 ea.

A

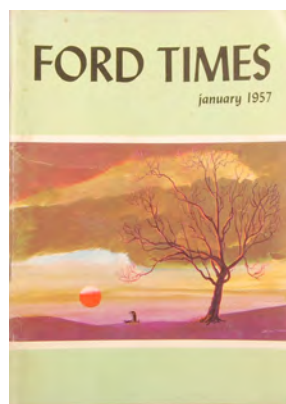

B



Ford Times are new and original. They are not reproductions.

LIMITED SUPPLY!

MAGNETIC SIGNS

PART #	PIC	DESCRIPTION	PRICE
MM-2	C	Look, But Please Don't Touch	4.95 ea.
MM-3	D	Look and Enjoy, but Please Don't Touch	4.95 ea.



C



D

FORD SCRIPT OVAL STICKER

PART #	PIC	DESCRIPTION	PRICE
DF-361		Blue on White - 3 1/2"	3.95 ea.
DF-362	E	Blue on White - 6 1/2"	4.95 ea.
DF-363	F	Blue on White - 9 1/2"	5.50 ea.
DF-364	G	Blue on White - 17"	6.50 ea.
DF-1388		Blue on Clear - 3 1/2"	3.95 ea.
DF-1389		Blue on Clear - 6 1/2"	4.95 ea.



E



F



G

357862-58

PIC	DESCRIPTION	YEAR	PRICE
	Top Belt Moulding Clip	52-54	1.95 ea.
Fits Body Styles: 59,70,72,73,78,79 Need 18-22 for Doors Need 8-16 for Quarter			

358398-58

PIC	DESCRIPTION	YEAR	PRICE
	Front Door & Fender Moulding Clip	52-53	1.95 ea.
Fits Body Styles: Fender - 60B,70B,72B,76,79B Need 10 for Fender Need 8-14 for Door			

352220-58

PIC	DESCRIPTION	YEAR	PRICE
	Rocker Panel Fastener	52-56	1.95 ea.
Fits ALL Body Styles Need 14			

352632-5

PIC	DESCRIPTION	YEAR	PRICE
	Quarter Panel Clip	53	2.95 ea.
- T- Bolt Type - 12 per car			

BM-7029144-B

PIC	DESCRIPTION	YEAR	PRICE
	Rear Door & Quarter Moulding Clip	54	2.50 ea.
Fits Body Styles: 60,70B,72B,73B,73C,76,79B Need 6 for Door Need 8-12 for Quarter			

BM-7021020-B

PIC	DESCRIPTION	YEAR	PRICE
	Front Fender & Door Moulding Clip *Roof Clip on 56 Victoria - need (16)	54	2.50 ea.
Fits Body Styles: 59B,60B,60F,70B,72B,73B,73C,76,79 Need 10-12 for Door Need 10 for Fender			

B4A-8244-A

PIC	DESCRIPTION	YEAR	PRICE
	Upper Grill Moulding Hood Lip Moulding	54-55 55	1.95 ea.

358394-5

PIC	DESCRIPTION	YEAR	PRICE
	Front of Quarter Moulding Clip - Customline - 8 per side	52-53	1.95 ea.

358552-5100

PIC	DESCRIPTION	YEAR	PRICE
	Front of Quarter Moulding Clip - 2 per side	54	2.50 ea.

352213-58

PIC	DESCRIPTION	YEAR	PRICE
	Door Garnish Moulding Clip - Hardtop & Convertible - 8 per car	53-54	2.95 ea.

B4A-8244-A

PIC	DESCRIPTION	YEAR	PRICE
	Upper Grill Moulding Hood Lip Moulding	54-55 55	1.95 ea.
Need 10 for Grill Moulding Need 9 for Lip Moulding			

B5A-7021066-A

PIC	DESCRIPTION	YEAR	PRICE
	Door & Quarter Panel Moulding Clip	55	1.95 ea.
Fits Body Styles: 59B,60B,70B,73B,76,79B - Need 8 for Door - Need 8 for Quarter			

B5A-6450022-B

PIC	DESCRIPTION	YEAR	PRICE
	Roof Outside Side Rear Moulding Clip	56	3.30 ea.

B5A-6450038-A

PIC	DESCRIPTION	YEAR	PRICE
	Roof Rail Clip	55-56	1.95 ea.

2478

PIC	DESCRIPTION	YEAR	PRICE
	Roof Rail Clip	55-56	1.95 ea.

B5A-6450116-A

PIC	DESCRIPTION	YEAR	PRICE
	Top of Roof Center Moulding Clip	55-56	3.50 ea.
Fits Body Styles: 64A,64B Need 8-10			

B5A-6403166-A

PIC	DESCRIPTION	YEAR	PRICE
	Windshield Outside Top Moulding Clip	55-56	1.95 ea.
Fits Body Styles: 64A,64B,64C Need 10			

B6A-7029144-A

PIC	DESCRIPTION	YEAR	PRICE
	Quarter Panel Clip	56	1.95 ea.
Fits Body Styles: 57,59A,64A,64B,64C,70C,73C,76,79B Need 10			

FLARE CLIP PLIERS

Used to install flare style type clips.

PART #	PRICE
TL-300	14.95 ea.



Many molding clips are a flare type design. To install a flare type clip you place the clip into position on body. Then use these specially made pliers to squeeze two outer center tabs together forcing the inner flare tabs to pinch against sheet metal thus holding the clip into place.

B5A-7021094-C

PIC	DESCRIPTION	YEAR	PRICE
	Fairlane Door Body Moulding Clip	55	2.95 ea.
	- Door - Need 2 per car.		

B5A-7021066-E

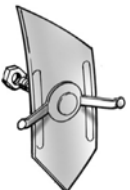
PIC	DESCRIPTION	YEAR	PRICE
	Fairlane Door Body Moulding Clip	55	2.95 ea.
	- Door - Need 2 per car.		

B5A-7021066-D

PIC	DESCRIPTION	YEAR	PRICE
	Fairlane Door Body Moulding Clip	55	2.95 ea.
	- Door - Need 2 per car.		

B5A-7021094-F

PIC	DESCRIPTION	YEAR	PRICE
	Fairlane Front of Front Body Moulding Clip	55	2.95 ea.
	- 2 Dr. and 4 Dr. Sedan - Need 2 per car.		

B5A-7021066-C

PIC	DESCRIPTION	YEAR	PRICE
	Fairlane Front of Door Body Moulding Clip	55	2.95 ea.
	- Crown, HT, Conv. - Need 2 per car.		

358566-5100

PIC	DESCRIPTION	YEAR	PRICE
	Fairlane Front Fender Moulding Clip	55	2.95 ea.
	- Front of Front Fender Moulding - Rear of Quarter Moulding - Need 4 per car		

B5A-16241-A

PIC	DESCRIPTION	YEAR	PRICE
	Front Edge of Front Fender Above Park Light Assy.	55	2.50 ea.
	All Body Styles - 10 per car		

B5A-16276-A

PIC	DESCRIPTION	YEAR	PRICE
	Fairlane Front Fender Body Moulding Clip	55-56	2.95 ea.
	- 2 for 1955 at back - 2 for 1956 at front		

B5A-7021094-A

PIC	DESCRIPTION	YEAR	PRICE
	Fairlane Front Fender Moulding Clip	55-56	1.95 ea.
	- Need (8) for 1955 - Need (4) for 1956		

B6A-7021094-A

PIC	DESCRIPTION	YEAR	PRICE
	Fairlane Front Fender Moulding Clip	55-56	1.95 ea.
	- Need (6) for 1955 - Need (4) for 1956		

B5A-7029176-A

PIC	DESCRIPTION	YEAR	PRICE
	Crown Top of Quarter Body Moulding Clip	55-56	1.95 ea.
	- Top of Quarter - Need 12 per car.		

B5A-6452182-A

PIC	DESCRIPTION	YEAR	PRICE
	Headliner Bow Support Clip	55-56	1.95 ea.
	- ex. convertible - (18) per car		

B6A-7021094-D

PIC	DESCRIPTION	YEAR	PRICE
	Fairlane Back of Door Body Moulding Clip	56	2.95 ea.
	- Back of door - Needs 2 per car.		

B6A-7021094-F

PIC	DESCRIPTION	YEAR	PRICE
	Fairlane Door & Quarter Body Moulding Clip	56	1.95 ea.
	- Door & Quarter - Need 12 per car. - 8 on door, 4 on quarter.		

2614

PIC	DESCRIPTION	YEAR	PRICE
	Front Fender & Quarter Door Moulding Clip	56	2.50 ea.

B6A-7021094-C

PIC	DESCRIPTION	YEAR	PRICE
	Fairlane Door & Front Fender Body Moulding Clip	56	2.95 ea.
	- Door & Front Fender - Need 4 per car. - back of front fender, front of door		

B5A-16249-A

PIC	DESCRIPTION	YEAR	PRICE
	Fairlane Front Fender Body Moulding Clip	56	2.95 ea.
	- Front Fender - Need 2 per car.		

2493

PIC	DESCRIPTION	YEAR	PRICE
	Fender, Door & Quarter Panel Moulding Clips	56	2.50 ea.
	Fits Body Styles: 57,59,64,70,73,76,79B Need 10 for Fender, 2-8 for Door		

FLARE CLIP PLIERS

Used to install flare style type clips.

PART #	PRICE
TL-300	14.95 ea.



Many molding clips are a flare type design. To install a flare type clip you place the clip into position on body. Then use these specially made pliers to squeeze two outer center tabs together forcing the inner flare tabs to pinch against sheet metal thus holding the clip into place.

1955 Sunliner

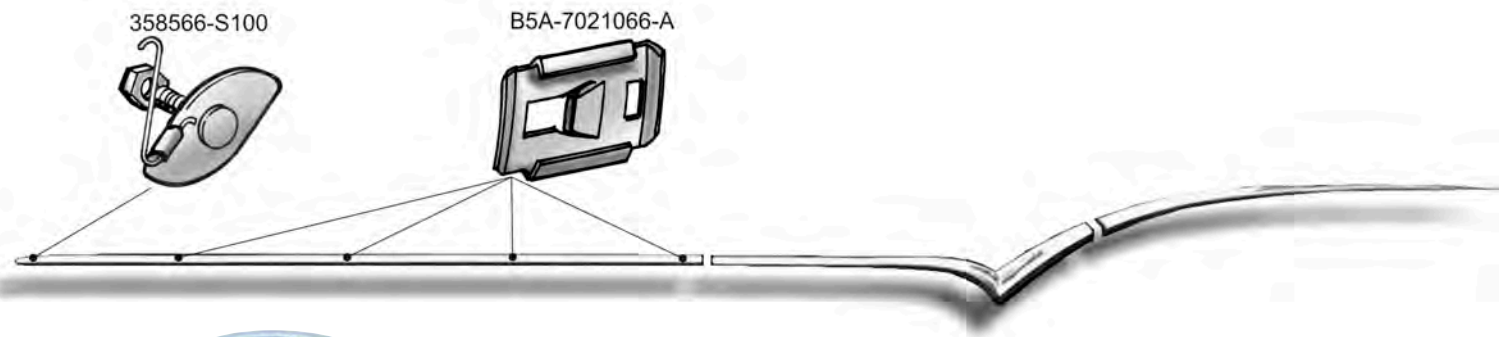
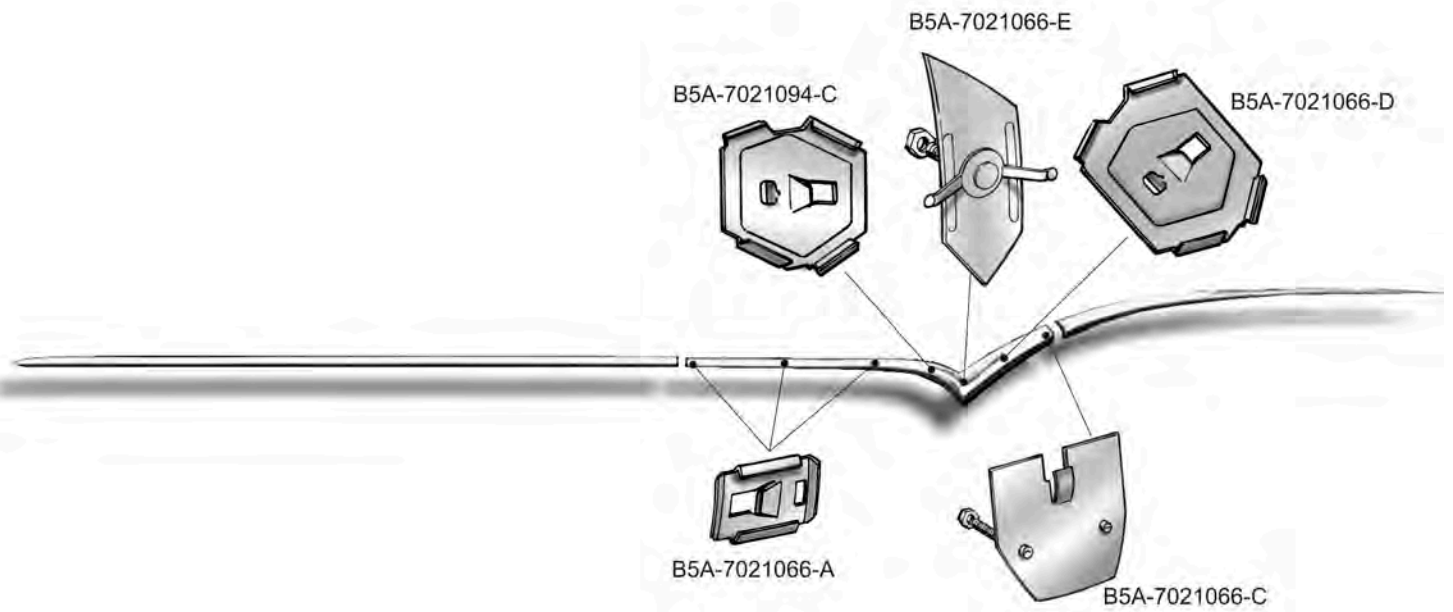
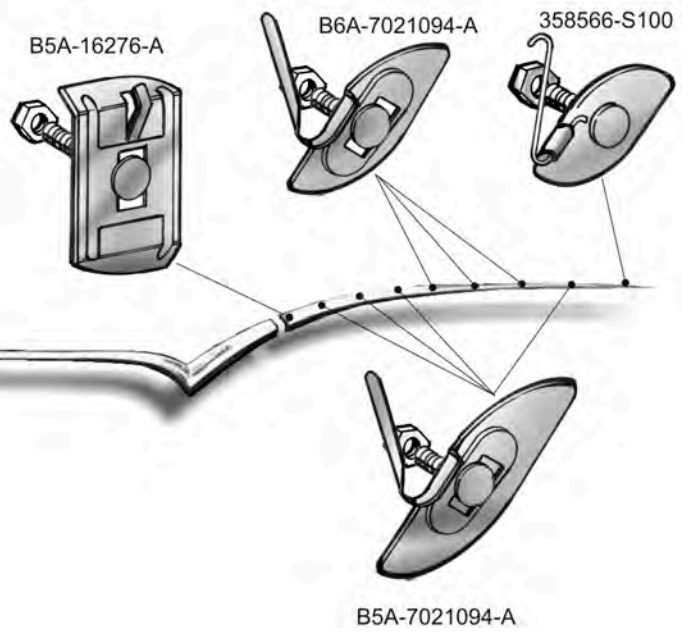

1956 Crown Victoria

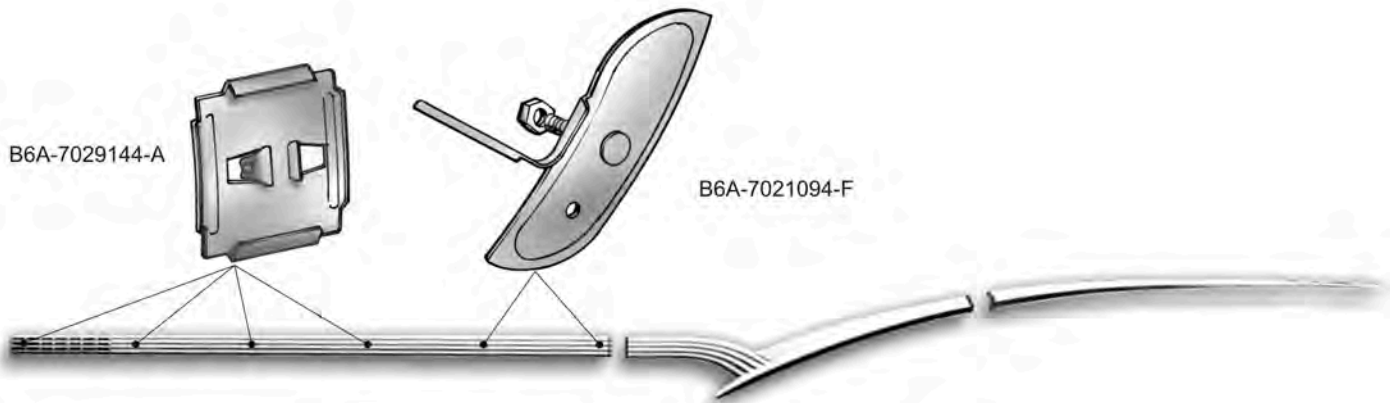
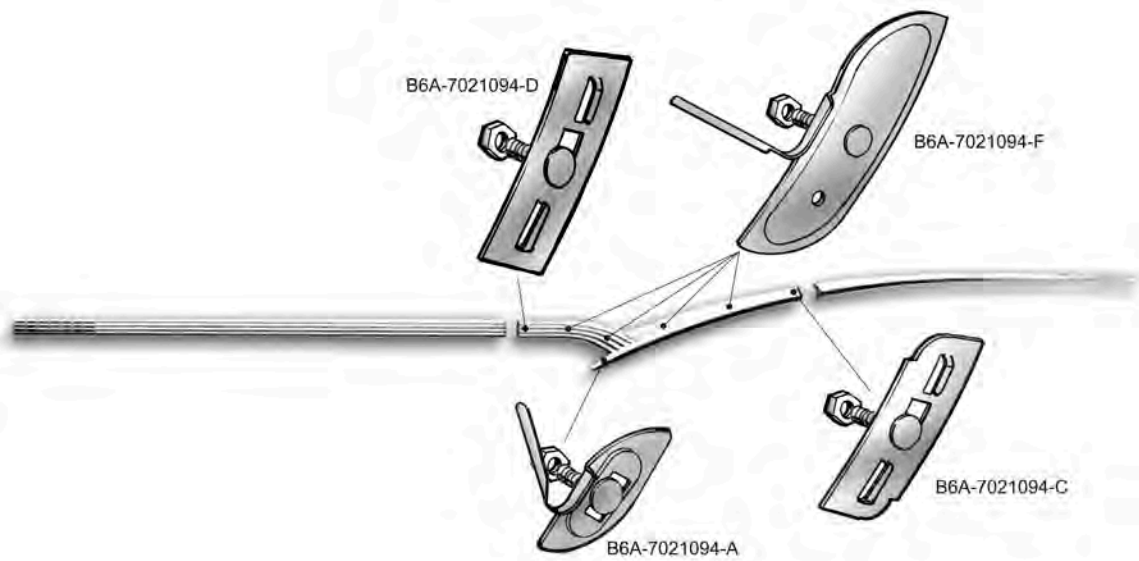
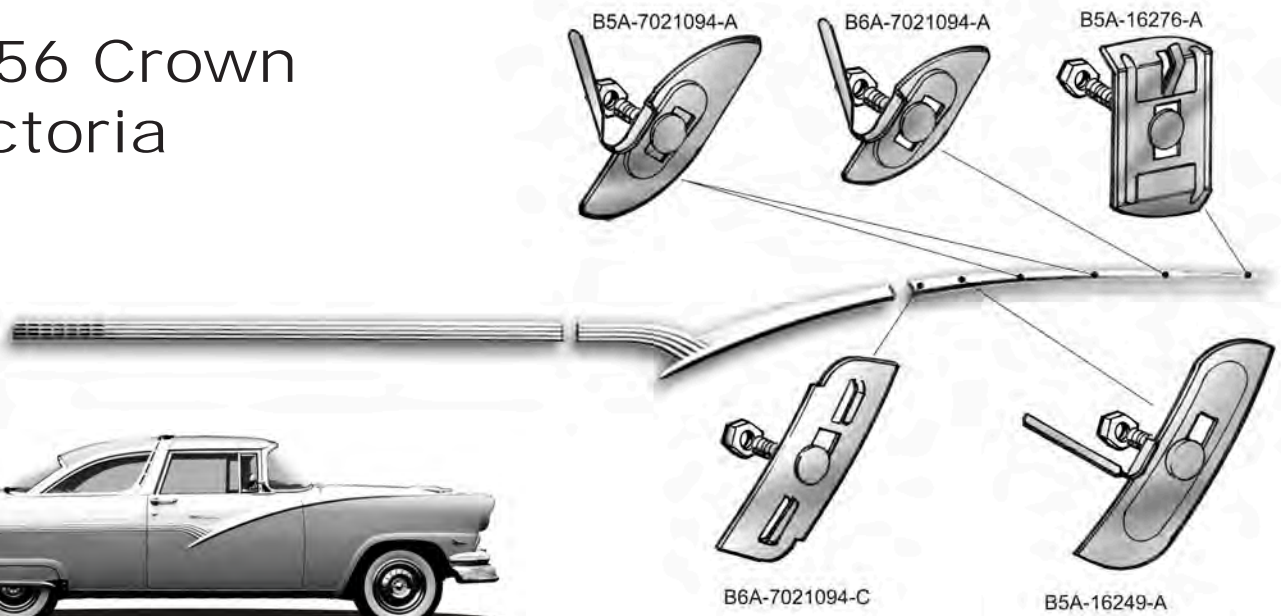

B7A-5825562-A

PIC	DESCRIPTION	YEAR	PRICE
	Top Fin Quarter Panel Moulding Clip	1957	1.95 ea.

B7A-6450024-B

PIC	DESCRIPTION	YEAR	PRICE
	Roof Rail Moulding Clip	57-58	2.50 ea.
- takes 6			

B7A-6429144-A

PIC	DESCRIPTION	YEAR	PRICE
	Quarter Panel Moulding Clip	1957	2.50 ea.

B7A-6450024-A

PIC	DESCRIPTION	YEAR	PRICE
	Roof Rail Moulding Clip	57-58	1.95 ea.
- takes 12			

B6A-7029120-A

PIC	DESCRIPTION	YEAR	PRICE
	Doors & Quarter Moulding Clips	57	1.95 ea.
Fits Body Codes: 57A, 58B, 59, 63A, 64b, 70, 73A, 73B, 76, 79C, 79D			

B7A-6421066-B

PIC	DESCRIPTION	YEAR	PRICE
	Door Trim End Moulding Clip	57-58	1.95 ea.

B7A-7029144-A

PIC	DESCRIPTION	YEAR	PRICE
	Door & Quarter Panel Moulding Clip	57-58	1.95 ea.

B6A-7021066-C

PIC	DESCRIPTION	YEAR	PRICE
	Belt Moulding, Front Fender Clip	57-58	2.25 ea.

B7A-6429144-E

PIC	DESCRIPTION	YEAR	PRICE
	Front Fender, Door, Rear Fender Moulding Clip	57-58	1.95 ea.

B7A-7021066-B

PIC	DESCRIPTION	YEAR	PRICE
	Upper Door Moulding Clip	57-58	1.50 ea.

B7A-7021066-E

PIC	DESCRIPTION	YEAR	PRICE
	Upper Door Moulding Clip	57-58	1.50 ea.

B7A-5721060-A

PIC	DESCRIPTION	YEAR	PRICE
	Top of Door Belt Moulding Clip	57-58	2.95 ea.
Fits: 4 dr. Hardtop			

B8A-7021094-A

PIC	DESCRIPTION	YEAR	PRICE
	Moulding Clips	58	1.95 ea.
20-22 - For Front Fender, 14-20 - For Front Door 18-20 - For Rear Door, 24-30 For Quarter			

#63A...#76 HUH??

What do these numbers mean in our catalog?



Various parts in this catalog are identified with Body Type Codes. A complete listing of these codes and the body types which they represent are shown on page 149.

For instance, a 54A would equal a Galaxie Town Sedan.

This code can be found on the Body Plate located on the door pillar of your car.

This way you can be sure the parts you're ordering fits your car!

B7A-5929120-A

PIC	DESCRIPTION	YEAR	PRICE
	Fender, Door & Quarter Moulding Clip	57-58	2.95 ea.
59,66B,70,78 - 57/58 Quarter - 2 per car 57B,58A - 57 Quarter - 4 per car 63B,64A - 1957 Quarter - 4 per car 73,79C,79D - 57/58 Rear Door - 2 per car 73B,79C,79D - 1958 Door - 4 per car 57B,58A - 1957 Rear Door - 6 per car 59B,66B,70,73,79C,79D - 58 Front Dr. - 2-6 per car 51A,57A,58B,63A,64B,76 - 58 Front Fender - 4 per car			

B7A-7029120-A

PIC	DESCRIPTION	YEAR	PRICE
	Fender & Quarter Moulding Clip	57	2.50 ea.
Fairlane 500 - Front Fender Lower - 10 per car Custom Quarter - 8 per car Custom 300 Front Fender - 2 per car Quarter - 12 per car			

BM-7029120-A

PIC	DESCRIPTION	YEAR	PRICE
	Door & Quarter Moulding & Rear Door Clip	58	2.95 ea.
Door & Quarter - Need (4) per Rear Door - Takes (2) per			

B7A-16794-B

PIC	DESCRIPTION	YEAR	PRICE
	Fender Moulding Clip - 7 per side - For Lower Front Fender Moulding	57 & 59	1.95 ea.

B9AB-6420262-A

PIC	DESCRIPTION	YEAR	PRICE
	Door Moulding Clip	1959	1.95 ea.

B9A-6329144-A

PIC	DESCRIPTION	YEAR	PRICE
	Lower Quarter Moulding Clip	59	1.95 ea.
Does not fit wagon - (12) per car			

B9A-5829211-A

PIC	DESCRIPTION	YEAR	PRICE
	Quarter or Rear Door Moulding Clip on Top	59	2.75 ea.
Fits Body Codes: 51A, 59, 63, 64, 65, 66C, 76B - Need 10 on quarter Fits Body Codes: 54A, 57A, 58, 71E,F,H, 75A - Need 10 on quarter & Rear Door			

B9A-5829211-B

PIC	DESCRIPTION	YEAR	PRICE
	Top Fin Quarter Panel Moulding Clip	1959	2.75 ea.
Fits all except 71G. - 4 to 6 per car			

B9A-6421094-A

PIC	DESCRIPTION	YEAR	PRICE
	Front Fender, Door Moulding Clip	1959	2.50 ea.

RJL1083

PIC	DESCRIPTION	YEAR	PRICE
	Quarter Panel Clip - Mercury	55	2.50 ea.



BULBS

PART #	PIC	DESCRIPTION	TYPE	YEAR	PRICE
B5A-13007-H	B	Headlight Bulb	6 Volt - Halogen	40-55	14.95 ea.
*B6A-13007	C	Headlight Bulb	12 volt	56-57	11.95 ea.
11A-13465-1154	D	Park Light Bulb	6 volt	42-55	1.50 ea.
B6A-13465-1034	E	Park Light Bulb	12 volt	56-59	1.50 ea.
B7A-13466-1157A	F	Park Light Bulb	12 volt - Painted Amber	56-59	1.95 ea.
B7A-13466-1157NA	G	Park Light Bulb	12 volt - Amber Glass		1.95 ea.
78-13466-55	H	Instrument Panel Bulb	6 volt	48-55	1.50 ea.
B6A-13466-57	I	Instrument Panel Bulb	12 volt	56-59	0.95 ea.
48-15021-51	J	High Beam Indicator Bulb	6 volt	49-51	1.50 ea.
78-13466-55	H	High Beam Indicator Bulb	6 volt	52-55	1.50 ea.
B6A-13466-57	I	High Beam Indicator Bulb	12 volt	56-57	0.95 ea.
78-13466-55	H	Glove Compartment Bulb	6 volt	49-55	1.50 ea.
B6A-13466-57	I	Glove Compartment Bulb	12 volt	56	0.95 ea.
11A-13465-1154	D	Taillight Bulb	6 volt	42-55	1.50 ea.
B6A-13465-1034	E	Taillight Bulb	12 volt	56-59	1.50 ea.
B-13466-63	K	Rear License Plate Bulb	6 volt	49-55	0.95 ea.
09B-13466-67	L	Rear License Plate Bulb	12 volt	56-59	0.95 ea.
B-13466-63	K	Courtesy Light Bulb	6 volt	49-55	0.95 ea.
09B-13466-67	L	Courtesy Light Bulb	12 volt	56-59	0.95 ea.
78-13466-55	H	Automatic Transmission Selector Bulb	6 volt	55	1.50 ea.
B6A-13466-57	I	Automatic Transmission Selector Bulb	12 volt	56	0.95 ea.
B-13466-63	K	Dome Light Bulb	6 volt	49-53	0.95 ea.
B6A-13730-1003	M	Dome Light Bulb	12 volt	56	1.50 ea.



FLAT RATE SHIPPING

ON ALL DOMESTIC GROUND ORDERS*
 *RESTRICTIONS APPLY. SEE ADDITIONAL DETAILS BELOW



\$99 or LESS get \$9.99 SHIPPING
\$100 or MORE get \$14.99 SHIPPING

Must ship by "ground" service within the contiguous US. (This excludes Alaska, Hawaii, and Puerto Rico. Normal carrier rates apply.)

Domestic Air and International service is not included. Normal carrier rates apply. Even though an order requires multiple packages or if any of the packages are oversized, bulky, and/or heavy, the shipping is still \$14.99 excluding items that require "Freight Truck Shipping". Any "domestic ground" order with a total parts value under \$100.00 will be charged a \$9.99 minimum shipping rate. These rates include insurance and handling.

Items such as hoods, bedsides, 12' bedstrips, doors, fenders, quarter panels require freight truck shipping. Items that require freight truck shipping are noted in catalog. If items requiring freight truck shipping are ordered with flat rate items, all items will be included for the same freight truck rate. See right for more details.

Preferred Carriers

Our preferred carriers are FedEx, UPS, and USPS for all parcel shipments. No other carriers are used. No exceptions.



Special Handling:

Retail orders requiring special handling other than flat rate ground shipping will be estimated as shown below: The prices are estimates only. Actual shipping charges will apply.

Air Shipments

	Sm. Pkg.	Med. Pkg.	Lg. Pkg.
Next Day Air:	\$40.00	\$100.00	\$200.00
Sec. Day Air:	\$30.00	\$75.00	\$170.00

Freight Truck Shipment

	Shipping Fee	Crating Fee (if applicable)
Residential Address	\$150.00	\$75.00
Commercial Address	\$150.00**	\$75.00

**Lift Gate Fees are included in estimates above and range from \$30 to \$40. Depending on carrier this fee may be waived for orders delivered to a commercial address.

Freight Truck Shipping fees above are estimates only. Actual freight shipping charges will be applied when the order is shipped and invoiced. Items that require a freight truck cannot be included with flat rate shipping.

International Shipments (All Except Canada)

When calculating shipping for international orders, please use 50% of the order total parts value or \$50.00, whichever is greater. These figures are used for estimating purposes only. The actual amount will be added when the order is shipped and invoiced. International orders are shipped by the USPS most of the time, size and weight permitting. Customs clearance will be the responsibility of the consignee.

Canadian Shipments

When calculating shipping for Canadian orders, please use 20% of the order total parts value or \$25.00, whichever is greater. These figures are used for estimating purposes only. The actual amount will be added when the order is shipped and invoiced. Canadian orders are shipped by the USPS most of the time, size and weight permitting. Customs clearance will be the responsibility of the consignee.

Merchandise Returns:

- 1) All sales are considered final with the exception of warranty claims and merchandise shipped in error.
- 2) All returned merchandise must be in original packaging and is subject to inspection and approval prior to credit or exchange. Must be in new sale condition as determined by Carpenter Industries.

It is the customer's responsibility to check parts for correct fit BEFORE installation.

Any part that has been installed, disassembled, drilled, welded, cut, painted, or modified in any way, or is missing kit components is NOT eligible for return.

Electrical items that have NOT been installed and/or plugged in are eligible for return.

Electrical items that are authorized for return are still subject to inspection and approval prior to credit and/or exchange.

No returns accepted on any literature.

Any installation, disassembly or modification by a third party on the behalf of customer does not constitute an exception to our policy. Purchaser retains full responsibility for the condition of the part.

- 3) Returns within 30 days of invoice date are acceptable, any returns received after 30 days are subject to a 20% restocking fee. Returns after 180 days are subject to a 50% restocking fee.
- 4) **Absolutely NO returns accepted after one year from date of purchase. No exceptions.**
- 5) ALL RETURNS MUST HAVE A RETURN AUTHORIZATION (RA) NUMBER. Please call 1-800-476-9653, option 2, to obtain an RA number. Please have your purchase invoice number available when calling. C.I. is NOT responsible for unauthorized returns.
- 6) All returns must be shipped "pre-paid" and fully insured. COD or collect returns will not be accepted. In cases where a return is due to our error, "pre-paid" shipping charges will be refunded.
- 7) Refunds will be issued based upon the method of payment. (i.e. cash for cash purchases, credit on a credit card for credit card purchases, etc.). On returns due to our error, your shipping expense will be reimbursed based only upon carriers charges.
- 8) All returns should be sent to: Carpenter Industries, Inc.
4140 Concord Parkway S
Concord NC 28027

Claims:

All claims must be taken up with Dennis Carpenter Restorations.

Please inspect all orders for damage and/or errors immediately upon receipt. Report all discrepancies to Carpenter Industries at 1-800-476-9653, option 2, within 7 days of receipt. No claims accepted after 7 days.

Please hold all original boxes and packaging materials for the carrier to inspect.

Warranty

We guarantee to replace or at our option, repair any product or parts which are found to be defective in material or workmanship within one year from the date of shipment. Our obligation with respect to such products or parts shall be limited to replacement or repair and in no event shall we be liable for consequential or special damages, or for transportation, installation, adjustment, or other expenses which may arise in connection with such products or parts. THIS WARRANTY EXPRESSLY MADE IN LIEU OF ANY AND ALL OTHER WARRANTIES EXPRESSED OR IMPLIED INCLUDING THE WARRANTIES OF MERCHANTABILITY AND FITNESS.



Accelerator Pedal	68
Air Cleaner.....	69
Air Deflector Seals.....	56
Air Filters	69
Air Vent.....	123
Armature - Generator	70
Arm Rest.....	149
Axle Bearing	31
Back Edge Of Vent Window Seal	146
Back-Up Light.....	96-97
Back Window Seals.....	139
Ball Joints	18
Battery Hold Down Bracket	72
Battery Hold Down Clamp Kit.....	73
Battery Tender	73
Battery Tray	72
Bearings, Main.....	45
Beauty Rings	9
Belts	61
Blades.....	113
Blue Dot.....	95
Body Bolts	151
Body Codes.....	7
Body To Frame Pad Kit.....	34-35
Brake Adjusting Screw.....	14
Brake Drums.....	13
Brake Hoses	15
Brake Light Switch.....	12
Brake Pedal Pad.....	16
Brake Pedal Parts.....	16
Brake Shoes	13
Brake Shoe Hold Down Kits	13
Brake Shoe Return Spring.....	14
Breather Screen	50
Bulbs	
All193	
Headlight	82
License Plate.....	100
Park Light	88
Taillight	88
Transmission	52
Bumper Bolts.....	115

Camshafts	43
Camshaft Thrust Plate.....	43
Carburetor	66
Carburetor Repair Kit.....	68
Carburetor Repair Kits.....	67
Carrier Bearing	30
Cigar Element & Well	98
Clutch Disc	54
Clutch Parts.....	54
Clutch Pedal Rod To Firewall Seal	54
Clutch Pilot Bearing.....	54
Clutch Pressure Plate.....	54
Clutch Release Bearing.....	54
Coat Hanger	151
Coil	78
Condensors	77
Connecting Rod Bearings.....	44
Connecting Rod Bushings.....	44
Control Arm Bushings.....	18
Convertible Top Weatherstripping ..	143, 168
Cotter Pin.....	10
Cowl Kick Panels.....	124
Cowl Lacing.....	108
Cowl Plugs.....	125
Cowl Wiring	102
Crankcase Breather Screen	50
Crankshaft Related.....	45
Crestmark Seat Emblem	163
Crossover Wiring	83
Cylinder Head Gaskets.....	39
Dash Pad.....	125
Dash Wiring.....	102
Defroster Hose	121
Dimmer Switch	84
Dipstick - Transmission.....	53
Distributor Assembly.....	78
Distributor Cap.....	76, 79
Distributor Vacuum Advance	79
Dome Light	99
Door Arm Rest.....	149
Door Emblem & Bezel	155, 162
Door Glass Anti-Rattler.....	158
Door Glass Run	158
Door Handle Pads	150
Door Handle Push Button.....	150
Door Hinge Parts.....	151
Door & Ignition Lock Set.....	151

Door Lock Parts.....	151	Front Edge Of Quarter Window Seal.....	160
Door Panel Clips.....	149	Front Fender Ornaments.....	104–105
Door Bumpers.....	141	Front Hub Bearings & Seals.....	10
Door Scripts.....	155	Front Motor Mounts.....	44
Drag Link Repair Kit.....	23	Front Mount Antenna.....	116, 117
Drain Cock.....	57	Front Of Hood Emblems.....	107
Drive Pinion Bearing.....	30	Front Shock Absorbers.....	33
Electric Fuel Pumps.....	65	Front Stabilizer.....	24
Electronic Flasher.....	88	Front Stone Deflector Seal.....	115
Electronic Ignition.....	81	Front Suspension.....	18–19
Emblems		Front Timing Cover Gasket.....	40
Door.....	155, 161	Front Universal Joint.....	53
Glove Box.....	128	Front Wheel Cylinders.....	15
Hood.....	107	Fuel Lines.....	64
Hub Cap.....	9	Fuel Pump Repair Kits.....	65
Quarter Panel.....	161	Fuel Pumps.....	65
Roof.....	167	Fuel Tank.....	62
Tailgate.....	173	Fuel Tank Sending Unit.....	63
Trunk Lid.....	165	Fuel Tank Vent Tube Seal.....	64
Engine Ground Wiring.....	44, 72	Garnish Moulding To Dash Rubber.....	125
Engine Paint.....	44	Gaskets - Exhaust.....	38
Engine Valves.....	47	Gas Lines.....	64
Equalizer Rod - Park Brake.....	16	Gas Pedal.....	68
Equalizer Shaft Bushing.....	54	Gas Tank.....	62
Exhaust Clamps.....	38	Gas Tank Door Bumpers.....	64
Exhaust Deflectors.....	39	Gas Tank Neck Grommets.....	63
Exhaust Gaskets.....	38	Gas Tank Sending Unit.....	63
Exhaust Manifolds.....	38	Gas Tank Slushing Compound.....	62
Fan Belts.....	61	Gear Shift Insulator Rubber.....	51
Fender Ornaments.....	104–105	Gear Shift Knobs.....	51
Fender Scripts.....	104	Generator.....	70
Fender Skirt.....	163	Generator Belts.....	61
Fender Stone Guard.....	163	Glass Run.....	158
Filler Cap.....	51	Glass Top Rubber.....	142, 167
Filter		Glove Box Emblems.....	128
Power Steering.....	25	Glove Box Liners.....	128
Air.....	69	Glue.....	139
Oil.....	50	Grease Cap.....	10
Firewall Insulator.....	124	Grille Assembly.....	56
Flapper Seals.....	144	Grille Extension Moulding.....	57
Flexible Fuel Line.....	64	Header Bow Seals.....	143, 168
Floor Pan Plugs.....	125	Head Gaskets.....	39
Frame Pad Kit.....	34–35	Headlight Bulbs.....	82
Front Brake Shoe.....	13	Headlight Parts.....	82, 83
Front Door Glass Anti-Rattler.....	158	Headlight Switch.....	84
Front Door Window Lift Channels.....	156	Heater Hose.....	121

Heater Parts	119-120	Key Blanks.....	29
Hole Plugs	125	Key Chains	29
Hood Bumpers.....	108	Kick-Down Switch.....	55
Hood Emblems.....	107	Kick Panels.....	124
Hood Hinge.....	109	King Pin Bolt Set.....	21
Hood Letters	106	Led Bulbs.....	88
Hood Ornaments	106	License Plate	100-101
Hood Pull Cable.....	108	Lower Ball Joints	18
Hood Scoop.....	106	Lower Control Arm Bushings	18
Hood Scripts	106	Lower Door Bumpers.....	141
Horn Button	28	Lower Front Of Quarter Window Pads ...	160
Horn Relay.....	29	Lower Radiator Hoses	60
Horn Rings.....	28	Lower Steering Worm Cup	26
Horn Wiring.....	29	Lower Suspension Bumpers.....	18
Hose Clamps - Radiator	60	Lower Suspension Shaft Kit	21
Hoses		Lug Nut Protectors.....	11
Defroster.....	121	Lug Nuts	11
Heater.....	121	Magnetic Signs	183
Power Steering.....	25	Main Bearings.....	45
Radiator	60	Manifolds - Exhaust.....	38
Wiper	112	Manuals.....	181
Hub Bearings.....	10	Master Cylinder	12
Hub Bolts	11	Master Cylinder Parts.....	12
Hub Parts.....	10	Master Cylinder Repair Kit.....	12
Hup Cap	9	Mirrors	114
Idler Arm Kits	22	Motor Mounts.....	44
Ignition Coil.....	78	Neutral Safety Switch	52
Ignition Condensers.....	77	Odometer Bezel.....	129
Ignition Cylinder Assembly	73	Oil Filler Cap.....	51
Ignition Key Blanks	29	Oil Filter	50
Ignition Points.....	76	Oil Pan.....	50
Ignition Rotor	76	Oil Pan Gasket Set.....	41
Ignition Switch Housing	73	Oil Pumps	50
Ignition Tune-Up Kit.....	77	Oil Pump Screen	51
Inner Control Arm Bushings.....	18	Outer Beauty Rings	9
Inner Dog Leg Seal.....	141	Outer Tie Rod End.....	23
Inner Tie Rod End.....	23	Outer Wheel Bearings	10
Inner Wheel Bearings.....	10	Outside Door Handle	150
Inside Door Handle.....	150	Outside Rear View Mirror	114
Inside Rear View Mirror	114	Overdrive Parts.....	55
Instrument Cluster Dial Set.....	129	Overdrive Wiring.....	55
Instrument Panel Wiring	131	Overhaul Gasket Set	40
Intake Manifold Gasket.....	41	Padded Dash.....	125
Interior Trim Screw Kits	169	Paint	44
Junction Blocks.....	102	Pan Gasket Set	41
		Park Brake.....	17

Park Brake Parts	16, 17	Retractable Trunk Lid Seals	145
Park Light	85-86	Return Spring - Brake Shoe	14
Parklight Wiring	88	Ring Gear - Starter	73
Parts, Crankshaft Related	45	Rings	42
Pedal Return Spring	68	Rocker Arm Parts	46
Pilot Bearing	54	Rocker Panel Mouldings.....	133
Pinion Bearing	30	Rocker Panels	133
Piston Rings	42	Rod Bearings.....	44
Plenum	118	Roof Emblem.....	167
Plug Wires	80	Roof Rail.....	142, 167
Points.....	76	Roof Rails - Retractable	144
Powergen Generator / Alternator.....	70	Roof Script.....	167
Power Steering Parts.....	25	Rotor.....	76
Power Window Drive Coupling.....	157	Screw Kits - Interior Trim	169
Power Window Switch.....	148	Scuff Plates	132-133
Pressure Plate.....	54	Seat Emblems	163
Pressure Sending Units.....	51	Sector Shaft Seal.....	27
Pulleys.....	58	Shackle Kits.....	33
Pump Pulleys.....	58	Shift Arms	51
Push Rods.....	46	Shift Indicator Dial	129
Quarter Panel Moulding.....	161	Shift Knobs	51
Quarter Window Anti-Rattler.....	159	Shock Absorbers	33
Quarter Window Seal	159	Slushing Compound	62
Radiator Air Deflector Seals	56	Spare Tire Parts.....	11
Radiator Cap	56	Spark Plug Wires.....	80
Radiator Hoses.....	60	Speedometer Cable.....	110
Radiator Splash Shield Pads.....	57	Speedometer Driven Gear.....	110
Radiator Support To Frame Pad.....	57	Speedometer Faces	110
Rear Axle.....	30	Spindle Bolt & Bushing Kit.....	21
Rear Axle Bearing.....	31	Splash Apron Seals	104
Rear Brake Shoe.....	13	Spring Parts.....	32
Rear License Plate Light Assemblies	100	Stabilizer Bar Bushing & Bracket Kit	24
Rear Motor Mounts.....	44	Stabilizer Bar End Repair Kit.....	24
Rear Shock Absorbers.....	33	Stabilizer To Frame Bushings.....	24
Rear Spring Shackle Kits.....	33	Stainless Exhaust Deflectors.....	39
Rear Stone Deflector Seal.....	115	Starter Parts	75
Rear Universal Joint	53	Starter Ring Gear	73
Rear View Mirror.....	114	Starter Solenoid.....	75
Rear Wheel Cylinders.....	15	Starter To Flywheel Housing Seal	75
Rear Window Seals.....	139	Star Wheel Adjusting Screw	14
Rebuilt Carburetors	66	Steel Fuel Line.....	64
Rebuilt Distributor	78	Steering Box.....	27
Regulator Roller Assembly	157	Steering Box Gasket Set.....	27
Related, Crankshaft.....	45	Steering Column.....	26
Release Bearing - Clutch.....	54	Steering Column Bracket Insulator.....	27
Retractable Roof Rails.....	144	Steering Column To Floor Seals.....	27
		Steering Gear Parts.....	26, 27

Steering Worm Cup	26
Steering Worm Shaft	27
Stone Deflector Seal.....	115
Stop Light Switch.....	12
Sunray Emblem.....	9
Suspension Bumpers	18

Switches

Brake Light	12
Dimmer.....	84
Tailgate Ornament	173
Taillight Reflector	94

Taillights

1952-55	89
1956 & Mercury	91
1957-58	92
1959	93

Temperature Sender Units.....	61
Thermostats.....	61
Thrust Plate	43
Tie Rod Ends.....	23
Timing Chain	43
Timing Cover Gasket.....	40
Timing Gear - Camshaft	43
Timing Gear - Crankshaft	45
Top Switch Wire.....	168
Transmission Dipstick.....	53
Transmission Gasket Set	53
Transmission Shift Arm.....	51
Trim Rings	9
Trunk Key Blanks	29
Trunk Lid Emblems.....	165
Trunk Lid Seal	142, 164
Trunk Lock.....	165
Trunk Mat	164
Trunk Side Boards.....	164
Tune-Up Kit	77
Turn Signal Parts.....	95
Turn Signal Flasher	88
U-Bolts.....	32
Under Dash Cowl Kick Panels.....	124
Universal Anti Rattler	159
Universal Door Glass Anti-Rattler.....	159
Universal Joint.....	53
Upper Ball Joints	18
Upper Control Arm Bushings.....	18
Upper Door Glass Bumper	147

Upper Radiator Hoses	60
Upper Steering Worm Cup	26
Upper Suspension Bumpers.....	18
Upper Suspension Shaft Kit	21
Vacuum Advance.....	79
Valve Grind Gaskets.....	41
Valve Guides	47
Valve Keepers	47
Valves	47
Valve Stem Extension.....	11
Valve Tappets	46
Ventilator System Parts	123
Voltage Reducer.....	71
Voltage Regulator	71
Washer Reservoir	113
Water Pump Belts.....	61
Water Pump Repair Kit.....	58
Water Pumps.....	58
Weather Stripping.....	134-143
Weatherstripping Glue.....	139
Wheel Bearings	10
Wheel Cylinder Assembly.....	15
Wheel Nut.....	11
Window Drive Coupling	157
Window Lift Channel Weatherstripping ..	157
Window Regulator Roller Assembly	157
Window Seals.....	139
Windshield Post To Door Seal	136
Wiper Hose.....	112
Wiper Pivot Parts.....	112

Wiring

Cowl	102
Dash	102
Generator	103
Headlight Bucket	83
Heater.....	120
Instrument Panel Wiring	131
Overdrive.....	55
Parklight	88
Retractable	145
Taillight	89
Top Switch	168
Turn Signal	95

FORD RESTORATION PARTS
**DENNIS
 CARPENTER**

BEST SELLERS

IGNITION & DOOR LOCK CYLINDER SET
 BAAA-7022050-S

Fits all except
 Retractable.

1952-58
\$49.95 SET



TRUNK LID EMBLEM

Made in the USA by Dennis Carpenter



'56 FAIRLANE
 B6A-7042514-A
\$74.95 EA.



**"MUSTARD TOP"
 IGNITION COIL**



1956-74
 B6AZ-12029
\$39.95 EA.

SCUFF PLATES

1952-54
2 - DOOR



Manufactured exactly as
 Original in our Shop.
 Complete with
 Installation Screws.



Additional scuff
 plates from
 1952 to 1959,
 2 Dr. and 4 Dr.
 See pg. 128 for more

BA-7013208-PR
\$114.95 EA.



4140 Concord Parkway So.
Concord NC 28027



Competitor Brand

- Made kinda like original
- Cheap Materials
- Cracks and fades

VS.



Carpenter Brand

- Exact fit and mold
- Made exact of original
- Quality Materials
- Long Lasting

After 6 months
outside in the sun.



PREMIUM_{LINE}
WEATHERSTRIPPING
by Dennis Carpenter



With over forty-five years of experience Dennis Carpenter is the leading manufacturer and distributor of superior quality Ford weatherstripping and molded rubber parts. Our rubber extrusion department is capable of manufacturing 25,000 feet of specially formulated EPDM rubber to make our quality windshield and rear window seals.

Made Right, Fits Right, Lasts Longer

4140 Concord Parkway South Concord, North Carolina 28027 U.S.A. PH. 704.786.8139 800.476.9653 EMAIL: info@dennis-carpenter.com

Vent Window Seals after 6 months in our testing labratory (ie. Outside exposed to the elements)